

# **BRITPART**

---

---

The quality parts for Land Rovers



**20<sup>th</sup>**  
**Edition**







**W**elcome to our 20th Edition of the Britpart Accessory Catalogue.

This new edition is packed with **over 600 new parts**. Many of the new parts are for the latest Land Rover models but with plenty of exciting new accessories for the older range of vehicles too. You'll be able to personalise your Land Rover to your exact needs and wants.

Britpart also stock a vast range of repair parts, many of which are featured in this catalogue, to help Land Rover owners across the world to keep their vehicles going both on and off-road.

At Britpart we are always adding new and exciting products to our accessories range, so remember to look at [www.britpart.com](http://www.britpart.com) for all the latest additions. Also worth remembering is that if there is no picture in the catalogue of a product, then visit our website as there are plenty more product pictures online.



Photo by Johan de Villiers

<b>01</b>	Exterior Protection	9 - 26	<b>12</b>	Suspension & Axle	163 - 188
<b>02</b>	Side & Rear Steps	27 - 32	<b>13</b>	Diagnostics	189 - 194
<b>03</b>	Racks & Roll Cages	33 - 48	<b>14</b>	Repair & Service	195 - 216
<b>04</b>	Wheels	49 - 62	<b>15</b>	Lucas Classic	217 - 224
<b>05</b>	Lighting	63 - 80	<b>16</b>	Chassis & Body	225 - 240
<b>06</b>	Towing	81 - 88	<b>17</b>	Service Kits	241 - 246
<b>07</b>	Interior Protection	89 - 102	<b>18</b>	Consumables	247 - 264
<b>08</b>	Seats & Trim	103 - 116	<b>19</b>	Tools	265 - 276
<b>09</b>	Off-Road	117 - 128	<b>20</b>	Enhancements	277 - 310
<b>10</b>	Winches	129 - 142	<b>21</b>	Camping	311 - 326
<b>11</b>	Performance	143 - 162	<b>22</b>	Miscellaneous	327 - 360



Our commitment  
to you...





**F**or over 40 years Britpart has been supplying quality parts and accessories for Land Rover users across the world. We are very proud to announce that all\* Britpart parts and accessories will be backed by an industry leading 24 month guarantee.

With a recent multi-million pound investment in the best Land Rover products and with extensive investment in new staff, equipment and procedures we are convinced this guarantee will give consumers confidence in Britpart products. This is backed up with our approval by Lloyd's Register Quality Assurance to ISO 9001:2015.

This pioneering guarantee will cover over 28,000 parts from our extensive parts catalogue, from springs to clutches and winches to shock absorbers, confidence in the products we supply is assured. If any part is found to be defective following an inspection by our quality team due to faulty materials or workmanship then that part will be replaced free of charge.

With this significant development in Britpart's philosophy we are now confident that the parts the end users fit to their Land Rovers will deliver time after time, whether the customer is buying a part for a Series 3 or a new Range Rover, they are backed by the same 24 month guarantee.

Look out for the Britpart Guarantee Logo which is a constant reminder to the customer they are fitting the best available parts and accessories to their Land Rover.

\*Subject to our standard terms and conditions. Proof of purchase required by the original point of purchase. Excludes reconditioned gearboxes & engines. This guarantee does not affect your statutory rights.







Now you've seen what we look like from the outside, why not have a look inside? [www.britpart.com/fly](http://www.britpart.com/fly)

# **BRITPART**

The quality parts for Land Rovers

[www.britpart.com](http://www.britpart.com)





A world of Land Rover **parts** & **accessories**  
all under one (well several) roofs!



## The Marque

For over 40 years Britpart has been supplying quality parts and accessories for Land Rover vehicles, in that time we have become known as the leading independent wholesaler. With over 1,000 stockists worldwide, from government agencies to trade outlets our customers recognise us as a brand that can be trusted and relied upon time and time again.

# BRITPART

The quality parts for Land Rovers

Our commitment to quality and customer service is at the forefront of our operations, with the Britpart logo a highly respected marque that embodies excellence in the field. Our ethos of continuous innovation ensures that we work hard to bring the best solutions to Land Rover owners around the world.

## Products

With years of experience, our purchasing team swiftly reacts to the demands of the Land Rover parts markets. Britpart strives to provide our stockists with exactly what they want, when they want it, with many parts simply unavailable from other sources.

We recognise that Land Rover owners want to have many options when customising their vehicles. Our extensive range of accessories means that customers will always find something to suit their individual tastes and lifestyles. With our products, you can create a completely bespoke Land Rover!

Land Rover appointed Britpart as an 'Approved European Parts Distributor' for all Land Rover Genuine Parts. This, together with Britpart's vast range of parts, accessories, and extensive inventory of O.E.M. products, has resulted in Britpart becoming the ultimate 'One-Stop-Shop' for Land Rover parts. Providing everything our customers could possibly require, all ordered and delivered from one dedicated source.

## Quality

Britpart is approved by Lloyd's Register Quality Assurance to ISO 9001:2015, demonstrating our commitment to supplying quality parts and accessories for Land Rover users across the world.



We take pride in offering very competitive prices complemented by excellent customer service. Through maintaining high levels of stock we are able to fulfil orders promptly, whatever part you may require.

Our industry-leading 24 month guarantee means that we are confident

that the parts end-users fit to their Land Rovers will deliver time after time, whether the customer is buying a part for a Series 3 or a new Range Rover, they are backed by our guarantee.

## Distribution

The extensive warehouse facilities at Britpart HQ in Shropshire, UK oversee the distribution of Land Rover parts and accessories around the globe. With hundreds of vans and lorries passing through each week, our warehouse has a continual flow of Land Rover parts and accessories to serve our customers.



The fleet of Britpart vans and trucks deliver directly to Britpart stockists throughout the UK and Europe, adding to the personal touch that customers have come to associate with Britpart. We also work with the major carrier companies to dispatch our parts and accessories to stockists in every corner of the globe. No matter what part is required, or where in the world, Britpart will make sure to get it there!

## Global

When Land Rover finally severed its association with Santana Motor SA it was Britpart who bought up all the existing stock from the factory in Spain and shipped it to their UK headquarters in Shropshire. The shipment included everything from small components to body panels and new engines, along with all the original drawings and tooling. Some of the stock was found to be interchangeable with Land Rover parts and a proportion of the rest is gradually making the journey back home with the assistance of our partner in Spain, Britpart España, Estañi Automoción. Britpart's other partners around the globe include: Britpart France, Britpart Belgium, Britpart Brazil, Britpart USA, and Britpart Poland. Britpart is seeking to further expand its comprehensive customer base overseas and is continually looking for well established independent stockists of Land Rover parts to work closely with.

## Service

Providing the best service to our customers is at the heart of our ethos, and our team is always willing to go the extra mile for our valued customers. Our enthusiastic and highly knowledgeable team is always on hand to assist with enquiries and facilitate the dispatch of goods to our customers. With years of experience, you will deal with people who have an in-depth knowledge of the business. The sales operation boasts three specialised sales teams; one each for Home, European, and Export markets, each with their own technical experts. Our Export team speaks several languages meaning that we can assist you in Spanish, French, German, Mandarin, Arabic, and many other languages. Customers can also place orders through our online portal, making it easier than ever to place orders at the most convenient time for you.

## Handmade

Our modern Trim Shop operation produces a wide range of handmade seats, seat covers, bases, backs, and benches for Land Rovers. The highly skilled team ensures that the trim products are produced to the highest standards using quality materials. Our trim products are built with comfort and quality in mind, meeting the strictest safety regulations. Our Lock Shop Team also carries out a wide range of light engineering on site.



## Quality Parts

From o-rings and oil seals to engines and exhausts, Britpart holds in excess of 28,000 stock items. Choice is key for our customers, who can choose from Britpart, O.E.M., or Land Rover Genuine Parts all at competitive prices.

With such an extensive stock holding, we have everything required for servicing, repairing, restoring, and even rebuilding a Land Rover, whether it is an old Series or a modern Range Rover. Thus enabling customers to order all they need on just one order sheet making it easy to keep track of stock and take delivery.



## Quality Accessories

Whether you need accessories for an over-landing trip or want to make your Land Rover stand out from the crowd - Britpart has all the latest accessories to create a bespoke vehicle, whatever the model.

In line with our commitment to quality, we ensure that every accessory has undergone rigorous testing and meets the highest safety standards. To complement our Britpart accessories, we also stock accessories from leading brands such as ARB, Ring, Corbeau, Dynamat, Ravenol, Alcon, and many more.







# EXTERIOR PROTECTION

Protection From  
Hidden Dangers



# EXTERIOR PROTECTION

## Chequer Plate



DA2054



DA2062



DA2066 / DA4049



DA2070



DA4049



DA4049B



DA4049S



DA4073 / DA4072

### Defender - Natural Aluminium Finish

DA2054	Bumper top plate	Single
DA2062	Bumper top plates	Pair
DA2060	Mudflap brackets	Pair
DA2061	Rear cross member	Single
DA2063	Rear floor - 110 CSW	Single
DA2064	Rear sides - 110 CSW	Pair
DA2067	Rear door - without wiper	Single
DA2068	Rear door - wiper - late	Single
DA2069	Rear door - wiper - early	Single
DA2070	Load bay liner	Kit
	90/Pickup/Hard top/County Station Wagon	
DA4072	Sills - 90	Pair
DA4073	Rear wing - 90	Pair
DA4100	Sills - 110	Pair
DA4071	Rear wing - 110	Pair
DA4049	Wing tops	Pair
DA4049S	Wing tops - Note - painted silver finish	Pair

DA2066	Bonnet protector	
	Defender - 1983 - 2006	
	Curved plate - pre-drilled holes	
DA4342	Bonnet protector	Kit
	Defender - 2007 onwards	

### Defender - Satin Black Finish

DA4072B	Sills - 90	Pair
DA4073B	Rear wing - 90	Pair
DA4100B	Sills - 110	Pair
DA4071B	Rear wing - 110	Pair
DA4049B	Wing tops	Pair
DA3081	Bonnet protector	
	Defender - 1983 - 2006	Single
	Curved plate - pre-drilled holes	

DA4343	Bonnet protector	Kit
	Defender - 2007 onwards	

### Defender Chequer Plate Kits -

Kit contains - bonnet, wings, sills & rear corner protection

#### Natural Aluminium Finish

DA4296	Defender 90 - up to 2006	Kit
DA4297	Defender 110 - up to 2006	Kit

#### Black Finish

DA4296B	Defender 90 - up to 2006	Kit
DA4297B	Defender 110 - up to 2006	Kit



DA4296



Many more chequer plate images at  
[www.britpart.com/plate](http://www.britpart.com/plate)



DA2067



DA2068



DA2069

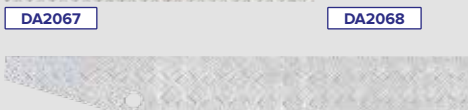

DA2061



DA2060

### Series - Natural Aluminium Finish

DA2004	Wing top	Pair
DA2050	Rear cross member	Single
DA2051	Load bay liner - short wheel base	Kit
DA2052	Sills - short wheel base	Pair
DA2053	Sills - long wheel base	Pair
DA2620	Deep sills - 2A - short wheel base	Pair
DA2054	Bumper top plate	Single
DA2067	Rear door - without wiper	Single
DA4074	Rear wing - short wheel base	Pair

Miscellaneous	Natural Aluminium Finish	
DA2065	Chequer plate sheet	Single
	1,200 x 2,500mm	

Add some **heavy-duty** protection  
to your Land Rover



DA4343

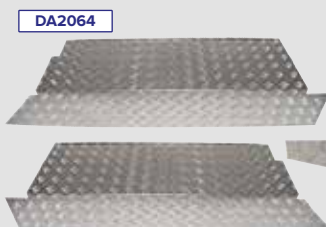

DA2064

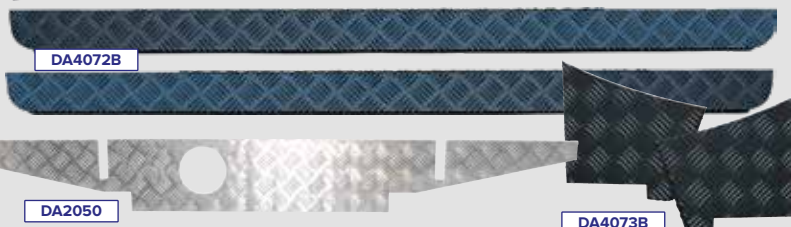

DA4072B

DA2050

DA4073B



### Bumpers & Bumperettes



<b>DA8600</b>	Defender	Front bumper with Ring LED lights
<b>DA8600XS</b>	Defender	Front bumper with Ring LED lights and rubber end caps
<b>DA8600LED</b>	Defender	Ring LED lights - pair
Fitted with 5 x 1.5w ultra bright LEDs / Dimensions - 57 H x 145 W x 55mm D		
Voltage - 12 - 24V DC / Watts - 15W		
<b>DA9500</b>	Defender	Front bumper with LED lights
<b>DA9500XS</b>	Defender	Front bumper with LED lights and rubber end caps
<b>DA9500LED</b>	Defender	LED lights - pair
Fitted with 8 x ultra bright LEDs / Dimensions - 28 H x 140 W x 47mm D		
Voltage - 10 - 30V DC / Watts - 4W		

*These smart and functional standard fit Defender bumpers are equipped with a pair of LED lights for additional lighting in the dark or day light running for safety.*

<b>DPB000270</b>	Defender	Military front bumper
<b>DPB000270GALV</b>	Defender	Galvanised military front bumper
<b>RRC6681</b>	Defender	Centre pin for bumper
<b>KNR500010</b>	Defender	'R' Clip for centre pin
<b>DA5626</b>	Defender	Bumper kit - contains all the above part numbers
<b>LR062058S</b>	Defender	Front bumper with silver finish
<b>NRC9211</b>	Defender	Front bumper with galvanised finish
<b>DA8601</b>	Defender	Front bumper rubber end cap kit
2 x end caps and fixings		
<b>RTC4769</b>	Defender/Series	Galvanised front bumperette - single

#### Defender Bumper Fitting Kits

<b>DA1171K</b>	Easier fitment plates which replace the standard fitted spring clip plates. With stainless steel bolt set.
<b>DA1171</b>	Easier fitment plates which replace the standard fitted spring clip plates. Without bolt set.
<b>ALQ710040K</b>	Tapping blocks & stainless steel bolt set
<b>DA1269</b>	Tapping blocks & bumper bolt kit
<b>DA1268</b>	Bumper bolt kit
<b>DA1139</b>	Bumper bolt kit - stainless steel



Photo by Jay Johansen



# EXTERIOR PROTECTION

## Front Protection

### A-Bars



**VPLPP0060LR**  
Defender - no winch  
Black rubber - Includes spot light brackets

**VPLPP0061LR**  
Defender - with winch  
(genuine winch bumper only)  
Black rubber - Includes spot light brackets

**VUB501980**  
Range Rover Sport - 2005 - 2009  
Moulded grey plastic - No spot light brackets

**IMPORTANT NOTICE**  
Please check local legislation before fitting a frontal protection device to a vehicle that is to be used on public roads.



## Exterior Protection Accessories

### Locking Fuel Cap



**DA1227**  
Defender - from XA159807  
Discovery 2  
Locking fuel cap  
Supplied with 2 keys.  
*Add some extra protection to your fuel.*

### Tamper Proof Nuts & Bolts



Secure your accessories



**DA7332**  
Ensure your precious accessories remain firmly on your Land Rover by using a set of these stainless steel tamper proof nuts and bolts. Ideal for securing your winch and front bumper. Each set contains either 4 nuts or bolts and 1 key.

**DA7330** M6 nut set & key  
**DA7331** M8 nut set & key  
**DA7332** M10 nut set & key  
**DA7333** M10 x 110 bolt set & key  
**DA7334** M10 x 35 bolt set & key

### Security Marking Kit



**DA8533**  
The International Security Register (ISR) system has proved successful in deterring and detecting theft and fraud for over 30 years. It works on the principle that if a vehicle's windows and parts are marked using robust techniques and details are recorded on a secure database - supported by a 24/7 verification service - criminals stealing the vehicle will run a real risk of being caught and prosecuted. Each mark applied to a vehicle will contain a unique 8-digit code, the ISR logo and [www.isrcodecheck.com](http://www.isrcodecheck.com)

- Pack Components**
- > Full instructions on marking and registering a Land Rover are in the security marking kit.
  - > 8 vinyl stencils, fluid and brush for marking windows.
  - > 2 warning decals.
  - > 2 sets of 6 UV self-etch labels for application to painted metal body panels.
  - > 2 sets of 7 ultra-destruct labels with UV fluid and applicator for identifying plastic parts.
  - > A set of three Britpart branded security tags for increasing the chance of items that are so often mislaid, being returned to the owner.
  - > A Britpart branded ISR customer contact card.

**Registration of Vehicle and Owner Data on the ISR**  
The vehicle owner - or the stockist - would complete the registration process online via the Britpart registration page at [www.TheISR.org](http://www.TheISR.org) then select "All Vehicles" then "Vehicles" followed by "Britpart Registration Form" entering the unique code together with the vehicle make, model, colour, VIN and VRM together with the owners name and contact details. If an email address is supplied, an automated acknowledgement of registration would be sent. The code for the security tags would be automatically recorded.  
More details of the kit can be found at [www.britpart.com/security](http://www.britpart.com/security)



Defender



DA4077



DA1079



DA4400



STC53161

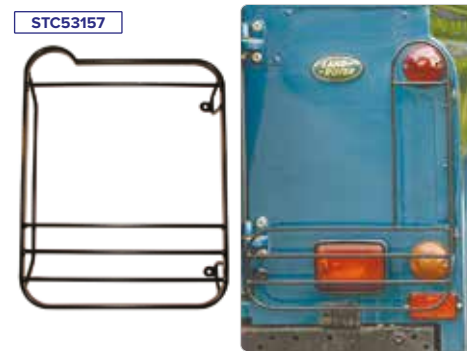

STC53157



STC53158



DA4349

<b>DA4077</b>	Defender - all models	Front	Wolf style	Pair
<b>DA1079</b>	Defender - 2003 - 2006 & 2007 onwards	Rear	Wolf style - rectangular & round	Pair
<b>DA4400</b>	Defender - Td5 - 2003 onwards	Front & rear	Wolf style	Kit
<b>RTC8969</b>	Defender - up to 2A622423	Front	Rectangular	Pair
<b>STC53161</b>	Defender - 2A622424 onwards	Front	Rectangular - hinged	Pair
<b>RTC8860AA</b>	Defender - up to 2A	Rear	1 x Square & 1 x L-shape	Pair
<b>STC53157</b>	Defender - 2A onwards	Rear	1 x Square & 1 x L-shape	Pair
<b>DA4133</b>	Defender - Td5	Rear	Rectangular	Single
<b>DA4134</b>	Defender - Td5	Rear	Round	Single
<b>STC53158</b>	Defender - all models	Rear	Square - hinged	Pair
<b>VUB504110</b>	Defender - all models	Rear	Round	Pair
<b>STC8056LR</b>	Defender 110 - Hi-Capacity	Rear	Rectangular	Pair

Protect your **valuable lights** from accidental damage either on or off-road!

DA4349



DA2796



DA2796

These ABS plastic light guards will not rust and you don't need to drill your car to fit them - fitted in seconds.

<b>DA4349</b>	Defender - all models	Rear	Round - Fog, reversing light & NAS lights	Single
<b>DA2796</b>	Defender - all models	Rear	Round - Tail light & indicator	Single



RTC8969

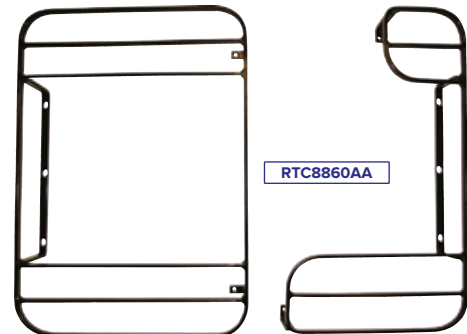

RTC8860AA

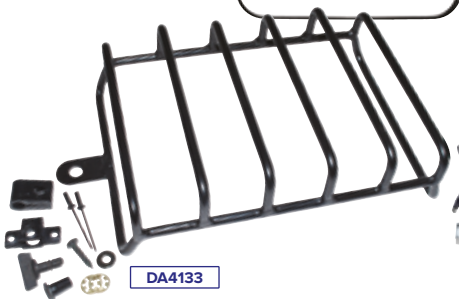

DA4133



DA4134



STC8056LR

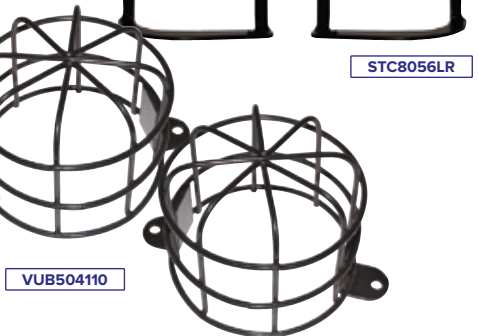

VUB504110



# EXTERIOR PROTECTION

## Light Guards

### Series

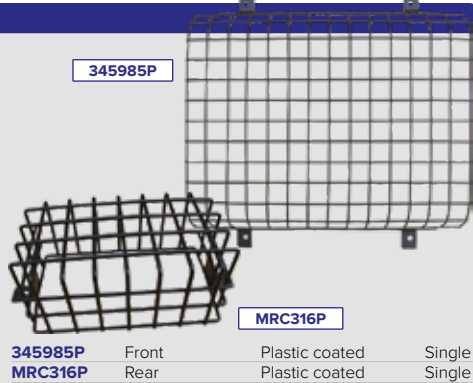
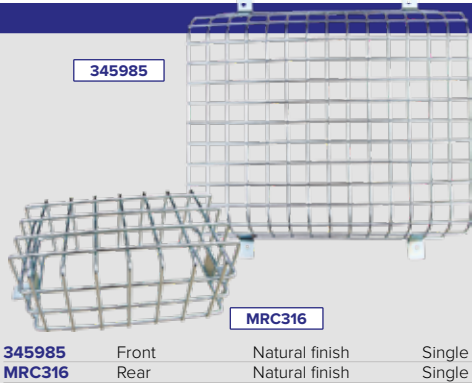

<b>345985</b> <b>MRC316</b>	Front Rear	Natural finish Natural finish	Single Single	<b>345985P</b> <b>MRC316P</b>	Front Rear	Plastic coated Plastic coated	Single Single
--------------------------------	---------------	----------------------------------	------------------	----------------------------------	---------------	----------------------------------	------------------

### Discovery



<b>RTC9503AA</b>	Discovery 1	Wing	Rear	<b>VUB501200</b>	Discovery 3 - all models	Front
<b>STC50026</b>	Discovery 2 - up to 3A		Front	<b>VUB501380</b>	Discovery 3 - all models	Rear
<b>STC50064</b>	Discovery 2 - 3A onwards	Acrylic headlight protectors	Front	<b>DA1286</b>	Discovery 3	Acrylic headlight protectors
<b>STC53193</b>	Discovery 2 - 3A onwards		Front	<b>Note</b> - All Discovery headlight guards supplied as pairs.		
<b>STC50027</b>	Discovery 2 - all models	Bumper & rear upper set	Rear			
<b>STC53194</b>	Discovery 2 - all models	Wing	Rear			
<b>VUB500520</b>	Discovery 2 - all models	Low	Rear			
	Not suitable for vehicles with parking sensors					



Range Rover



**DA1290** Range Rover Sport - 2005 - 2013 Front  
Acrylic headlight protectors  
**VUB501920** Range Rover Sport - 2005 - 2009 Rear  
**VPLTP0064** Range Rover Sport - 2010 - 2013 Rear  
**VUB001070LR** Range Rover L322 - up to 6A Front  
Not compatible with wraparound protection bar  
**DA1289** Range Rover Evoque Front  
Acrylic headlight protectors

**Note** - All Range Rover headlight guards supplied as pairs



Freelander



Protect your **valuable headlights** from accidental damage either on or off-road!

**VUB501390** Freelander 1 - 2004 onwards Front Pair  
**DA1287** Acrylic headlight protectors  
Freelander 2 Front Pair



Watch Car SOS's Fuzz Townshend explore Britpart...  
[www.britpart.com/sos](http://www.britpart.com/sos)



# EXTERIOR PROTECTION

## Mirrors

### XS Mirrors



DA6892



DA6893



DA6901

#### XS Wing Mirrors

Exclude mirror arms

DA6892 Black backing Single

DA6893 Silver backing Single

DA6900 Brunel backing Single

DA6901 Primer backing Single

### Blind Spot Mirrors

#### DA2907 NEW

Right hand side

#### DA2906 NEW

Left hand side

Mirror fits onto your existing wing mirror arm and with a wide angle convex mirror you'll improve your road safety by eliminating the dangerous blind spot when you change lanes. Wing mirror is 265 x 160mm - making it larger than a standard Defender mirror.



DA2907



Image for illustrative purpose only



### Heated Mirror Kit



#### DA4598

Heated mirror kit

See Enhancements section for more details.

### Unbreakable Mirrors

		Head Dimensions	Arm Length	
DA4404	Flat mirror	204 x 140mm (8 x 5½")	No arm	Flat with fixing kit
DA4405	Flat mirror	204 x 140mm (8 x 5½")	170mm	Flat with fixing kit and short arm
DA4406	Flat mirror	204 x 140mm (8 x 5½")	290mm	Flat with fixing kit and long arm
DA4407	Convex mirror	204 x 140mm (8 x 5½")	No arm	Convex with fixing kit
DA4408	Convex mirror	204 x 140mm (8 x 5½")	170mm	Convex with fixing kit and short arm
DA4409	Convex mirror	204 x 140mm (8 x 5½")	290mm	Convex with fixing kit and long arm

Good visibility is imperative on today's highways and byways

These high impact resistant mirror heads are an essential item

- > Optical quality polycarbonate lens - will not shatter like glass or discolour in sunlight
- > Strong, flexible polypropylene casing - will absorb hard blows without breaking
- > Universal - can be fitted to either left or right of vehicle
- > Lightweight - puts less strain on body fixings
- > Hard lacquer coating on lens - will repel condensation and surface water
- > Excellent reflectivity - superb daylight and night time vision

DA4406



### Standard Mirrors

#### Series

#### DA2128

Mirror arm 7" Standard

#### DA2130

Mirror head 7 x 5" Standard

#### DA2301

Mirror glass 7 x 5" Standard

DA2128



#### Defender

#### MTC5083

Mirror arm 7" Standard

#### RRC8443

Mirror arm 11½" Large

#### MTC5084

Mirror head 5 x 8" Standard

#### DA4034

Mirror head 6 x 10½" Large

#### MTC5217

Mirror assembly Standard

MTC5217



Photo by Peter Padfield



Defender - 1987 onwards			Note - RHS - Right hand side LHS - Left hand side	
LR055323	Front	90/110/130		RHS
LR055333	Front	90/110/130		LHS
RTC4685	Front	90/110/130 - flaps only		Pair
RTC9479	Front	90/110/130 - with brackets		Pair
LR055332	Rear	90 - black Britpart logo		RHS
LR055340	Rear	90 - with exhaust cut-out - black Britpart logo		LHS
CAT500450PMA	Rear	90 - no exhaust cut-out - black Britpart logo		LHS
DA4531	Rear	90 - with exhaust cut-out - yellow Britpart logo		Pair
DA4532	Rear	90 - no exhaust cut-out - yellow Britpart logo		Pair
DA4533	Rear	90 - wide mudflaps - universal fitment - no exhaust cut-out - yellow Britpart logo		Pair
MXC6412	Rear	90 - from FA414687 up to WA159806		RHS
MXC6413	Rear	90 - from FA414687 up to WA159806		LHS
MUC3990	Rear	90 - hard & soft top - from AA232011 up to FA414686		LHS
MUC2344	Rear	90 - from 3A650368 up to 5A690309		RHS
DA4534	Rear	110/130 Crew cab - yellow Britpart logo		Pair
DA4536	Rear	110/130 Crew cab - wide mudflaps - yellow Britpart logo		Pair
BTR277	Rear	110/130 - universal - flap only - from FA414616		Single
VPLDP0532 NEW	Rear	110/130 - universal - flap only - from FA414616		Pair
LR055330	Rear	110/130 - black Britpart logo		RHS
LR055334	Rear	110/130 - black Britpart logo		LHS
LR055331	Rear	110/130 HCPU - black Britpart logo		RHS
LR055339	Rear	110/130 HCPU		LHS
DA4535	Rear	110/130 HCPU - yellow Britpart logo		Pair

Defender - 2020 onwards				
VPLEP0387LR	Front	90 & 110 - classic mudflaps - larger & more flexible		Pair
VPLEP0389LR	Front	110		Pair
VPLEP0388LR	Rear	90 & 110 - classic mudflaps - larger & more flexible		Pair
VPLEP0390LR	Rear	110		Pair

Defender Mudflap Brackets - Photos available in Chassis & Body Section				
DA1188	Defender 90/110/130	Galvanised	Front	Pair
DA1187	Defender 90	Galvanised	Rear	Pair
DA2950 NEW	Defender 110/130	Galvanised	Rear	Pair
MTC3000SS	Defender 90/110/130	Stainless steel	Front	RHS
MTC3001SS	Defender 90/110/130	Stainless steel	Front	LHS
MUC3986SS	Defender 90	Stainless steel	Rear	RHS
MUC3987SS	Defender 90	Stainless steel	Rear	LHS

The two brackets below are not available as stand alone brackets from Land Rover - they are only available to order along with the mudflap. The universal number for the mudflap for all Defender 110/130 rear applications is BTR277/VPLDP532.

CAT500340PMASS	Defender 110/130	Stainless steel	Rear	RHS
CAT500350PMASS	Defender 110/130	Stainless steel	Rear	LHS

Can be used as a replacement bracket for - LR055331

Can be used as a replacement bracket for - LR055339

Discovery 1		
RTC6820	Front	Pair
RTC6821	Rear	Pair

Discovery 2		
CAS100900LR	Front & rear	RHS
CAS100910LR	Front & rear	LHS
STC50221	Front	RHS
STC50222	Front	LHS

Discovery 3		
CAS500010PCL	Front	Pair
CAT500010PCL	Rear	Pair
VPLAP0017 NEW	Rear	Pair
VPLAP0017 NEW	Partially painted bumper	

Discovery 4		
CAS500010PCL	Front	Pair
CAT500010PCL	Rear	Pair
VPLAP0017 NEW	Rear	Pair
VPLAP0017 NEW	Partially painted bumper	

Discovery 5		
VPLRP0283LR	Front	Pair
VPLRP0357LR	Rear	Pair

Discovery Sport		
VPLCP0277LR	Rear	Pair



Freelander 1			
STC7978ABL	Front	Up to 1A999999 - Hatton Grey	Pair
STC53075AALR	Front	From 2A000001 - Black	Pair
STC53076AALR	Rear	From 2A000001 up to 3A999999 - Black	Pair
CAT500060PMALR	Rear	From 4A000001 - Black	Pair

Freelander 2			
LR003324	Front		Pair
LR003322	Rear		Pair

Range Rover Classic			
RTC9562	Front	1986 - 1994	Pair
MXC5587	Front - flap only	1986 - 1994	Single
MXC5587	Rear - flap only	1986 - 1994	Single

Range Rover P38			
CAS100920	Front	From XA428522	RHS
CAS100930	Front	From XA428522	LHS
STC8535	Front		RHS
STC8536	Rear	Single exhaust	Pair
STC7703	Rear	Twin exhaust	Pair
CAT101160	Rear	From XA428522	RHS
CAT101170	Rear	From XA428522 - dual exhaust	LHS
CAT101180	Rear	From XA428522 - single exhaust	LHS

Range Rover Sport - 2005 - 2009			
CAS500070PCL	Front		Pair
CAT500120PCL	Rear	Less sport bumper protection	Pair

Range Rover Sport - 2010 - 2013			
CAS500070PCL	Front		Pair
VPLSP0016LR	Rear		Pair

Range Rover Sport - 2014 onwards - not SVR model			
VPLWP0167	Front	Compatible with electric deployable step	Pair
VPLWP0165	Front	Not compatible with electric deployable step	Pair
VPLWP0166	Rear		Pair

Range Rover L322 - 2002 - 2009			
CAS000150PMALR	Front	Up to 5A999999	Pair
VUB001320LR	Front	Up to 5A999999	RHS
VUB001330LR	Front	Up to 5A999999	LHS
CAS500060PMA	Front	From 6A198416	Pair
VUB503940	Front	From 6A198416 - for side step	Pair
CAT000180PMA	Rear	Up to 5A999999	Pair
CAT500070PMA	Rear	From 6A198416	Pair

Range Rover L322 - 2010 - 2012			
CAS500060PMA	Front	From AA000001	Pair
CAT500070PMA	Rear	From AA000001	Pair

Range Rover L405 - 2013 onwards			
VPLGP0111LR	Front	Compatible with electric deployable step	Pair
VPLGP0109	Front	Not compatible with electric deployable step	Pair
VPLGP0110	Rear		Pair

Range Rover Evoque			
VPLVP0065	Front	Pure & Prestige	Pair
VPLVP0069	Rear	Pure & Prestige	Pair
VPLVP0066	Front	Dynamic	Pair
VPLVP0070	Rear	Dynamic - excluding parallel parking sensors	Pair

More mudflap images at [www.britpart.com/mudflaps](http://www.britpart.com/mudflaps)

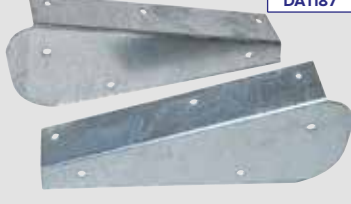



# EXTERIOR PROTECTION

## Rear Protection

### Bumpers & Bumperettes



DA5647

**Added protection...**



DA5646

#### DA5647

Discovery 1 - 300Tdi - will also fit 200Tdi. See note below.

- > One piece rear heavy-duty bumper manufactured from 5mm steel with incorporated steel end caps
- > Finished in black
- > Provision for NATO/recovery point in centre of bumper
- > Fixed to standard mounting points and for added strength, extra fixings in centre where tow bar mounts

**Note** - Tow bar and rear lights not included. Will fit 200Tdi if 300Tdi lights are used.

Right light - AMR6510; left light - AMR6509

#### DA5647KIT

Replacement fitting kit for heavy-duty bumper DA5647

#### DA5646

Discovery 2

- > One piece rear heavy-duty bumper manufactured from 4mm steel with incorporated steel end caps, finished in black
- > 2 Recovery points and 2 Hi-Lift jacking points included
- > Fixed to standard mounting points and for added strength, extra fixings in centre where tow bar mounts

**Note** - Tow bar and rear lights not included.

Up to 3A771194 - Right light - XFB101480 / Left light - XFB101490

From 3A771195 - Right light - XFB000720 / Left light - XFB000730

#### DA5646KIT

Replacement fitting kit for heavy-duty bumper DA5646

<b>DA2071</b>	Defender/Series	Rear bumperettes	Pair	Black
<b>DQN500040</b>	Defender 110 - Hi-Cap/Defender 130 - Hi-Cap	Rear stop bump	Single - RHS	Black
<b>DQN500050</b>	Defender 110 - Hi-Cap/Defender 130 - Hi-Cap	Rear stop bump	Single - LHS	Black
<b>RRC2970</b>	Defender/Series	Rear bumperette	Single - RHS	Black
<b>RRC2971</b>	Defender/Series	Rear bumperette	Single - LHS	Black
<b>ISG000040</b>	Defender Wolf	Rear bumperette	Single - RHS	Black
<b>ISG000050</b>	Defender Wolf	Rear bumperette	Single - LHS	Black

DA5647KIT

DA5646KIT



### Replacement Surround Cameras



#### LR052028LR

Front bumper  
Tailgate  
Side view mirrors  
Discovery 4  
Range Rover Evoque  
Range Rover Sport - 2014 onwards  
Range Rover L405



Photo by Ian Garner

### Parking Sensor Kit

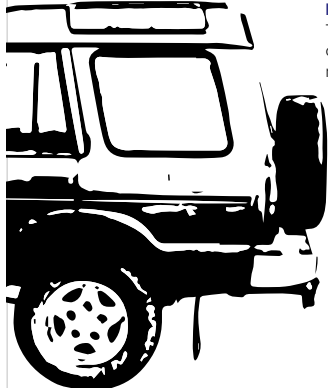

#### DA4511

These bumper\* mounted sensors will detect the distance between your vehicle and any rear obstruction and warn the driver to any potential obstructions. An advanced parking solution for obstacle detection at the rear of your vehicle. Reduce the risk of collision during reversing and reverse parking manoeuvres with this kit.

As the reverse gear is engaged, a sound indicates that the reverse sensors are activated. Any obstacle at the rear of the vehicle is then detected and signalled to the driver through a progressive sound whose frequency increases when moving closer to the obstacle. Enhance your safety through obstacle detection, even when objects are out of the driver's field of vision. Improve comfort through easy parking manoeuvres. Suitable for 12v cars, SUVs and light commercial vehicles.

- Kit contents include -
- 4 x Bumper fit sensors
  - 1 x Warning buzzer
  - 1 x Control unit
  - 1 x Wiring harness
  - 1 x Cutting tool
  - 1 x Fitting accessories
  - 1 x Installation instructions

**Add an extra set of 'eyes' when reversing...**



\*Note - Not suitable for vehicles with metal bumpers.



**Rock/Tree Sliders & Sill/Side Protectors**



**Rock Slider/Side Steps**

**DA7533** Black finish  
Discovery 3 & Discovery 4

The best of both worlds with these fitted to your Discovery!

**Rock Slider** - an essential purchase for any off road use. They prevent damage to the underside sill of the vehicle and allow for safe passage over rocky and rough terrain.

**Side Steps** - users often fit side steps to enable easy access to and from the car - this is a problem when going off-road as they bend, break and cause snagging. These heavy-duty side steps are made from 5mm steel plate with 50mm tube backed up by an additional 2 x 40mm tube supports. The joints are TIG welded for a smooth finish. Supplied as a pair.

**Rock Sliders**

**DA7534B** Black finish  
Discovery 3 & Discovery 4

These rock sliders (sill protectors) are manufactured from 6mm 5083 aluminium and come completely machined and drilled ready to fit. An essential purchase for any off-road use as they prevent damage to the underside sill of the vehicle and allow for safe passage over rocky and rough terrain. Attaches to your vehicle using 11 mounting points on the side and underneath and when the car doors are closed they are almost unseen, but you have the piece of mind that your car sills are safe from damage. These units require no additional drilling just unscrewing and unclipping of the plastic OEM parts.

For more information & images of these rock sliders visit [www.britpart.com/rock](http://www.britpart.com/rock)



*Direct fit!  
No Cutting!*

**DA1307**

**DA1308**

**DA1311**

**DA1313**

Great protection for the side of your Land Rover and they replace the sill of your vehicle. These rock & tree sliders are a fully welded 3mm steel construction with heavy-duty chassis mounted brackets and zinc primed with a smart black powder coated finish.

**Rock Sliders**

- DA1307** Defender 90 - 1983 onwards
- DA1308** Defender 110 - 1984 onwards
- DA1311** Discovery 1 - 3-door
- DA1313** Discovery 2

**Rock & Tree Sliders**

- DA1307T** Defender 90
- DA1308T** Defender 110
- DA1311T** Discovery 1 - 3-door
- DA1312T** Discovery 1 - 5-door
- DA1313T** Discovery 2

For more side protection - see side & rear step section



**DA1307T**

**DA1308T**

**DA1311T**

**DA1312T**

**DA1313T**



Photo by Jundio Salvador



# EXTERIOR PROTECTION

## Side Protection

### Rock/Tree Sliders & Sill/Side Protectors



#### Side Protectors

Add some protection with these side tubes - pairs

<b>DA7012</b>	Defender 90	Black with chequer plate top
<b>DA7011</b>	Defender 110	Black with chequer plate top

<b>DA7012SS</b>	Defender 90	Stainless steel
<b>DA7011SS</b>	Defender 110	Stainless steel



Photo by Robin Lewis

### Dirt D-fenders



Dirt D-Fenders are a great solution to the annoying problem of mud which splashes through the gap that exists between the bottom of the wheel arch and the mudflap of your Defender. They are an especially useful addition if you are using wider tyres. The Dirt D-Fenders attach with rivets into the underside of the sill and wheel arch flare. The smooth finish is suitable for painting to match your body colour. Supplied in pairs with fitting kit.

Defender		Textured Finish	Smooth Finish
90/110/130	Rear of front wheel	<b>DA1193</b>	<b>DA1193S</b>
90/110	Front of rear wheel	<b>DA1198</b>	<b>DA1198S</b>
90	Rear of rear wheel	<b>DA1197</b>	<b>DA1197S</b>
110	Rear of rear wheel	<b>DA1194</b>	<b>DA1194S</b>

**Note** - DA1193(S) & DA1198(S) will not fit Defenders with rock/tree sliders fitted.



**DA1194S**

### Wheel Arch Kits - Plus 30mm Kits



#### Defender Plus 30mm Wheel Arch Kits

<b>DA1979</b>	Front pair
<b>DA1978</b>	Rear pair

Designed to keep your vehicles legal when fitting wider tyre and wheel combinations whilst maintaining an appearance closer to the standard arch than other wide arches. Using similar material to the OE arches they fix to the vehicle using the normal style clips - supplied.



**DA1979**

**Note** - Wheel arches shown here with 285 75/R16 tyres on a ZU rim with an 11mm + VE offset

*Keep your vehicles legal when fitting wider tyre and wheel combination.*



**Wheel Arch Kits - Standard**



DA1059



DA1140



VPLEP0379LR

Replace any faded or damaged wheel arches with these OEM replacement wheel arch kits. Full kit for each vehicle.

**DA1059** Defender - all models

**DA1140 NEW** Discovery 2

**VPLEP0379LR** Defender 110 - 2020 onwards  
Wheel arch protection - Anthracite coloured high-quality, durable plastic kit. Set of 4.

**Wheel Arch Kits - Off-Road**



DA2364

DA2365

DA1960

**Discovery 2**

These wheel arches enable larger tyres to be fitted while still being legal as these arches cover the tyres when wider tyres are fitted. They are virtually indestructible and all fixings are supplied with the kit.

**DA1960** Discovery 2 50mm  
50mm arches are required for large off-set wheel. Up to 31" diameter tyres with a 2" lift. Wing does not need cutting for fitment.

**DA1961** Discovery 2 75mm  
75mm arches will cover the tyres when wheel spacers are used. Up to 35" diameter tyres with a 2" lift. Wing does need cutting for fitment.

**Discovery 1 & Range Rover Classic**

2½" wheel arch kits  
Wings need cutting for fitting  
Full kit

**DA2364**

Discovery 1

Range Rover Classic - 3-door

**DA2365**

Discovery 1

Range Rover Classic - 5-door

**Defender**

2" wider than standard enabling tyres up to 14" wide and/or wheel spacers to be fitted while being legal for MOT testing. Made from an unbreakable plastic - ideal for extreme off-road use. Full kit.

**DA2366**

Defender 90/110 - 1984 onwards



DA2366

DA1960

DA1961

DA1961

**Outdoor & Indoor Covers**

**Ultimate Outdoor Covers**

The Ultimate Outdoor Car Covers are made from a specially formulated advanced nanotechnology fabric, giving a unique water resistant coating to ensure long term protection and care for your Land Rover. The cover is manufactured from an advanced fabric which is fully waterproof\*, fully breathable, strong and stretchy. The fabric is a little like a wetsuit, making them extremely soft on the inside and extremely durable. The covers have three sets of fully detachable straps underneath to help secure the cover, one at each end and one in the middle.

\*Whilst the fabric is waterproof occasionally some seepage may occur through the seams, this will evaporate naturally as the fabric is breathable.

**Note** - At certain times of year (particularly in winter) when the air temperature fluctuates often, you will find that any outdoor car cover won't stop condensation forming on the car. The cold bodywork of the car will attract condensation due to the warm micro-climate within the car cover, however these covers are fully breathable, so as the temperature equalises this will evaporate through the cover. If you are worried about condensation forming during this higher humidity weather, we advise removing the car cover for a short while to let both the cover and the car air.

**DA2834**

Series 1 - 86" & 88"/Series 2 - 88"

Series 2A - 88"/Series 3 - 88"/Defender 90

**DA2835**

Defender 110/Discovery 1, 2, 3, 4 & 5  
Range Rover/Range Rover Sport

**Super Soft Stretch Indoor Covers**

This super soft, super stretchy indoor car cover is made with Lycra blended, satin fabric which allows the cover to cling to the car whilst its subtle sheen gives an elegant finish. Tightly knitted fleece lined fabric provides excellent protection from dust and other pollutants as well as remaining breathable to prevent any build-up of condensation forming on the car. The snug fit of these covers ensures that they not only look great but also provide exceptional protection. Low profile seams guarantee a sleek finish whilst displaying the contours and profile of your Land Rover.

**DA2837**

Series 1 - 86" & 88"/Series 2 - 88"/Series 2A - 88"/Series 3 - 88"/Defender 90

**DA2836**

Defender 110/Discovery 1, 2, 3, 4 & 5/Range-Rover/Range Rover Sport/Range Rover Velar



DA2834

*Advanced fabric - fully waterproof*



DA2836

*Tightly knitted fleece lined fabric*



# EXTERIOR PROTECTION

## Underside Protection

### Fuel Tank, Steering/Sump & Transmission Guards



#### Sump Guards

These guards from Britpart are manufactured from high-quality, hard-wearing and corrosion resistant materials to counteract any unforeseen obstacles your Land Rover may encounter whilst off-roading. All fixings are supplied and the guards fit into the vehicle's pre-existing holes. Each guard has holes at the front to allow for water drainage and also to help with ventilation for the cooling system.

<b>DA5507</b>	Defender - 1985 -2006 & 2007 onwards Main plate - 8mm thick; brackets - 8mm thick	Aluminium	RHD
<b>DA5507LHD</b>	Defender - 1985 -2006 & 2007 onwards Main plate - 8mm thick; brackets - 8mm thick	Aluminium	LHD
<b>DA5507KIT</b>	Spare fitting kit for DA5507 & DA5507LHD - nuts, bolts & washers		
<b>VPLEP0436LR</b>	Defender 2020 - 90 & 110	Aluminium	
Robust, 5mm anodised aluminium. Protects lower bumper area and radiator when driving off-road. The undershield is also reinforced by the mounting assembly which enhances the protection. Allows easy access to the recovery loop which facilitates recovery of the vehicle if grounded.			
<b>DA5508</b>	Discovery 1/Range Rover Classic Main plate - 8mm thick; brackets - 8mm thick	Aluminium	RHD & LHD
<b>DA2249</b>	Discovery 2 Main plate - 5mm thick; brackets - 5mm thick. Note - For use with Discovery 2 winch bumper DA5645	Powered coated steel	RHD & LHD
An essential purchase for any off road use as they prevent damage to the underside of the engine and the intercooler at the front of the vehicle. Manufactured from 8mm 5083 aluminium with a smart silver or black finish and supplied completely machined and drilled ready to bolt directly to the 4 pre-drilled holes in the chassis with supplied galvanised fixings. The guard requires no additional drilling just unscrewing and unclipping of the plastic OEM parts. Fitting should take 5 minutes.			
<b>DA7530</b>	Discovery 3	Silver finish	
<b>DA7530B</b>	Discovery 3	Black finish	
<b>DA7535</b>	Discovery 4	Silver finish	
<b>DA7535B</b>	Discovery 4	Black finish	

## Great **Protection** from Hidden **Dangers!**

#### Sump Plate

**DA7536** Discovery 3  
This sump plate protects the underside of the engine and allows the car to slide over objects, forward and backwards due to the rear lip. With a natural finish the plate is made from 6mm 5083 grade aluminium and has been water jet cut to a precise finish. Plate bolts directly into existing holes and bulkheads already in the chassis, using the standard Land Rover fixings.

#### Transmission Guards

**DA5625** Defender - Td5  
Reduce damage to your Defender 90. Made from galvanised steel, this transmission guard protects your 90's gear box and cross members from snagging and reduces damage to your vehicle. Bolts on and is easy to fit and importantly it is also easy to remove when your vehicle needs servicing. **Note** - Only fits with centre exhaust removed and pipe fitted.

**DA7532** Discovery 3  
This transmission plate protects the underside of the transmission and allows the car to slide over objects. With a natural finish the plate is made from 6mm 5083 grade aluminium and water jet cut to a precise finish. Plate bolts directly into existing holes and bulkheads already in the chassis, using the standard Land Rover fixings and two additional fixings.  
**Note** - Can only be fitted when sump plate (DA7536) is also fitted.

#### Fuel Tank Guards

Protect your Defender's fuel tank. Manufactured from 6mm aluminium.

**DA6538** Defender 90 - Td5 & 2007 onwards  
**DA6539** Defender 110 - Td5 & 2007 onwards



### Fuel Cooler Guard



**DA6540**  
Defender - Tdci  
Protect the Defender's vulnerable fuel cooler with this easy to fit electro-plated guard.



### Swivel Housing Gaiter Kits



**DA3057**

- > Bond in place under existing flange
- > Completely seals against dust, water and grit
- > Moulded in high performance neoprene rubber
- > No special tools required
- > Proven tongue and groove for easy assembly
- > Kit includes two gaiters, metal straps, bonding agent, gloves and full instructions

**DA3056** Series/Lightweight **Permanent Protection!**

**DA3057** Defender/Discovery 1/Range Rover Classic

**DA3057GLUE**  
Additional bonding agent for DA3056 & DA3057  
For easier fitting of gaiter without dismantling the axle assembly.

### Universal Joint Silicone Sleeves



Suitable for Series, Defender, Discovery 1, Discovery 2 & Range Rover Classic. By adding one of these silicone sleeves you will reduce debris from building up in the universal joint which, in time, will increase the life span of the joint.

**DA4810**  
Rear UJ silicone sleeve for 63mm diameter propshafts  
**DA4811**  
Rear UJ silicone sleeve for 51mm diameter propshafts



### Diff Guards



**DA2250B**

**DA2250GALV**

Defender/Discovery 1/Range Rover Classic  
Give your vehicle some extra protection with a diff guard. This guard is simple to fit (no drilling) and has the added advantage of having the fill plug accessible at all times.

**DA2250B** Electroplate finish  
**DA2250GALV** Galvanised finish

### Outrigger Mud Shields

**DA3477 NEW**

**Front Outrigger Mud Shields**

Defender

These Gwyn Lewis 4x4 outrigger mud shield guards will fit all Defenders. Designed to stop all the mud and road salt getting on top of the front outriggers which can cause them to rot away, even galvanized chassis can suffer after a while. They also make cleaning your Defender much easier as the mud can't get into the outrigger and around the footwell. Another advantage of fitting them is they also cut down road noise especially in wet conditions. Manufactured from a rigid but still flexible 3mm plastic material in black, they are very easy to fit. Just slide them in behind the inner wing and use the 2 inner wing securing screws (included) to secure them. Fitting instructions are supplied with the kit.

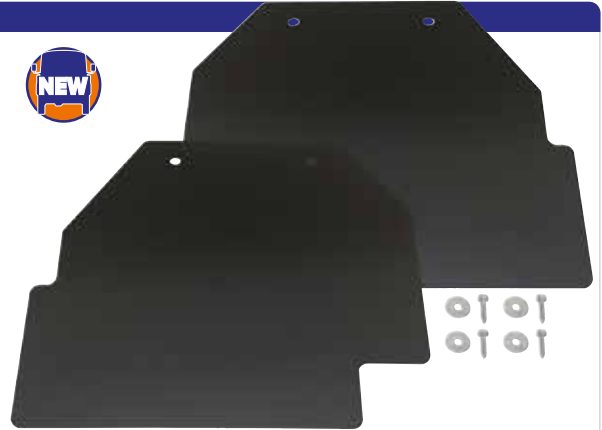

### Window Guard Kits

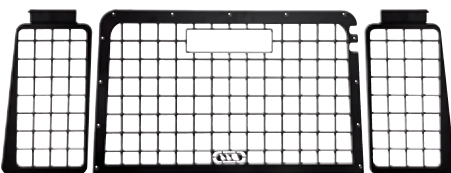

**DA1586**  
**Internal Rear Window Guards**

Defender 90 - 2002 onwards  
Defender 110 - 2002 onwards  
3 guard set  
Window guards for the small quarter windows at the rear of the vehicle and the tailgate door offering protection to the glass.

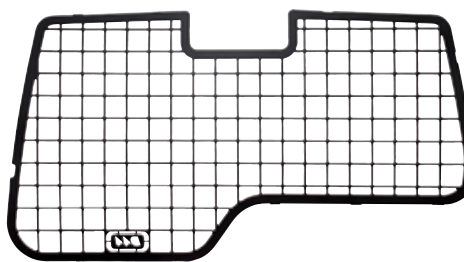

**DA1588**  
**Internal Tailgate Rear Door Window Guard**

Discovery 2  
Window guard for the tailgate door offering protection to the glass.



**DA1587**  
**External Window Guards**

Defender 90 - 2002 onwards  
Defender 110 - 2002 onwards  
5 guard set  
Externally mounted window guards for the side windows, small quarter windows at the rear of the vehicle and an internal guard for the tailgate door offering full protection to the glass.

These guards will increase security by deterring opportunists looking to enter from the rear, less visible part of your Land Rover. Designed to fit perfectly and providing full window coverage for the vehicle, these grills are constructed from 2mm steel with a zinc and black powder coat. All guards are supplied with the necessary brackets & fixings required for fitting at home.





# EXTERIOR PROTECTION

## Wind Deflectors



DA6078



DA2937



DA6675



DA6676



DA6070



DA6071



DA1514



DA6072



DA6079

<b>DA6078</b>	Defender/Series	Front	2 piece kit	<b>DA6071</b>	Discovery 2	Front & rear	4 piece kit
<b>DA2937 NEW</b>	Defender/Series	Rear	2 piece kit	<b>DA6072</b>	Discovery 3/Discovery 4	Front & rear	4 piece kit
<b>DA6675 NEW</b>	Defender 90 - 2020	Front	2 piece kit	<b>DA1514</b>	Discovery 5	Front & rear	4 piece kit
<b>DA6676 NEW</b>	Defender 110 - 2020	Front & rear	4 piece kit	<b>DA6079</b>	Discovery Sport	Front & rear	4 piece kit
<b>DA6070</b>	Discovery 1	Front & rear	4 piece kit				



Photo by Jan de Keijzer





The Britpart wind deflectors will reduce buffeting and wind noise when driving with the window open. Custom designed for each vehicle and easily attached - no drilling required for fitting!

**No drilling  
required  
for fitting!**

<b>DA6073</b>	Freelander 1 - 2 door	Front	2 piece kit	<b>DA1513</b>	Range Rover Velar	Front & rear	4 piece kit
<b>DA6077</b>	Freelander 1	Front & rear	4 piece kit	<b>DA6075</b>	Range Rover L322	Front & rear	4 piece kit
<b>DA6074</b>	Freelander 2	Front & rear	4 piece kit	<b>DA6108</b>	Range Rover L405	Front & rear	4 piece kit
<b>DA6070</b>	Range Rover Classic	Front & rear	4 piece kit	<b>DA6093</b>	Range Rover Evoque - 3 door	Front	2 piece kit
<b>DA6121</b>	Range Rover P38	Front & rear	4 piece kit	<b>DA6094</b>	Range Rover Evoque - 5 door	Front & rear	4 piece kit
<b>DA6076</b>	Range Rover Sport - 2005 - 2013	Front & rear	4 piece kit	<b>DA6677 NEW</b>	Range Rover Evoque - 2019 onwards	Front & rear	4 piece kit
<b>DA6107</b>	Range Rover Sport - 2014 onwards	Front & rear	4 piece kit				







Photo by Jane Boreham



# SIDE & REAR STEPS

*Step Into Your Landy With Ease*



# SIDE & REAR STEPS

## Defender

### Side Protectors



<b>DA7012</b>	Defender 90	Black with chequer plate top	Pair
<b>DA7011</b>	Defender 110	Black with chequer plate top	Pair
<b>DA7012SS</b>	Defender 90	Stainless steel	Pair
<b>DA7011SS</b>	Defender 110	Stainless steel	Pair
<b>VPLEP0433LR</b>	Defender 2020 - 90		Pair
Side protection tubes - aluminium - not compatible with fixed side step			
<b>VPLEP0434LR</b>	Defender 2020 - 110		Pair
Side protection tubes - aluminium - not compatible with fixed side step			



### Side Steps

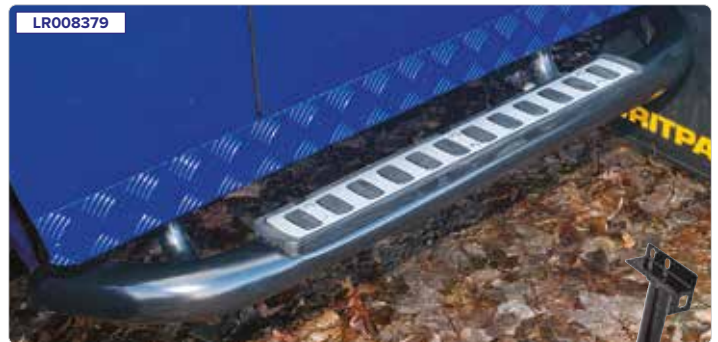

<b>LR008379</b>	Defender 90 - 2003 ->/Defender 110 - 2-door pick-up - 2003 ->	Pair
<b>LR008375</b>	Defender 110 - 2003 -> - not 2-door pick-up	
<b>LR008379B</b>	Defender 90 - 2003 ->/Defender 110 - 2-door pick-up - 2003 ->	Pair
<b>LR008375B</b>	Defender 110 - 2003 -> - not 2-door pick-up	
<b>LR008379SS</b>	Defender 90 - 2003 ->/Defender 110 - 2-door pick-up - 2003 ->	Pair
<b>LR008375SS</b>	Defender 110 - 2003 -> - not 2-door pick-up	
<b>LR029294KIT</b>	Defender 90 - 2003 ->/Defender 110 - 2-door Pick-up - 2003 ->	Pair
<b>LR029295/7KIT</b>	Defender 110 - 2003 -> - not 2-door pick-up	

### Rock Sliders

See **Exterior Protection** section for a wide range of rock slider protection



<b>DA4101</b>	Defender 90	Black with rubber top	Pair
<b>DA4060</b>	Defender 110	Black with rubber top	Pair
<b>VPLDP0068</b>	Defender 90	Twin tube - black with rubber top	Pair
<b>VPLDP0067</b>	Defender 110	Twin tube - black with rubber top	Pair
<b>DA2900</b>	Replacement end caps for VPLDP0068 & VPLDP0067		Set of 8



**Side Steps**

- STC7631** Up to 2007 Single
- LR020614** 2007 onwards Single
- Folding side step with rubber top
- STC7631MT** Up to 2007 Single
- LR020614MT** 2007 onwards Single
- Folding side step with rubber tyre tread top
- DA4814** Replacement rubber top with tyre tread pattern for STC7631MT & LR020614MT



DA4814



STC7631MT / LR020614MT

STC7631 / LR020614

**Rear Steps**



STC50301



STC50269AA

BUMPER SHOWN WITH MODIFIED DROP PLATE

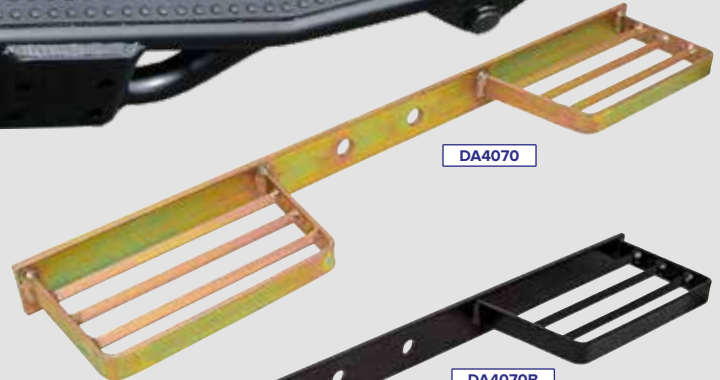

DA4070

DA4070B

- STC50269AA** Defender 90 - XA onwards  
NAS style rear step - includes regulation tow bracket  
Excludes drop plate, electric components and tow ball
- STC50301** Defender 110 - XA onwards  
NAS style rear step - includes regulation tow bracket  
Excludes drop plate, electric components and tow ball
- STC50269AAB**  
Replacement bung for STC50269AA for STC50301
- DA4070** All models  
Rear tow ball step - double with zinc plated finish  
Will also fit any vehicle with a drop plate tow hitch
- DA4070B** All models  
Rear tow ball step - double with black  
Will also fit any vehicle with a drop plate tow hitch
- STC7632** Up to 2007
- LR016430** 2007 onwards  
Folding rear door step with rubber top
- STC7632MT** Up to 2007
- LR016430MT** 2007 onwards  
Folding rear door step with rubber tyre tread top
- DA4818** Replacement rubber top with tyre tread pattern for STC7632MT & LR016430MT

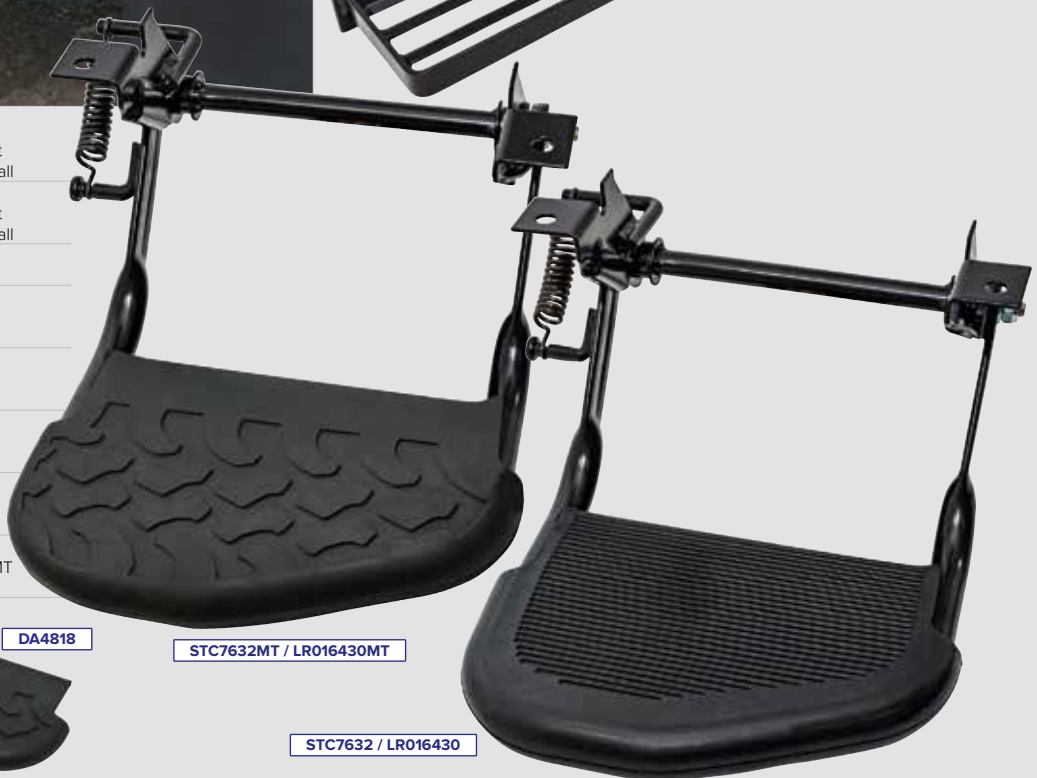

STC7632MT / LR016430MT

STC7632 / LR016430



DA4818

STC50269AAB



# SIDE & REAR STEPS

## Discovery

### Side Steps



VTD500010



VPLRP0347LR



VPLRP0270LR



VPLCP0210LR

<b>Discovery 1</b>			
<b>STC8130AB</b>	Side steps	Chevron tread	Pair
<b>Discovery 2</b>			
<b>DA8534</b>	Side steps - including mudflaps	Chevron tread	Pair
Replacement mudflaps -	<b>STC50221</b> - RHS & <b>STC50222</b> - LHS		
<b>STC50032</b>	Side steps - including mudflaps	Stainless steel	Pair
<b>Discovery 3/Discovery 4</b>			
<b>VTD500010</b>	Black steel side protection tubes		Pair
<b>VTD500020</b>	Stainless steel side protection tubes		Pair
<b>VPLAP0035</b>	Side steps - with polypropylene side step top and a brushed aluminium side trim		Pair

<b>Discovery 5</b>			
<b>VPLRP0347LR</b>	Side steps		Pair
<b>VPLRP0270LR</b>	Side tubes		Pair
<b>Discovery Sport</b>			
<b>VPLCP0210LR</b>	Side steps		Pair
<b>VPLCP0209</b>	Side tubes		Pair



Photo by Pete Bell



**Side Steps**



See them in action at [www.britpart.com/DA1512](http://www.britpart.com/DA1512)



**DA1512**

**Electric Deployable Side Steps**

Discovery 4

- > Easy access to your Discovery 4
- > Never available from Land Rover as an OE option
- > Smart design. Enhance the look of your Discovery 4
- > Tucked away when driving, prevents damage. Fixed steps are susceptible to damage when driving off-road
- > Side steps automatically lower into place when a door is open and raise once door is shut
- > Safety cut-off should step encounter an object
- > Function to lower step with door shut - ideal for accessing the roof
- > Manufactured from aluminium - strong and light



Photo by Ian Jameson

**Rock Slider/Side Step**



**DA7533**

Discovery 3/Discovery 4  
Pair

**Rock Slider** - an essential purchase for any off-road use. They prevent damage to the underside sill of the vehicle and allow for safe passage over rocky and rough terrain.

**Side Step** - users often fit side steps to enable easy access to and from the vehicle - this is a problem when going off road as they bend, break and cause snagging. These are heavy-duty side steps made from 5mm steel plate with 50mm tube backed up by an additional 2 x 40mm tube supports. The joints are TiG welded for a smooth OEM finish. The other benefit of this rock slider/side step combo is that the outer 'bar' pushes away small trees and scrub from the bodywork of the vehicle. They can also be used to 'slide' around thick trees when grip is minimal. These units require no additional drilling just unscrewing and unclipping of the plastic OEM parts. Fitting should take 15 minutes each side. Grip tape supplied loose for optional fitment.

*The best of both worlds with these fitted to your Discovery!*

**Freelander**

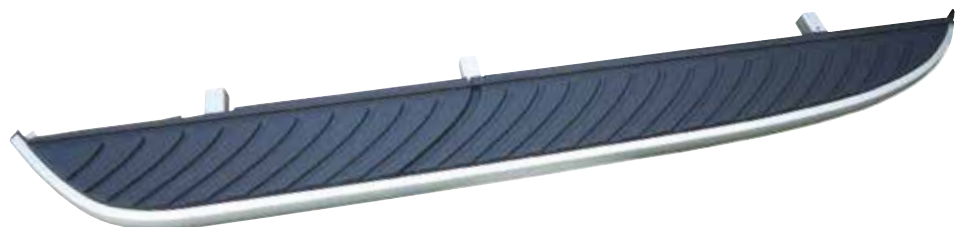

**LR002773**

Freelander 2 Side steps Pair  
With thermo plastic elastomer side step top and a brushed aluminium side trim



# SIDE & REAR STEPS

## Range Rover



<b>Range Rover Classic</b>			
<b>STC8130AB</b>	Side steps - black rubber		Pair
<b>Range Rover P38</b>			
<b>STC8505AA</b>	Side steps - includes mudflaps		Pair
<b>Range Rover Sport - 2005 - 2013</b>			
<b>VPLSP0040</b>	Side steps		Pair
With thermo plastic elastomer side step top and a brushed aluminium side trim			
<b>Range Rover Sport - 2014 onwards</b>			
<b>VPLGP0226</b>	Side steps		Pair
<b>VPLGP0367LR</b>	Powered side step - step	Left hand side	Single
<b>VPLGP0248LR</b>	Powered side step - fixings	Left hand side	Single
<b>VPLGP0366LR</b>	Powered side step - step	Right hand side	Single
<b>VPLGP0249LR</b>	Powered side step - fixings	Right hand side	Single
<b>Range Rover L322</b>			
<b>VUB001230</b>	Stainless steel side protection tubes		Pair
<b>VUB503660</b>	Side steps		Pair
Including front mudflaps with EPDM (synthetic rubber) top and hard plastic trimming			
<b>VUB001300</b>	Side step replacement insert moulding for VUB503660	Right hand side	
<b>VUB001310</b>	Side step replacement insert moulding for VUB503660	Left hand side	
<b>Range Rover L405</b>			
<b>VPLGP0226</b>	Side steps		Pair
<b>VPLGP0367LR</b>	Powered side step - step	Left hand side	Single
<b>VPLGP0248LR</b>	Powered side step - fixings	Left hand side	Single
<b>VPLGP0366LR</b>	Powered side step - step	Right hand side	Single
<b>VPLGP0249LR</b>	Powered side step - fixings	Right hand side	Single
<b>Range Rover Evoque</b>			
<b>VPLVP0184</b>	Stainless steel side protection tubes - up to 2019 only		Pair



Photo by Rachel Travers



# RACKS & ROLL CAGES



We've Got Carrying  
More Covered



# RACKS & ROLL CAGES

## Roof Racks

### Britpart Expedition Roof Racks



DA3072



DA3072



DA3070



DA6529



DA6629



These roof racks are manufactured from aluminium with a smart black powder coated finish. Fully welded, they are extremely strong, versatile, with a low profile and are easy to use. The floor plank profiles are orientated longitudinally which results in a reduction in wind noise. There are nut channels on all the extrusions to allow for easy fitment of 3rd party accessories.

**DA3072**  
Defender 90 3 feet per side  
Weight - 32kg  
Dimensions - 2,050 L x 1,500mm W  
Vehicle gutter to top of rack - 265mm

**DA3070**  
Defender 110 4 feet per side  
Weight - 38kg  
Dimensions - 2,750 L x 1,500mm W  
Vehicle gutter to top of rack - 265mm

**DA3269**  
Defender 110 Double cab pickup 3 feet per side  
Defender 130 Double cab pickup  
Weight - 27kg  
Dimensions - 1,600 L x 1,500mm W  
Vehicle gutter to top of rack - 265mm

**DA2901**  
Defender 2020 - 110 4 feet per side  
Weight - 22kg  
Dimensions - 2,100 L x 1,260mm W  
Vehicle gutter to top of rack - 110mm

**DA6529**  
Discovery 1 & Discovery 2 3 feet per side  
Weight - 26kg  
Dimensions - 2,050 L x 1,500mm W  
Vehicle gutter to top of rack - 265mm  
**Note** - Will only fit vehicles without factory fitted roof rails.

**DA6629**  
Discovery 1 & Discovery 2 3 feet per side  
Weight - 27kg  
Dimensions - 2,050 L x 1,500mm W  
Vehicle gutter to top of rack - 340mm

**DA6537**  
Discovery 3 & Discovery 4 4 feet per side  
Weight - 23kg  
Dimensions - 2,300 L x 1,260mm W  
Roof to top of rack - 120mm  
**Note** - May need roof rail kit (CAB500120PVJ or CAP500090) to be fitted to vehicle prior to roof rack installation.



DA6529



DA6629



DA6537



DA6537

More images online at [www.britpart.com/expedition](http://www.britpart.com/expedition)



DA2901



DA2901



More images and video at [www.britpart.com/DA2901](http://www.britpart.com/DA2901)



### Galvanised Roof Racks

#### FLAT FLOOR ROOF RACK



#### CONTOUR FLOOR ROOF RACK



#### Short Wheel Base Flat Packed Galvanised Roof Racks

Length - 1,990mm (78½")  
 Height - 420mm (16½")  
 Width - 1,460mm (57½")  
 Weight - 25kg Weight - 30.5kg  
**DA1091** Defender 90/Series SWB Contour floor

#### Long Wheel Base Flat Packed Galvanised Roof Racks

Length - 2,800mm (110½")  
 Height - 420mm (16½")  
 Width - 1,460mm (57½")  
 Weight - 25kg Weight - 30.5kg  
**DA1090** Defender 110/Series LWB Flat floor  
**DA1092** Defender 110/Series LWB Contour floor

Contour racks must not be used on vehicles fitted with a sunroof.

**DA1089** Ladder - galvanised - non-drill type

**Note** - Please check as DA1089 partially covers the number plate and may not comply with your country's MOT regulations.



### Roof Bar



Can be used as a spotlight mounting bar!

#### DA5570

Roof bar - single  
 Defender 90 & 110 - 1991 onwards  
 Weight 4kg  
 Load 100kg

### Summit Roof Bars

- DA5350 NEW** Discovery 5 - with rails
- DA5351 NEW** Discovery Sport - with rails
- DA5352 NEW** Range Rover Evoque - 2011 - 2018 with rails

Summit aluminium roof bars complete with pre-mounted feet and ready to use on vehicles with raised railings.

- > Aluminium roof bars with non-slip coating
- > Fully assembled ready to use
- > Plastic foot suitable for open railings
- > Fixing system with allen key which fixes the bar to the foot and the foot to the railing at the same time
- > T-Track width on aluminium roof bars - 20mm
- > Locks included
- > Three year guarantee
- > Manufactured to TUV standards
- > Maximum load 75kg



**DA5353 NEW** Range Rover P38 - fixed point and standard roof  
 Summit premium multi-fit roof bars are the modular system designed to meet all demands for loading goods on the roof with the utmost care for quality, design and safety.

- > Steel roof bars with non-slip coating
- > Roof bar profile - 30mm x 20mm
- > Fully assembled ready to use
- > Three year guarantee
- > Manufactured to TUV standards
- > Maximum load 75kg



### Front Runner Roof Racks

#### DA3077



All aluminium construction, fully welded. Powder coated finish. Patented slat, with grooves to accommodate 8mm bolts. Modular design - allow accessories to be mounted and removed as need without drilling. Rail towards the rear, open in the front. Gutter mount stainless steel clamps

Full Racks - Silver

**DA3077** Freelander 1

**DA3086** Freelander 1 - original mountings

### Land Rover Roof Racks

#### Roof Bars/Rails

- VPLER0177LR** Defender 2020 - 110 - Roof rails
- Facilitate fitment of cross bars which enable a range of roof carrying accessories to be fitted
- VPLER0178LR** Defender 2020 - 110 - Roof rack cross rails
- STC8057ACL** Discovery 2 Sports
- VPLAR0001 NEW** Discovery 3/Discovery 4
- LR002417LR** Freelander 2

#### Roof Racks - Expedition

- CAB500130PMALR** Range Rover Sport - 2005 - 2013
- CAB500070PMALR** Range Rover L322
- VPLER0181LR** Defender 2020 - 110
- Low line, lightweight & fully integrated design - more info online

#### Ski Carrier - use in conjunction with roof cross bars

- VPLZR0187LR** Defender - 2020/Discovery Sport/Discovery 5
- Range Rover Evoque - 2019/Range Rover Velar
- Range Rover Sport - Mk2/Range Rover L405

#### VPLER0181LR



#### VPLAR0001



For images please visit [www.britpart.com/racks](http://www.britpart.com/racks)





# RACKS & ROLL CAGES

## Roof Racks

### Safety Devices Roof Racks - Explorer Range



#### Safety Devices Explorer Roof Rack Range Heavy-duty Steel Roof Rack

Explorer roof racks can be affixed with a system of detachable roof cross rails to the rainwater gutters or with aluminium clamps to fit directly on to the majority of Safety Devices' external roll cages. A rain gutter mounted roof rack can be converted into a roll cage mounted roof rack with the appropriate fitting kit. The standard pack includes a steel roof rack, fixing bolts and optional roof cross rails.

Roof racks are grit blasted, primed with a zinc enriched powder undercoat, and finished with a durable black powder coat. Tents can normally be affixed to the roof rack without a floor, although a marine ply non-slip floor is also available.

Additional roof cross rails are available to purchase for use without a roof rack for use as, for example, a roof bar, basic tent support, attaching a roof storage box or to spread additional load on the Safety Devices' roof racks.

**Note** - Not compatible with a sunroof.



#### Notes

**Short Luggage Rail** with rain gutter mount, ideal for side loaded tents.

**Long Luggage Rail** with rain gutter mount, ideal for front or back loaded tents.

**Defender 90 Hard Top & Station Wagon - Full Length Rack**

**Defender 110 Hard Top & Station Wagon - Three Quarters Length Rack**

<b>DA4702</b>	Short luggage rail	Gutter mount*	2.0m x 1.4m	32kg
<b>DA4712</b>	Short luggage rail	Roll cage mount	2.0m x 1.4m	30kg
<b>DA4703</b>	Long luggage rail	Gutter mount*	2.0m x 1.4m	32kg
<b>DA4713</b>	Long luggage rail	Roll cage mount	2.0m x 1.4m	30kg
<b>DA4724</b>	Full luggage rail	Gutter mount*	2.0m x 1.4m	50kg
<b>DA4723</b>	Full luggage rail	Roll cage mount	2.0m x 1.4m	45kg
<b>DA4704</b>	Marine ply floor		2.0m x 1.4m	16kg

Refer to owners handbook for recommended maximum weight.

\*3 roof cross rails as standard and can accommodate 2 additional roof cross rails.



#### Additional Roof Cross Rails

<b>DA4711</b>	Gutter mount	4kg
<b>DA4717</b>	Roll cage mount	4kg

#### Roof Ladders

Mounts to rain gutter & cross-member.  
For use with both gutter and roll cage mounts.

<b>DA4710</b>	Left hand side	6.5kg
<b>DA3285 NEW</b>	Right hand side	6.5kg

## **Safety Devices®**

For more Safety Devices roof rack images  
[www.britpart.com/safety-devices-racks](http://www.britpart.com/safety-devices-racks)

#### Defender 110 Hard Top & Station Wagon - Full Length Rack

<b>DA4705</b>	Short luggage rail	Gutter mount*	2.8m x 1.4m	42kg
<b>DA4714</b>	Short luggage rail	Roll cage mount	2.8m x 1.4m	40kg
<b>DA4706</b>	Long luggage rail	Gutter mount*	2.8m x 1.4m	42kg
<b>DA4715</b>	Long luggage rail	Roll cage mount	2.8m x 1.4m	40kg
<b>DA4725</b>	Full luggage rail	Gutter mount*	2.8m x 1.4m	55kg
<b>DA4716</b>	Full luggage rail	Roll cage mount	2.8m x 1.4m	50kg
<b>DA4707</b>	Marine ply floor		2.8m x 1.4m	23kg

Refer to owners handbook for recommended maximum weight.

\*4 roof cross rails as standard and can accommodate 3 additional roof cross rails.

#### Defender 90 Station Wagon & Hard Top

##### Defender 110 & 130 Double Cab/Crew Cab Pick-Up

<b>DA4708</b>	Short luggage rail	Gutter mount*	1.6m x 1.4m	26kg
<b>DA4738</b>	Long luggage rail	Roll cage mount	1.6m x 1.4m	23kg
<b>DA4734</b>	Full luggage rail	Gutter mount*	1.6m x 1.4m	42kg
<b>DA4731</b>	Full luggage rail	Roll cage mount	1.6m x 1.4m	30kg
<b>DA4709</b>	Marine ply floor		1.6m x 1.4m	12kg

Refer to owners handbook for recommended maximum weight.

\*2 roof cross rails as standard and can accommodate 2 additional roof cross rails.





### Safety Devices Roof Racks - 'G4 Expedition' Range



DA4720 / DA4721



DA4718



DA4722



For more Safety Devices roof rack images  
[www.britpart.com/safety-devices-racks](http://www.britpart.com/safety-devices-racks)

#### Safety Devices 'G4 Expedition' Roof Rack Range

An 'all in one' rack without detachable parts and a luggage rail which completely surrounds the roof rack. The roof rack neatly follows the profile of the roof to provide two floor levels and fixes to the rainwater gutter only. This roof rack cannot be fitted to a vehicle where an external roll cage has been fitted.

Includes 4 spotlight brackets at the front and 1 spotlight bracket at the rear. Heavy duty steel roof rack, grit blasted, primed with a zinc enriched powder undercoat, and finished with a durable black powder coat. Standard pack includes a steel roof rack and rain gutter fixing bolts.

**Note** - Not compatible with a sunroof or roof tent.

#### Defender 90 Station Wagon or Hard Top

<b>DA4718</b>	1.9m x 1.2m roof rack with full luggage rail for mounting to rain gutter Dimensions refer to the usable loading area	30kg
<b>DA4719</b>	Marine ply floor (two floor levels) Upper section - 1,220 W x 1,405 L x 10mm H Lower section - 1,220 W x 540 L x 10mm H	12kg
<b>DA4722</b>	Ladder which mounts to roof rack and chassis Only suitable for attaching to DA4718 & DA4720	8kg

#### Defender 110 Station Wagon or Hard Top

<b>DA4720</b>	2.6m x 1.2m roof rack with full luggage rail for mounting to rain gutter Dimensions refer to the usable loading area	40kg
<b>DA4721</b>	Marine ply floor (two floor levels) Upper section - 1,220 W x 2,128 L x 10mm H Lower section - 1,220 W x 540 L x 10mm H	15kg
<b>DA4722</b>	Ladder which mounts to roof rack and chassis Only suitable for attaching to DA4718 & DA4720	8kg

### Safety Devices Roof Racks - Highlander Roof Rack



DA4732



DA4733

#### Safety Devices Highlander Roof Rack

##### DA4732

Discovery 2 with roof rails  
 Highlander roof rack for mounting to the rain gutter.  
 Full luggage rail which neatly follows the profile of the vehicle's roof. 4 light brackets at the front, 1 at the rear. Roof rack will also fit with factory fitted 'oversized' roof bars. Roof racks are grit blasted, primed with a zinc enriched powder undercoat, and finished with a durable black powder coat. Will allow limited use of the sunroofs although cannot be opened fully.  
 Weight: 29kg

##### DA4733

Marine ply floor for DA4732  
 1 floor with 2 'levels' plus all stainless and galvanised hardware for mounting.  
 Weight: 19kg

### Safety Devices Roof Racks - Low Profile Roof Rack



DA4873

#### Safety Devices Low Profile Roof Rack

- DA4736**
- > CNC mandrel bent tubes
  - > Laser profiled plates and tubes
  - > 4mm gloss acrylic capped ABS wind spoiler
  - > All stainless steel fasteners
  - > Load area - 1,950 x 1015mm

- DA4873**
- > Roof rack flooring kit for DA4736
  - > 2,100 x 1,080mm approx
  - > 18kg



# RACKS & ROLL CAGES

## Roof Racks

### ARB BASE Rack

#### ARB BASE Racks

Introducing the next phase in roof rack evolution, the ARB BASE Rack. Ultra-sleek, boasting a low mounting profile and lightweight design, the ARB BASE Rack incorporates a unique dovetail accessory mounting system that makes attaching and removing accessories easier, faster and more secure. When developing ARB's BASE Rack one of the requirements of our engineering team was to have a complete roof rack system - racks, mounts, guard rails and equally important, a wide range of BASE Rack accessories. The dovetail attachment point of the BASE Rack provides a number of advantages to traditional accessory fitment on racks including:

- > Accessories can be fitted anywhere on the dovetail feature either on the perimeter of the rack or on the front or rear of each cross beam. No need to slide along a t-slot with defined entry and exit points.
- > Easy clean dovetail surface does not accumulate dirt and debris.
- > Minimal tools required for fitment of BASE Rack accessories which greatly adds to the modular nature of the rack. Accessories can be quickly and easily removed when not required if there are height restrictions. For example, for low garage entry or an underground car park, and then refitted on the weekend for camping trips.
- > Integrated channel within the BASE Rack structure for wiring of auxiliary lighting, solar panels or antennas.

#### Key Features

- > Constructed from extruded aluminium beams featuring rigid internal bracing
- > Fully welded construction (excluding corner caps)
- > BASE Rack comes fully assembled ready to fit to mount brackets (sold separately)
- > Integrit textured black powder-coat finish
- > Strength through design requires no additional cross bars
- > Dovetail accessory attachment design allows easy to install one handed attachment for various accessories
- > Provision for easy running of wiring within the BASE Rack assembly

\*Not Defender 2020 model

Vehicle Make & Model	BASE Rack	Rack Size	Rack Mount Kit	Rack Guard Rail Front ¼	Rack Guard Rail Trade
Defender*	1770070	1,255 x 1,285mm	17900060	1780020	1780600
Defender*	1770020	1,545 x 1,285mm	17900060	1780020	1780110
Defender*	1770030	1,835 x 1,285mm	17900050	1780020	1780120
Defender*	1770040	2,125 x 1,285mm	17900050	1780020	1780130
Range Rover Classic	1770070	1,255 x 1,285mm	17900020	1780020	1780600
Range Rover Classic	1770020	1,545 x 1,285mm	17900020	1780020	1780110
Range Rover Classic	1770030	1,835 x 1,285mm	17900010	1780020	1780120
Range Rover Classic	1770040	2,125 x 1,285mm	17900010	1780020	1780130

#### Rack Assembly

- > Fully welded construction (excluding corner caps)
- > Comes fully assembled - no additional assembly required to fit the rack to mounting system
- > Controlled welds to ensure that the height of the weld doesn't impede on loading and unloading of the rack

#### Rack Beams

- > Common extruded aluminium cross beams
- > Box piece beam with internal bracing for added strength and rigidity
- > Dovetail on both front and rear of each cross beam allowing for greater flexibility for the location of accessory fitment
- > Beams run perpendicular to the vehicle to greatly assist in strength of the rack and ease of loading and unloading of longer items

#### Rack Longitudinal Side Beams

- > Specific extruded longitudinal side beams features provision for running wiring within the beam through provided blanking plugs
- > Internal bracing greatly adds to strength without added external dimensions
- > Dovetail on exterior edge only

#### Rack Corner Caps

- > Die-cast, UV resistant aluminium corner caps
- > Bottom section is plastic to enable easy drilling for running of wiring

Many more images & technical information available online [www.britpart.com/BASE](http://www.britpart.com/BASE)

Part Number		No. of Beams	Dimensions	Weight (approx)	Carrying Capacity
1770070	BASE Rack	4	1,255 x 1,285mm	14.3kg	100kg
1770020	BASE Rack	5	1,545 x 1,285mm	17.1kg	125kg
1770030	BASE Rack	7	1,835 x 1,285mm	19.9kg	175kg
1770040	BASE Rack	8	2,125 x 1,285mm	22.8kg	200kg

#### ARB BASE Rack Gutter Mount Kits

ARB BASE Rack gutter mount leg kits are based on ARB's traditional roof rack fit kits but now finished in Integrit textured black and with support plates to suit the BASE Rack extrusion. Steel gutter runners with plastic sleeves are included to spread the load within the vehicles roof gutter.

- > Maximum load per BASE Rack beam is 25kg. Net Payload of the rack is dependent on vehicle specifications. Loads must be evenly distributed and adequately secured
- > Required tools for fitment: 10mm spanner, 13mm spanner, hex key (supplied in kit), tape measure

17900020	BASE Rack Gutter 4-leg H1 fitting kit Suits - 1770020 & 1770070	Weight of kit - 6.5kg
17900010	BASE Rack Gutter 6-leg H1 fitting kit Suits - 1770030 & 1770040	Weight of kit - 10kg
17900060	BASE Rack Gutter 4-leg H2 fitting kit Suits - 1770020	Weight of kit - 6.5kg
17900050	BASE Rack Gutter 6-leg H2 fitting kit Suits - 1770030 & 1770040	Weight of kit - 10kg

BUILD | ATTACH | SET | EXPLORE **ARB** BASE RACK



## 4X4 ACCESSORIES

ARB products available in the UK only.

**Note** - Please be aware that with speeds over 50mph you may hear air noise, which will come from rack area. Due to this we strongly recommend to use ARB LED bar, which is designed to decrease noise.



### ARB BASE Rack - Accessories

ARB's BASE Rack has been designed around the premise of **"Build, Attach, Set, Explore"** allowing customers to set up, and importantly, change how the rack is configured and used. When developing ARB's BASE Rack one of the requirements of the engineering team was to have a complete roof rack system - racks, mounts, guard rails and equally important, a wide range of BASE Rack accessories. The dovetail attachment point of the BASE Rack provides a number of advantages to traditional accessory fitment on racks including:

- > Accessories can be fitted anywhere on the dovetail feature either on the perimeter of the rack or on the front or rear of each cross beam. No need to slide along a t-slot with defined entry and exit points.
- > Easy clean dovetail surface does not accumulate dirt and debris.
- > Minimal tools required for fitment of BASE Rack accessories which greatly adds to the modular nature of the rack. Accessories can be quickly and easily removed when not required if there are height restrictions. For example, for low garage entry or an underground car park, and then refitted on the weekend for camping trips.
- > Integrated channel within the BASE Rack structure for wiring of auxiliary lighting, solar panels or antennas.



#### 1/4 Guard Rail

Perfect for campers providing a level mount for a rooftop tent whilst still providing guard rail load security at the front or rear of the rack depending on set up.

**1780020** 1,285mm 3kg  
Suits racks - 1770020/1770030/1770040



**TRADE GUARD RAIL**

#### Trade Guard Rail

Great for loading longer items such as timber or ladders

<b>1780600</b>	1,255mm long	2.3kg	Suits racks - 1770070
<b>1780110</b>	1,545mm long	3kg	Suits racks - 1770020
<b>1780120</b>	1,835mm long	3.5kg	Suits racks - 1770030
<b>1780130</b>	2,125mm long	4kg	Suits racks - 1770040



**1/4 GUARD RAIL**

#### 1780500

#### Slimline LED Roof Rack Light Bar

Complementing the sleek design of the ARB BASE Rack, the light bar uses a uniquely tuned reflector design and pumps out a competitive 1 lux @ 728m with up to 60m of spread. Manufactured from extruded aluminium with high pressure die cast aluminium caps. The body is fully powder coated in a stealth black finish, with a light tint added to the polycarbonate lens. Using the mounting system built into the rack allows the light to be setup in minutes with two different mounting options - in front of the rack or below the rack. All brackets are included with the light. Light bar extras - **3500810** - ARB Light bar wiring loom & **3500820** - ARB Light bar extension loom *Technical Specifications - see website.*

#### Slimline Light Bar Lens Covers

<b>1780510 NEW</b>	Clear x 2 covers
<b>1780511 NEW</b>	Black x 2 covers
<b>1780512 NEW</b>	Amber x 2 covers

Slimline Light Bar is 915mm wide and requires 2 packets of covers (2 x 2 pieces) to provide full protection. Virtually indestructible polycarbonate cover. Clear hard-coated finish UV stable. Specifically designed to suit the ARB Slimline roof rack light bar

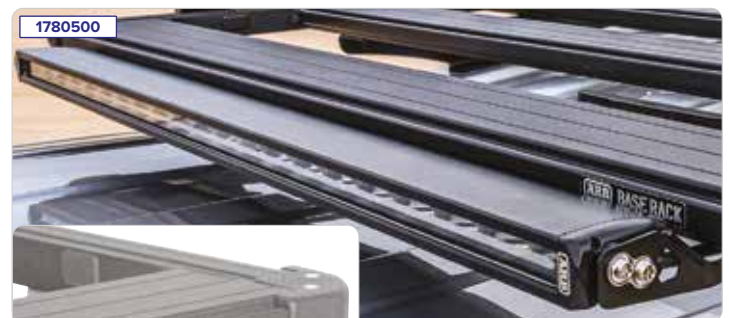

#### 1780520 NEW 20W Aux Light

Includes a unique bracket, over a moulded DT connector suitable for rack channelling, it features an additional DT connector for custom wiring. A scene lighting beam will reduce hot spots in the beam output and reduce glare for reverse cameras. Bracket included along with male and female DT connectors. 9V to 36V input. 20W power consumption/1.5A, 1,100 Lumens @ 5700K. IP69K, ECE, R10, CISPR 25/5 - Compliance. More information available online.



**1780515 NEW**  
**Light Bar Mount - With Front Guard Rail**  
Required when mounting ARB BASE Rack LED Light Bar (1780500) with BASE Rack front section of guard rail. Attaches to dovetail section of rack. Supplied as left hand/right hand pair, includes fasteners for attachment of bracket to rack. Supplied as a pair.



#### 1780490 NEW

#### Light Bar Mount - Underneath

Suitable for single bolt, end mount light bars and work lights. Suitable for mounting small items up to 3.5kg per pair. Can attach to the bottom of rack cross beams using included stud plate and fasteners. Supplied as left hand/right hand pair, includes fasteners for attachment to rack.



#### 1780480 NEW

#### Light Bar Mount - Dovetail

Suitable for single bolt, end mount light bars, work lights and for mounting small items up to 3kg per pair. Can attach to the dovetail on any location of the rack. Brackets made from strong powder-coated steel. Supplied as left hand/right hand pair and includes fasteners.

#### Rack Roller Kits

<b>1780360</b>	Rack Roller Kit	1,025mm
<b>1780365</b>	Rack Roller Kit	1,185mm

The roller helps your equipment to glide onto the rack making it easy to load the rack. Can attach to the dovetail track anywhere on the perimeter. Made from powder-coated aluminium. Full-width, low-profile roller.



#### Jerry Can Holders

<b>1780350</b>	Double - Horizontal
<b>1780340</b>	Double - Vertical*
<b>1780330</b>	Single - Horizontal
<b>1780320</b>	Single - Vertical*

Allows easy fitment jerry cans to your BASE Rack. Double holders secure to two beams, single to one beam or spans between beam. Strap included. \*Provision for water tap.



#### 1780380

#### Spare Wheel Y-Strap

These effective ratchet strap systems secure the tyre in three points on the rack. The unique dovetail clip which offers a positive connection directly to the rack at all three points. 400lbs lashing capacity to AS/NZS4380:2001 Adjustable one inch straps suit most tyre sizes. Supplied with carry bag.



#### 1780385 NEW

#### Spare Wheel Y-Strap With Snap-Lock Hooks

Design features include a tether strap and snap lock hooks, which in combination positively retain the spare wheel and tyre even in the event of the spare wheel deflating. The tether strap also improves retaining of a tyre carcass only. Work conveniently with rack eye bolt tie-downs (not included).



#### 1780250

#### Gas Bottle Holder

Perfect for carrying a 2kg - 9kg gas bottle, comes complete with the base, ratchet strap and two fixing eye bolts and can be secured to an individual beam or span between beams. Eye bolts and strap included to secure the gas bottle. Durable baseplate with adjustable stainless steel locking bracket.



# RACKS & ROLL CAGES

## Roof Racks

### ARB BASE Rack - Accessories



**1780210**  
**Spring Loaded Tie Down**  
Quick-attach spring-loaded tie-downs are easy to use with a simple one-handed operation. The tie-downs twist on & twist off. Provides a lashing point for ratchet straps. Designed to be taken off the rack when not in use by a simple half turn. Made from stainless steel. Pair.



**1780370**  
**Ratchet Straps**  
Ensure all your gear is safe and secure on your BASE Rack with these ratchet straps. They form a positive connection with the rack so there is no need for additional tie-down points. 25 x 3,000mm polyester webbing, 330lbs lashing capacity to AS/NZS4380:2001. Supplied with carry bag. Pair.



**1780280**  
**Hi-Lift™ Jack Premium Brackets**  
Quick-release loading and unloading of jack with two hinged cradles. It incorporates provisions for a padlock to secure the jack to your vehicle. Can be mounted in the foot up or foot down position and positioned anywhere on the dovetail track on the perimeter. Made from strong, powder-coated steel.



**1780290**  
**Hi-Lift™ Jack Classic Brackets**  
The Classic jack holder keeps the jack secure with two eye bolts attached directly to the dovetail. The jack can be mounted in either the foot up or foot down position. Can attach to the dovetail track anywhere on the perimeter. Made from strong, corrosion-resistant steel. Includes rubber handle keeper.



**T-slot Adaptors**  
**1780220 NEW** Single  
**1780230** Pair  
For use with your existing T-slot compatible accessories. Allows fitment of accessories from a range of roof rack manufacturers. Uses a standard T-slot channel to accept T-slot mounted accessories. Can attach to the dovetail track at any point on the rack.



**Recovery Track Holder**  
**1780310** Holder  
**T2QP112** Quick Release Pins - 2 Boards  
**T2QP162** Quick Release Pins - 4 Boards  
4 piece fastening kit suitable for use with TRED Pro mounting systems. Can attach to the dovetail track at any point on the rack. Made from strong, corrosion-resistant steel.



**1780610 NEW**  
**Alloy Block Set - Nut & Bolt Kit**  
Powder-coated aluminium blocks. Can attach to the dovetail on any location of the rack. Set of 4.



**1780200**  
**Tie Down Eyebolts**  
These eye bolt tie-downs are built tough to handle any load and terrain and provide a lashing point for ratchet straps. Design to stay securely on the BASE Rack when not in use. Made from strong, powder-coated aluminium with forged steel eye nuts. Set of 4.



**Awning Brackets**  
**1780240** Fixed  
**1780260** Quick-release  
The Awning Bracket allows quick fitment of your awning. Easy to attach to the BASE Rack, simply secure onto the dovetail track on the rack, can be attached at any point. Height adjustable. Made from strong, powder-coated steel.



**1780390 NEW**  
**Heavy Duty Awning Bracket**  
Suits 270° awnings up to 30kg. Integrated eye nut tie down points. Attaches to outer perimeter dovetail and cross beam. High and low mount position for awning. Quick release slots for easy install and removal of awning to bracket. Includes bracket for additional hook point (if supplied) with awning.



**1780420 NEW**  
**Bridge Plate - Narrow**  
Provides a strong, versatile attachment point. Ideal for mounting rooftop tents. Can be used as a clamped pair or mounted individually.



**1780430 NEW**  
**Bridge Plate - Wide**  
Suitable for mounting aerials, sand flags, some beacons, and round driving lights with 1780610 alloy blocks. Can be used as a clamped pair or mounted individually using 1780610 alloy blocks. Mounts between cross beams.



**1780440 NEW**  
**Horizontal Mount - Narrow**  
Provides a strong, versatile, horizontal attachment point to your BASE Rack. Suitable for mounting small items up to 3kg per bracket including work lights, aerials, solar panels. Can attach to the dovetail on any location of the rack.



**1780450 NEW**  
**Horizontal Mount - Wide**  
Provides a strong, versatile, horizontal attachment point to your BASE Rack. Suitable for mounting small items up to 6kg per bracket including work lights, aerials, solar panels. Can attach to the dovetail on any location of the rack.

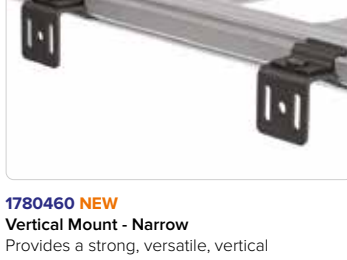

**1780460 NEW**  
**Vertical Mount - Narrow**  
Provides a strong, versatile, vertical attachment point to your BASE Rack. Suitable for mounting small items up to 3kg per bracket including work lights, solar panels. Can attach to the dovetail on any location of the rack.



**1780470 NEW**  
**Vertical Mount - Wide**  
Provides a strong, versatile, vertical attachment point to your BASE Rack. Suitable for mounting small items up to 6kg per bracket including work lights, conduit holders. Can attach to the dovetail on any location of the rack.



**1780270 NEW**  
**Shovel Holder**  
With its unique 4 mounting positions, the Shovel Holder can be fitted to all rack configurations allowing for various shovel or spade sizes & configuration of other accessories. A unique flip down, quick release retaining system ensures high clamping force and ease and speed of use. The custom designed retaining system is also lockable.



**ARB BASE RACK**

Learn more about BASE at  
[www.britpart.com/BASE](http://www.britpart.com/BASE)



### ARB Classic Roof Racks

DELUXE STEEL WITH MESH FLOOR TYPE



DELUXE STEEL TYPE



### 4X4 ACCESSORIES

ARB products available in the UK only.

#### Features

- > Evenly spaced crossbars can support loads of up to 150kg, with an optional fully welded steel mesh floor also available.
- > Precision cut drainage channel, specifically designed to reduce build up of dirt and accumulation of moisture.
- > Full length, zinc annealed steel support channel with plastic protection strip to distribute load along the gutter and prevent vehicle damage.
- > Stainless steel fitting hardware and a unique, super-strong clamping system that's easy to install and remove.
- > MIG welding is used on the joins to ensure optimum strength.
- > Pressed steel feet and legs are height & width adjustable, allowing multi-vehicle installations.
- > Top rail sits well above rack floor to ensure a secure load and is constructed from tough, 25mm tube while the bottom rail utilises 35mm tubing.
- > Air deflector plate significantly reduces wind noise.
- > Rails are mandrel formed, ensuring consistency and even wall thickness across all sections.

3700090



TRADE STEEL TYPE



Rack shows accessories not supplied with roof rack.

TRADE STEEL WITH MESH FLOOR TYPE



ARB's Trade Racks are available as an alternative to deluxe racks for a selection of models. Open at both ends, a trade rack enables the carrying of longer items, such as lengths of timber and ladders.

#### Defender 90/Defender 110 - Dual Cab

##### Defender 130 - Dual Cab

Roof Rack Type	Roof Rack Size	Roof Rack Part Number	Roof Rack Fitting Kit Part Number
Deluxe steel	1,850 x 1,350mm	3800110	3700030
Deluxe steel with mesh floor	1,850 x 1,350mm	3800110M	3700030
Trade steel	1,850 x 1,350mm	3800113	3700030
Trade steel with mesh floor	1,850 x 1,350mm	3800113M	3700030
Deluxe steel	1,100 x 1,350mm	3800120	3700040
Deluxe steel with mesh floor	1,100 x 1,350mm	3800120M	3700040

##### Defender 110 - Station Wagon

Deluxe steel with mesh floor	3,000 x 1,350mm	3800130M	3700040 x 2
Deluxe steel	2,200 x 1,350mm	3800100	3700030
Deluxe steel with mesh floor	2,200 x 1,350mm	3800100M	3700030
Trade steel	2,200 x 1,350mm	3800103	3700030
Deluxe steel	1,850 x 1,350mm	3800110	3700030
Deluxe steel with mesh floor	1,850 x 1,350mm	3800110M	3700030
Trade steel	1,850 x 1,350mm	3800113	3700030
Trade steel with mesh floor	1,850 x 1,350mm	3800113M	3700030
Deluxe steel	1,100 x 1,350mm	3800120	3700040
Deluxe steel with mesh floor	1,100 x 1,350mm	3800120M	3700040

##### Discovery 1/Discovery 2

Deluxe steel	1,100 x 1,350mm	3800120	3700090
Deluxe steel with mesh floor	1,100 x 1,350mm	3800120M	3700090

### Thule



Gutter Mount Fitment



Clamp Style Fitment



Raised Roof Rail Fitment

#### Gutter Mount Fitment Roof Bars

DA2991	Discovery 2	1,630mm wide
DA3002	Range Rover Classic	1,500mm wide

#### Clamp Style Fitment Roof Bars

DA4326	Freelander 2	1,350mm wide
DA2996	Range Rover Sport - 2005 - 2013	1,500mm wide

#### Raised Roof Rail Fitment Cross Bars

DA4323	Discovery 2 - up to 2003	1,350mm wide
DA4329	Freelander 1	1,080mm wide

Maximum load weight of 80kg.  
Complete with a pair of black square bars.



Britpart



# RACKS & ROLL CAGES

## Safety Devices Roll Cages



Thinking of taking your 4x4 over rough terrain? You might want to consider using a Safety Devices roll cage to help protect you in case of a roll over. The purpose of a roll cage is to help protect the cab of the vehicle against collapse.



**Roll Cage Raised Air Intake Now Available**  
See off-road section for more details

For more Safety Devices roll cage images  
[www.britpart.com/roll-cages](http://www.britpart.com/roll-cages)

### Defender 110

<b>RBL2057SSS</b> Defender 110 With front external roll cage and rear internal roll cage	<b>8 Point multi-point bolt-in full roll cage</b> Td5 Double Cab Pickup 4-door - 1998 - 2006	Black	<b>RBL2507SSS</b> Defender 110 Defender 110 One Ten	<b>8 Point multi-point external front/internal rear bolt-in roll cage</b> Td5 - Soft top 2-door - 1998 - 2006 300Tdi - Soft top 2-door - 1994 - 1997 200Tdi - Soft top 2-door - 1990 - 1993 Soft top 2-door - 1983 - 1990	Black
<b>RBL1907SSS</b> Defender 110 Made to NAS specification	<b>Full external multi-point bolt-in roll cage</b> Hard Top, 2-door	Black	<b>Note</b> - Will only fit models with a bulkhead. Utilises existing hood which will need modification. Front legs are NAS style. We strongly recommend fitting roll cage padding when installing this roll cage.		
<b>RBL1727SSS</b> Defender 110	<b>8 Point full external/internal roll cage</b> Station Wagon, 4-door	Black	<b>RBL1837SSS</b> Defender 110 Defender 110 One Ten	<b>10 Point multi-point bolt-in external front roll cage with NAS front underwing mounts and internal full length rear roll cage</b> Td5 - Station Wagon 5-door - 1998 - 2006 300Tdi - Station Wagon 5-door - 1994 - 1997 200Tdi - Station Wagon 5-door - 1990 - 1993 Station Wagon 5-door - 1983 - 1990	Black
<b>RBL1727PAD</b> Defender 110	<b>Internal roll cage padding</b> Station Wagon, 4-door	Black	<b>Note</b> - Models between 1983 - 1988 had 3 raised ribs on the roof approx 22mm tall. This kind of roof does not work with our external roll cages as the hoops will clash with them.		
<b>RBL2427SSS</b> Defender 110	<b>6 Point full external roll cage</b> Station Wagon, 4-door	Black	<b>RBL2447SSS</b> Defender 110	<b>Heavy-duty hood stick set</b> 200Tdi soft top 2-door - 1990 - 1993	Black
<b>RBL1857SSS</b> Defender 110	<b>10 Point full external bolt-in roll cage</b> Crew/Double cab pick-up 4-door - 1983 onwards	Black	<b>Set completely replaces soft-top hood sticks. 45mm tube diameter, no diagonal, backstays to waist rail, includes front belt anchor points.</b>		
<b>RBL0117SSS</b> Defender 110	<b>4 Point bolt-in internal rear 'half' roll cage</b> Station Wagon - 4-door - 1983 - 2006	Black			
<b>RBL2557SSS</b> Defender 110	<b>4 Point bolt-in internal rear 'half' roll cage</b> Station Wagon - 4-door - 2007 onwards	Black			
<b>RBL2437SSS</b> Defender 110	<b>6 Point full external bolt-in roll cage</b> Double Cab Pickup - 4-door - 2007 - 2015	Black			
<b>RBL1487SSS</b> Defender 110 Defender 110 Defender 110 One Ten	<b>8 Point multi-point internal 'half' roll cage with external front legs</b> Td5 - Station Wagon 5-door - 1998 - 2006 300Tdi - Station Wagon 5-door - 1994 - 1997 200Tdi - Station Wagon 5-door - 1990 - 1993 Station Wagon 5-door - 1983 - 1990	Black			
<b>Note</b> - Models between 1983 - 1988 had 3 raised ribs on the roof approx 22mm tall. This kind of roof does not work with our external roll cages as the hoops will clash with them.					



*Add some extra protection to your Land Rover*









# RACKS & ROLL CAGES

## Safety Devices Roll Cages

### Defender 130

**RBL2477SSS** 8 Point multi-point external bolt-in roll cage with internal B hoop Black  
 Defender 130 Puma Double Cab High Capacity Pick Up 4-door - 2007 onwards  
 Defender 130 Td5 Double Cab High Capacity Pick Up 4-door - 1998 - 2006  
 Defender 130 300Tdi Double Cab High Capacity Pick Up 4-door - 1994 - 1997  
 Defender 130 200Tdi Double Cab High Capacity Pick Up 4-door - 1990 - 1993

**Note** - The rear provides sufficient clearance to allow the original rear canvas to be left in place with only a small modification required each side at the rear.

**RBL2607SSS** 6 Point multi-point external bolt-in roll cage Black  
 Defender 130 Puma Double Cab High Capacity Pick Up 4-door - 2007 onwards  
 Defender 130 Td5 Double Cab High Capacity Pick Up 4-door - 1998 - 2006  
 Defender 130 300Tdi Double Cab High Capacity Pick Up 4-door - 1994 - 1997  
 Defender 130 200Tdi Double Cab High Capacity Pick Up 4-door - 1990 - 1993

**Note** - The rear provides sufficient clearance to allow the original rear canvas to be left in place with only a small modification required each side at the rear.

**RBL2587SSS** 8 Point bolt-in internal/external bolt in roll cage with internal B hoop Black  
 Defender 130 Puma Double Cab High Capacity Pick Up 4-door - 2007 onwards  
 Defender 130 Td5 Double Cab High Capacity Pick Up 4-door - 1998 - 2006  
 Defender 130 300Tdi Double Cab High Capacity Pick Up 4-door - 1994 - 1997  
 Defender 130 200Tdi Double Cab High Capacity Pick Up 4-door - 1990 - 1993

**RBL2497SSS** 8 Point bolt-in full external/internal roll cage Black  
 Defender 130 Puma - Station Wagon 4-door - 2007 onwards  
 Defender 130 Td5 - Station Wagon 4-door - 1998 - 2006  
 Defender 130 300Tdi - Station Wagon 4-door - 1994 - 1997  
 Defender 130 200Tdi - Station Wagon 4-door - 1990 - 1993

We strongly recommend fitting roll cage padding when installing this roll cage.

**RBL2587SSS**



### Defender 90, 110 & 130

**RBL2303SSS** Full external style bar Silver  
**RBL2303SSSBLACK** Full external style bar Black  
 Defender 90 Hard Top with bulkhead, 2-door  
 Defender 90 Hard Top without bulkhead, 2-door  
 Defender 90 Station Wagon without bulkhead, 2-door  
 Defender 90 Station Wagon with bulkhead, 2-door  
 Defender 110 Hard Top, 2-door  
 Defender 110 Station Wagon, 4-door  
 Defender 110 Crew Cab/Double Cab Pick-up, 4-door  
 Defender 130 Station Wagon, 4-door  
 Defender 130 High Capacity Crew Cab Double Cab Pick-up, 4-door  
**RBL1383SSS** 4 Point external front roll cage Black  
 Defender 90 Station Wagon without bulkhead, 2-door  
 Defender 90 Station Wagon with bulkhead, 2-door  
 Defender 110 Station Wagon, 4-door  
 Defender 110 Crew Cab/Double Cab Pick-up, 4-door



**RBL2303SSS**

For more Safety Devices roll cage images  
[www.britpart.com/roll-cages](http://www.britpart.com/roll-cages)

### Freelander 1

**RBL1506SSS** 14 point multi-point bolt-in competition internal roll cage for cross door bars

Black  
 Freelander 1  
 3-door & 5-door  
 Rear roll cage has cross diagonal in backstays, harness bars, tunnel brace & lower backstays.

**RBL150FFK**  
 Fitting kit for RBL1506SSS

**RBL1506SSS**

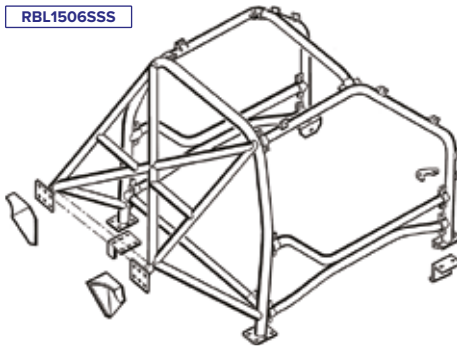

### Roof Tent Mounting Bracket



**20-6000-755**  
 Suitable for any Safety Devices Expedition external roll cage, as well as other roll-cages using 45mm diameter tubing.

### Roll Cage Ladder

**RBL0526SSS**  
**Ladder**  
 Black  
 A rear ladder mounted from Safety Devices' Defender 90 and 110 roll cage and Defender lower chassis mounting points.



### Accessory/Rack Mount Clamps



**DACS001**

**SACS001**



**DACS001** Double clamp Single



**SACS001** Single clamp Single

For mounting accessories such as a roof-rack, snorkel or aerial to your roll cage. Suitable for any Safety Devices Expedition external roll cage, as well as any other roll cage which uses 45mm diameter tubing. The upper mounting hole is M8 threaded.

- > Anodized clamp - upper and lower sections
- > Protective rubbers - protects roll cage finish
- > M8 stainless bolts and spring washers





<b>DA1089*</b>	Defender 90/110 Series SWB/LWB	Galvanised Non-drill type
<b>DA3073*</b>	Defender 90/110	Grey
<b>DA3073B*</b>	Defender 90/110	Black
<b>DA4710</b>	Defender 90/110 Safety Devices	Left hand side Black
<b>DA3285 NEW</b>	Defender 90/110 Safety Devices	Right hand side Black
<b>RBL0526SSS</b>	Defender 90/110	Black
<b>STC50417</b>	Defender 90/110	Black
<b>STC50134</b>	Discovery 2	Black
<b>VPLER0196LR NEW</b>	Defender - 2020	Deployable Black

\*Note - Please check as DA1089, DA3073 & DA3073B partially covers the number plate and may not comply with your country's MOT regulations.



**DA4118** 4 Bikes  
Discovery 1 - mount to the spare wheel carrier & easy to fit

**DA4119** 4 Bikes  
Discovery 2 - mount to the spare wheel carrier & easy to fit

**DA4121** 3 Bikes  
Freelander 1 - mount to the spare wheel carrier & easy to fit

**STC50063LR** 2 Bikes  
Discovery 2/Discovery 3/Discovery 4  
Range Rover Sport - 2005 - 2013

**VPLFR0091** 1 Bike  
Thule cycle carrier. Raised roof rails & crossbar kit required  
More information online - [www.britpart.com/bike](http://www.britpart.com/bike)



Photo by Richard Rushton



# RACKS & ROLL CAGES

## Load Securing Systems

### BungeeClic Load Securing System

#### DA5040

- > BungeeClic, a complete system for securing loads and objects
- > It can be customised in a variety of ways to build the correct length ties needed for securing a variety of objects
- > It gives you all you need to build and adjust safe custom-length ties to suit your needs and requirements
- > No more unsafe coupling or wrong lengths
- > It can be used to secure loads at work, at home or out camping
- > Min/max working load for all items - 0 - 80kg

#### Kit Contents

- 2 x J-hooks
- 2 x Locking hooks
- 1 x Straight connector
- 1 x 90 - 135cm bungee cord
- 1 x 60 - 90cm bungee cord
- 1 x 30 - 45cm bungee cord



DA5040



DA5040

DA5043



#### Bungee Clic Additional Accessories

<b>DA5043</b>	BungeeClic Straight connectors	Twin pack	Straight connectors provide precision length for every job.
<b>DA5044</b>	BungeeClic Y connector	Single pack	Y connectors allow you to build netting shapes
<b>DA5045</b>	BungeeClic Wall mounts	Twin pack	The Wall mount offers solid and permanent anchoring; inside your Land Rover or behind any door.
<b>DA5046</b>	BungeeClic Adjustable hooks	Twin pack	The adjustable hooks let you quickly adjust and set the bungee cord the right length and position.
<b>DA5047</b>	BungeeClic 30cm cords	Twin pack	30cm extends up to 45cm
<b>DA5048</b>	BungeeClic 60cm cords	Twin pack	60cm extends up to 90cm
<b>DA5049</b>	BungeeClic 90cm cords	Twin pack	90cm extends up to 135cm
<b>DA5050</b>	BungeeClic 120cm cords	Twin pack	120cm extends up to 160cm



DA5045



DA5046



DA5047

DA5048

DA5049

DA5050



### External & Internal Tie Down Points



#### ARB Track Tie Down System LK01A

45mm Track & Load Rings - Pair  
Anodised and powder coated for superior protection against the elements. Perfect for internal or external mounting on vehicles. Chamfered ends on tracks.

*Customised in a variety of ways & used to secure loads at work, at home or out camping.*

### Ratchet & Cambuckle Straps

#### DA1267

2m - pair

DA1267

#### ARB Cargo Gear Straps RT11A

32mm x 3m

#### RT06A

50mm x 5m

High quality polyester webbing finished in safety orange with reflective branding. Zinc plated for longevity and corrosion resistance. Rubber handles & silicone coated cam sleeves. Storage bag included. Single.



RT11A

CT02

#### ARB's Cambuckle Tie Downs CT02

25mm x 1.8m

#### CT02A NEW

25mm x 3.0m

Provide a quick and easy solution to securing your load to racks, trailers and cargo areas. Polyester webbing. Zinc alloy cambuckle. Lashing capacity - 340kg. Pack of 2. ARB products available from UK stockists only.

### Safety Devices Seat Belt Anchorage Frame



#### DA3554 NEW

Series 2

Series 2A

Series 3

Defender

**Note** - Will **NOT** fit a Lightweight or Series 1

This Safety Devices seat belt anchorage frame is designed to provide a robust belt mounting in Soft Top models.



Manufactured from 38.1mm x 2.64mm seamless tube, the frame provides both upper inertia seat belt reel mounting points and also provides upper harness mounting points when wrapped around the tube.

The frame fits directly over the existing canopy support brackets and has rearwards supports which also mount to the capping.



**RRL2290FRS**

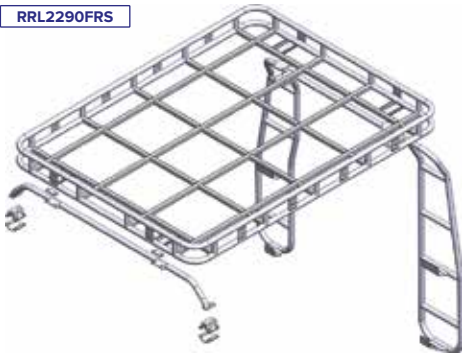

**Defender 90 Soft Top Roof Racks**

Roof racks for mounting to RBL1887SSS / RBL2997SSS. Rack covers the full length of vehicle.

Kit includes double rear ladder and cross rail.

<b>RRL2290FRS NEW</b>	2.0m x 1.4m	Full luggage rail
<b>RRL2290LRS NEW</b>	2.8m x 1.4m	Long luggage rail
<b>RRL2290SRS NEW</b>	2.8m x 1.4m	Short luggage rail
<b>RRL2290NRS NEW</b>	2.8m x 1.4m	No luggage rail

**RRL2290LRS**

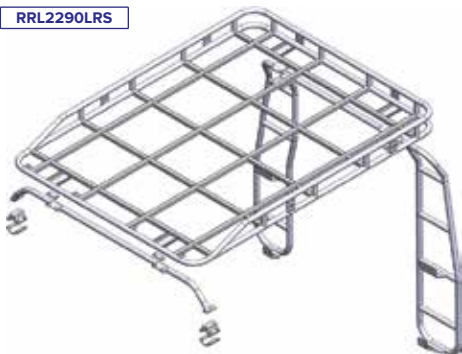

**Defender 110 4-door Soft Top Roof Racks**

Roof racks for mounting to RBL3087SSS. Rack covers the rear section of the vehicle only, the area directly above the front row of seats is clear.

Kit includes double rear ladder and cross rail.

<b>RRL2290FRS NEW</b>	2.0m x 1.4m	Full luggage rail
<b>RRL2290LRS NEW</b>	2.8m x 1.4m	Long luggage rail
<b>RRL2290SRS NEW</b>	2.8m x 1.4m	Short luggage rail
<b>RRL2290NRS NEW</b>	2.8m x 1.4m	No luggage rail

**RBL3087SSS NEW**

**External/Internal 10-point multi-point external/internal bolt-in roll cage**

External front cage that passes through the canvas behind the doors to join the internal C hoop. Features an internal hoop at the B pillar which connects internally to the rear hoop at the C pillar. Includes mountings for door frame hardware and is designed to have the same profile as traditional hood stick supports. We strongly recommend fitting the roll cage padding kit when installing this roll cage.

110	5-door Soft top - 1983 - 1990
Defender 110	200Tdi 5-door Soft top - 1990 - 1993
Defender 110	300Tdi 5-door Soft top - 1994 - 1997
Defender 110	Td5 5-door Soft top - 1998 - 2006
Defender 110	Puma 5-door Soft top - 2007 - 2015

**RRL2320SRS**

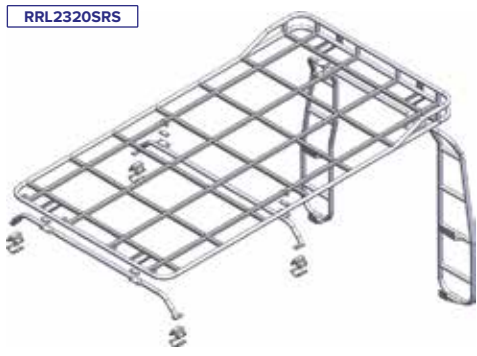

**Defender 110 4-door Soft Top Roof Racks**

Roof racks for mounting to RBL3087SSS. Rack covers the full length of vehicle.

Kit includes double rear ladder and cross rail.

<b>RRL2320FRS NEW</b>	2.8m x 1.4m	Full luggage rail
<b>RRL2320LRS NEW</b>	2.8m x 1.4m	Long luggage rail
<b>RRL2320SRS NEW</b>	2.8m x 1.4m	Short luggage rail
<b>RRL2320NRS NEW</b>	2.8m x 1.4m	No luggage rail

**RRL3156SSS NEW**

Double rear ladder which mounts to existing fixings in the rear crossmember and also to the capping either side of the rear door. Designed to allow the fitment of an Explorer roof rack to a Soft Top vehicle fitted with the following Safety Devices

Internal/External roll cages: RBL1887SSS

- Defender 90 - 2-door RBL2997SSS
- Defender 90 - 2-door RBL3087SSS
- Defender 110 - 4-door

The ladder is used in conjunction with the following front cross rails:

- RRL315RR-RC-XRA NEW**
- RRL315RR-RC-XRB NEW**



Thinking of taking your 4x4 over rough terrain? You might want to consider using a Safety Devices roll cage to help protect you in case of a roll over. The purpose of a roll cage is to help protect the cab of the vehicle against collapse.

**RBL3097SSS NEW**

**Internal 8 point multi-point internal bolt-in roll cage**

Internal rear cage spanning from B pillar to rear of the vehicle. Includes mountings for door frame hardware and is designed to have the same profile as traditional hood stick supports. We strongly recommend fitting the roll cage padding kit when installing this roll cage.

110	5-door Soft top - 1983 - 1990
Defender 110	200Tdi 5-door Soft top - 1990 - 1993
Defender 110	300Tdi 5-door Soft top - 1994 - 1997
Defender 110	Td5 5-door Soft top - 1998 - 2006
Defender 110	Puma 5-door Soft top - 2007 - 2015

**RRL2450NRS**

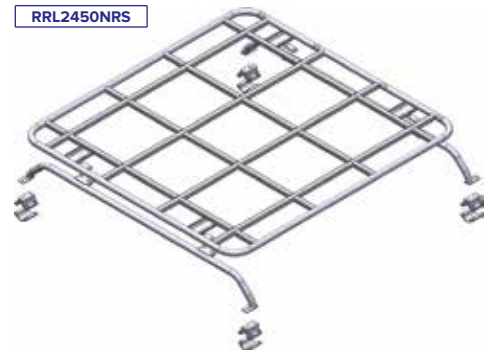

**Defender 110 4-door Soft Top Roof Racks**

Roof racks for mounting to RBL3087SSS.

Rack mounts to front external cage only, covering the front half of the vehicle, not over the rear.

Kit not suitable for double rear ladder

<b>RRL2450FRS NEW</b>	1.6m x 1.4m	Full luggage rail
<b>RRL2450LRS NEW</b>	1.6m x 1.4m	Long luggage rail
<b>RRL2450SRS NEW</b>	1.6m x 1.4m	Short luggage rail
<b>RRL2450NRS NEW</b>	1.6m x 1.4m	No luggage rail



**New to Range JUST ADDED**

**RBL3107SSS NEW**

**External/Internal 10 point multi-point external/internal bolt-in roll cage**

External front cage section which joins to an internal rear section at the B pillar. Also features an internal hoop at the B pillar which connects internally to the rear hoop at the C pillar. We strongly recommend fitting the roll cage padding kit when installing this roll cage.

110	5-door Soft top - 1983 - 1990
Defender 110	200Tdi 5-door Soft top - 1990 - 1993
Defender 110	300Tdi 5-door Soft top - 1994 - 1997
Defender 110	Td5 5-door Soft top - 1998 - 2006
Defender 110	Puma 5-door Soft top - 2007 - 2015

**RBL3167SSS NEW**

**External/Internal 12-point bolt in external/internal roll cage**

External front cage that passes through the door to join the internal section. Rearward mounted B hoop, so requires 1 x OEM hood stick in front of B hoop to mount door hardware to. Designed to be used only on vehicles equipped with OEM/Land Rover bulkhead replacement bar - it may not work with after-market alternatives. We strongly recommend fitting the roll cage padding kit when installing this roll cage.

Defender 110	Td5 2-door Soft top - 1998 - 2006 without bulkhead behind seats
Defender 110	Puma 2-door Soft top - 2007 - 2015 without bulkhead behind seats

**RBL3177SSS NEW**

**Heavy-duty 10-point bolt-in internal rear heavy duty hood stick replacement.**

Forward hoop position, so B hoop includes front seat belt upper anchor points, mountings for door frame hardware and backstays that mount to the capping. Rear hoop includes upper and lower mountings for forward facing seats. Designed to be used only on vehicles equipped with OEM/Land Rover bulkhead replacement bar - it may not work with after-market alternatives. We strongly recommend fitting the padding kit when installing this heavy-duty hood stick replacement.

Defender 110	Td5 2-door Soft top - 1998 - 2006 without bulkhead behind seats
Defender 110	Puma 2-door Soft top - 2007 - 2015 without bulkhead behind seats







### DA3565 NEW

#### Roof Rack

Defender 110 & 110 Hard Top - 2020 onwards  
Roof rack assembly complete with wind deflector bib. Requires the installation of roof rails (VPLER0177) to allow fitment. No modification to the vehicle is required and the rack does not obscure the rear-view camera. Top of rack is 125mm above roof skin, measured directly behind the rear-view camera. Provides clearance for the panoramic sunroof to both tilt and open fully. The roof rack is compatible with the access ladder and accessory rack.



### DA3566 NEW

#### Access Ladder

Defender 90 & 90 Hard Top - 2020 onwards  
Defender 110 & 110 Hard Top - 2020 onwards  
Defender 130 - 2020 onwards  
Roof access ladder that can be fitted to either side of the vehicle. It can be installed standalone or in conjunction with the Safety Devices Roof Rack Assembly. Made of a folding construction with dual securing methods and a key locking mechanism. Requires drilling of the trim panels below the rear window to allow installation into the existing body mounts beneath. When deployed, the height from the floor to the lowest step of the ladder is 585mm at normal ride height (660mm at max and 550mm at min).

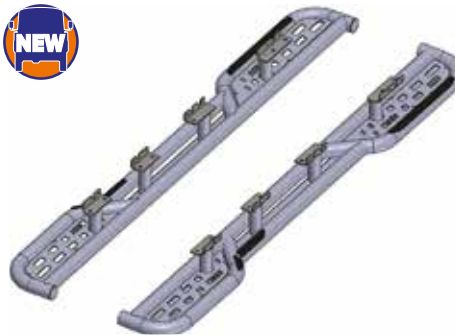

### DA3567 NEW

#### Side Steps

Defender 110 & 110 Hard Top - 2020 onwards  
Defender 130 - 2020 onwards  
Side steps and toe rail kit with non-slip tape and stainless-steel infill plates. Designed to mount on existing mounts within the sill. The plastic sill covers will require slight modification to allow access to the mounting points. Supplied with an adapter to allow the OEM jack to be used.

**Note** - Kick rail not shown in drawing.



### DA3568 NEW

#### Accessory Rack

Defender 90 & 90 Hard Top - 2020 onwards  
Defender 110 & 110 Hard Top - 2020 onwards  
Defender 130 - 2020 onwards  
Multi-purpose accessory mount that can be fitted to either side of the vehicle. It can be installed standalone or in conjunction with the Safety Devices Roof Rack Assembly. Features mounting rails along upper and lower sides along with 4 x tie down points. Requires drilling of the trim panels below the rear window to allow installation into the existing body mounts beneath.



### DA3569 NEW

#### Spare Wheel Cradle

Defender 90 & 90 Hard Top - 2020 onwards  
Defender 110 & 110 Hard Top - 2020 onwards  
Defender 130 - 2020 onwards  
Designed to work with the existing spare wheel carrier as a cradle to rest the wheel on whilst attaching with bolts. Uses existing mounts in the rear door with no modifications required.

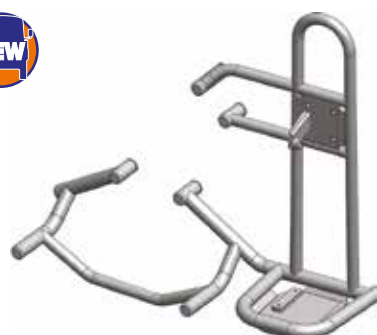

### DA3570 NEW

#### Spare Wheel Cradle & Off Road/Trail Jack Mount

Defender 90 & 90 Hard Top - 2020 onwards  
Defender 110 & 110 Hard Top - 2020 onwards  
Defender 130 - 2020 onwards  
Designed to work with the existing spare wheel carrier as a cradle to rest the wheel on whilst attaching with bolts. Uses existing mounts in the rear door with no modifications required. Also provides the provision to mount an Off Road/Trail Jack in a vertical orientation.

**New to Range  
JUST ADDED**



*Smarten Up Your Land Rover With A New Set Of Wheels*



# WHEELS



# WHEELS

## Wheels

### Alloy Wheels

ANR3631MNH



ANR5307MNH



RRC503400MNH



RRC501470MCM



RRC505360MNHRLR



RRC505370MNHRLR



Defender				Range Rover			
ANR3631MNH		16" x 7	Deep Dish alloy	RRC501470MCM	Range Rover P38	18" x 8	Hurricane alloy
ANR5307MNH	TA onwards	16" x 7	Tornado alloy	RRC505360MNHRLR	Range Rover Sport - 2005 - 2009	10-spoke alloy	
RRC503400MNH	1994 onwards	16" x 7	Boost alloy			18" x 8	Silver sparkle finish
				RRC505370MNHRLR	Range Rover Sport - 2005 - 2009	10-spoke alloy	
						19" x 9	Silver sparkle finish

**Note** - Centre caps and wheel nuts not included with any wheels.  
*Note - It is the responsibility of the vehicle owner to ensure that the wheels fitted to their vehicle have an appropriate load rating. The minimum required load rating can be determined by taking the manufacturers recommended maximum axle weight & dividing by two.*

Enhance your Land Rover with a set of smart new wheels

### Beadlock Steel Wheels

DA3239



DA3238



**DA3239**  
**16 x 10" Steel Beadlock Wheel**  
 The steel bead lock wheel is a seriously tough wheel specifically for hard core off-road use where very low tyre pressures risk rolling a tyre off the rim.  
 > For off-road use only  
 > Loading - 1,200kg  
 > ET/OS -32  
 > Weight - 19.5kg

**DA3238**  
**16 x 10" Steel Imitation Beadlock Wheel**  
 Imitation bead lock wheel looks the part of the real bead lock design with the added bonus of being road legal.  
 > Road legal  
 > Loading - 1,200kg  
 > ET/OS -32  
 > Weight - 17.5kg

DA3239

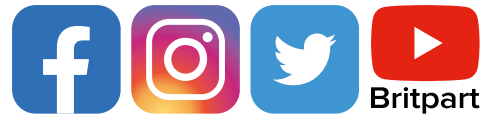

### Alloy Wheel Cap

**NRC8254LR NEW**  
 Range Rover Classic - 1986 - 1994  
 Black  
 Single





**Caradoc - Alloy Wheels**

- DA3521 NEW** 16" x 8" Caradoc alloy
- DA3522 NEW** 18" x 9" Caradoc alloy
- DA3523 NEW** Centre cap for DA3521 & DA3522
- DA2474** Set of 5 spare wheel nuts
- DA2475** Set of 5 locking wheel nuts

- > Smart Anthracite finish
- > Fits all Defender including early 90/110/130
- > Offers a deep dish, wider offset
- > Significantly improves turning circle at the same time as enhancing on road handling.
- > ET0 off set, meaning no need for the use of spacers, they sit in the widest position
- > PCD - 5 x 165.1
- > 1,100kg load rating
- > Wheel nuts (not locking) included

DA3521



DA3522



DA3523



**MaxXtrac - Blindo Alloy Wheels**

- Defender
- Discovery 1
- Range Rover Classic
- Specifications
- > Size - 16" x 7"
- > PCD - 5 x 165.1
- > Offset - et 15
- > Weight - 14.3kg



- DA2488** Anthracite
- DA2489** Black

Smart looking, tough, high quality alloy wheels which are ideal for off-road use. Used for rally-road competition vehicles as well as the military these Blindo wheels are TÜV approved and manufactured in Italy.

- > Only prime aluminium is used.
- > Less silicon is added than cheaper alloy wheels.
- > Alloys are heat-treated for improved mechanical properties.
- > Metal is de-gassed to remove any small bubbles.
- > Low pressure cast to ensure improved metal density.
- > Once made each alloy is x-rayed to check for defects, then water tank pressure tested to ensure no leaks.

DA2488



DA2489



Note - It is the responsibility of the vehicle owner to ensure that the wheels fitted to their vehicle have an appropriate load rating. The minimum required load rating can be determined by taking the manufacturers recommended maximum axle weight and dividing by two.

**MaxXtrac - Mach 5 Alloy Wheels**

DA2471



DA2472



DA2473



DA2476



DA2478

DA2474



DA2477



DA2475

- MaxXtrac Mach 5 Alloy Wheels
- Defender
  - Discovery 1
  - Range Rover Classic
  - > Size - 16" x 8
  - > Offset - et 10
  - > Load rating - 1,450kg

Engineered in UK & supplied with 5 standard wheel nuts

Wheel	Wheel Centre	
<b>DA2471</b>	<b>DA2476</b>	Satin Black
<b>DA2472</b>	<b>DA2478</b>	Anthracite
<b>DA2473</b>	<b>DA2477</b>	Silver
<b>DA2474</b>		Set of 5 spare wheel nuts
<b>DA2475</b>		Set of 5 locking wheel nuts





# WHEELS

## Wheels

### Zu Wheels

ANTHRACITE - GLOSS



ANTHRACITE - MATT



BLACK - GLOSS



BLACK - MATT



HIGH POWER SILVER



SILVER



WHITE



**Super Strong**  
**Super Light**

#### Defender/Discovery 1/Range Rover Classic 16 x 7 Rims

- > 11mm + VE offset
- > 1,400kg rating
- > 10.4kg each

DA2437	Anthracite - gloss
DA2436	Black - gloss
DA2439	Black - matt
DA2435	Silver
DA2434	White

**Note** - Wheel nuts not included

#### Discovery 2/Range Rover P38 18 x 8 Rims

- > Part number includes wheel adaptor ring
- > 36mm + VE offset
- > 1,400kg rating
- > 12.0kg each

DA2458	Anthracite - gloss
DA2459	Anthracite - matt
DA2456	Black - gloss
DA2457	Black - matt
DA2461	High Power Silver
DA2460	Silver

**Note** - Centre caps and wheel nuts not included

#### Discovery 3/Discovery 4\* Range Rover Sport - Mk1\* Range Rover L322\* 18 x 8 Rims

- > 36mm + VE offset
- > 1,400kg rating
- > 12.0kg each

DA2452	Anthracite - gloss
DA2453	Anthracite - matt
DA2450	Black - gloss
DA2451	Black - matt
DA2454	Silver

**Note** - Centre caps and wheel nuts not included

\***Note** - Zu rims will not fit any Range Rover L322 Supercharged or Range Rover Sport Supercharged fitted with Brembo brake callipers. Will only fit Discovery 4 with 2.7ltr engine.

- > Super strong
- > Super light
- > TÜV approved and meets or exceeds UK - European - U.S. - Canadian - Australian - South African and Japanese wheel manufacturing specifications
- > Uses standard Land Rover alloy wheel nuts
- > Easy to balance

**BRITPART**  
**EXCLUSIVE UK**  
**TRADE DISTRIBUTOR**



Wheel cap	Pack of 4
Discovery 2/Range Rover P38	LR094546LR Silver
	LR094547LR Black/Green



Wheel cap	Pack of 4
Discovery 3/Discovery 4	Range Rover Sport - 2005 - 2009
	Range Rover L322
LR094546LR	Silver
LR094547LR	Black/Green



*Note - It is the responsibility of the vehicle owner to ensure that the wheels fitted to their vehicle have an appropriate load rating. The minimum required load rating can be determined by taking the manufacturers recommended maximum axle weight and dividing by two.*



**Steel Wheels**



*Enhance your  
Land Rover  
with a set of  
smart new wheels.*

**Defender**

<b>ANR4583PM</b>	Wolf style - welded tubeless - use longer studs (FRC7577)	16" x 6.5J	Primed
<b>ANR4583SILVER</b>	Wolf style - welded tubeless - use longer studs (FRC7577)	16" x 6.5J	Silver
<b>VPLDW0095PVT</b>	Wolf style - welded tubeless - use longer studs (FRC7577)	16" x 6.5J	Black gloss
<b>ANR4636PM</b>	Standard - welded tubed	16" x 5.5F	Primed
<b>ANR5593PM</b>	Wolf style - welded tubed	16" x 6.5J	Primed
<b>DA3187</b>	8-spoked - welded tubeless	16" x 7	White with red & blue stripes
<b>LR053845</b>	Standard - welded tubeless - Defender - 1987 - 2016	16" x 5.5J	Primed

**Discovery 1**

<b>DA3187</b>	8-spoked - welded tubeless	16" x 7	White with red & blue stripes
<b>NTC5193PM</b>		16" x 7JH	Primed

**Freelander 1**

<b>RRC503430MUW</b>		15" x 5.5J	Silver
---------------------	--	------------	--------

**Range Rover Classic**

<b>DA3187</b>	8-spoked - welded tubeless	16" x 7	White with red & blue stripes
---------------	----------------------------	---------	-------------------------------

**Series**

<b>ANR4636PM</b>	Standard - welded tubed	16" x 5.5F	Primed
<b>DA1999G</b>	Standard - welded tubed	16" x 5.5F	Limestone (ANR4636PM)



**DA2694**  
**Large Offset**  
**Steel Wheel**  
16" x 8  
Defender  
Offset et00

A large offset steel rim to fit traditional Land-Rover axles. In the style of a 1-ton rim but 8 inches wide to fit larger modern tubeless tyres. Black primed.

*Note - It is the responsibility of the vehicle owner to ensure that the wheels fitted to their vehicle have an appropriate load rating. The minimum required load rating can be determined by taking the manufacturers recommended maximum axle weight and dividing by two.*



Photo by Jake Lloyd



**DA2694**



# WHEELS

## Wheels

### Wheel Adaptors & Spacers



#### Wheel Spacers

Improve your Land Rover's appearance, steering lock & handling with a set of wheel spacers.

Defender/Discovery 1/Range Rover Classic 30mm thick, steel machine finish complete with wheel nuts and OEM studs

**DA5004** Set of 4

**DA5004S** Single spacer

#### Wheel Adaptors

Convert your existing stud pattern to allow for fitment of a different style of wheel.

Fit Range Rover L322 or Range Rover Sport wheels to a Discovery 2 or Range Rover P38.

**DA6343** Set of 4



## Wheel Protection

### Locking Wheel Nut Kits, Keys & Caps

#### ANR6091

Freelander 1  
Kit - 5 x nuts; 1 x key; 1 x removal tool

#### ANR6094L

Freelander 1  
Locking wheel nut cap

#### DA2989

Defender drive flange bolt caps Qty 20

#### KBP10001

Freelander 1  
Wheel nut cover removal tool

#### LR078545

Discovery 3/Discovery4/Discovery 5  
Range Rover Sport - Mk1 - 2010 - 2013  
Range Rover Sport - Mk2  
Range Rover L322 - 2006 - 2009  
Range Rover L405  
Kit - 4 x nuts; 1 x key

#### LR086417G

Freelander 2/Discovery Sport/Range Rover Evoque  
Range Rover Velar  
Kit - 4 x nuts; 1 x key

#### RRB100370

Range Rover P38 with alloy wheels  
Kit - 4 x nuts; 4 x caps; 1 x key

#### RRB100510

Discovery 2 with alloy wheels  
Kit - 1 x nut; 1 x cap; 1 x key; 1 x removal tool

#### RRB100510SET

Discovery 2 with alloy wheels  
Kit - 5 x nuts; 5 x caps; 1 x key; 1 x removal tool

#### RRB500090

Defender/Discovery 1/Range Rover Classic - 1989 - 1994  
with alloy wheels  
Kit - 5 x nuts; 5 x caps; 1 x key; 1 x black bag for key  
1 x removal tool

#### RRD000100LR

Range Rover L322  
Locking wheel nut - 35

#### RRD000110LR

Range Rover L322  
Locking wheel nut - 36

#### RRD000120LR

Range Rover L322  
Locking wheel nut - 37

#### RRD000130LR

Range Rover L322  
Locking wheel nut - 38

#### RRJ000030LR

Range Rover L322  
Locking wheel nut cap



#### RRJ100120

Defender/Discovery 2/Range Rover P38  
Locking wheel nut cap

#### RTC9535

Defender/Discovery 1/Range Rover Classic - 1989 - 1994 with steel wheels  
Kit - 5 x nuts; 1 x key (black finish)

#### STC50080

Discovery 2 - Full set of wheel nuts  
Kit - 5 x locking nuts; 5 x spare caps; 18 x normal nuts (inc. caps); 1 x key; 1 x remover tool

#### STC7623LR

Defender with Deep Dish alloy wheels  
Kit - 5 x nuts; 5 x caps; 1 x key

#### STC8843AA

Defender/Discovery 1/Range Rover Classic - 1989 - 1994 with alloy wheels (not deep dish)  
Kit - 5 x nuts; 5 x caps; 1 x key



*Protect your valuable wheels & tyres*



**Locking Wheel Nut Kits, Keys & Caps**

Locking wheel nuts		Locking wheel nut keys	
Defender	Discovery 2	Defender	Discovery 1
Code A	Discovery 1	Range Rover P38	Range Rover P38
Code B	Discovery 1	Range Rover P38	Range Rover P38
Code C	Discovery 1	Range Rover P38	Range Rover P38
Code D	Discovery 1	Range Rover P38	Range Rover P38
Code E	Discovery 1	Range Rover P38	Range Rover P38
Code F	Discovery 1	Range Rover P38	Range Rover P38
Code G	Discovery 1	Range Rover P38	Range Rover P38
Code H	Discovery 1	Range Rover P38	Range Rover P38
Code I	Discovery 1	Range Rover P38	Range Rover P38
Code J	Discovery 1	Range Rover P38	Range Rover P38



Locking wheel nut keys	
Discovery 3	Discovery 4
Code A	Range Rover Sport - Mk1
Code B	Range Rover Sport - Mk1
Code C	Range Rover Sport - Mk1
Code D	Range Rover Sport - Mk1
Code E	Range Rover Sport - Mk1
Code F	Range Rover Sport - Mk1
Code G	Range Rover Sport - Mk1
Code H	Range Rover Sport - Mk1
Code J	Range Rover Sport - Mk1
Code K	Range Rover Sport - Mk1
Code L	Range Rover Sport - Mk1
Code M	Range Rover Sport - Mk1
Code N	Range Rover Sport - Mk1
Code P	Range Rover Sport - Mk1
Code R	Range Rover Sport - Mk1
Code S	Range Rover Sport - Mk1
Code T	Range Rover Sport - Mk1
Code U	Range Rover Sport - Mk1
Code V	Range Rover Sport - Mk1
Code W	Range Rover Sport - Mk1

**Bulk Wheel Nuts**

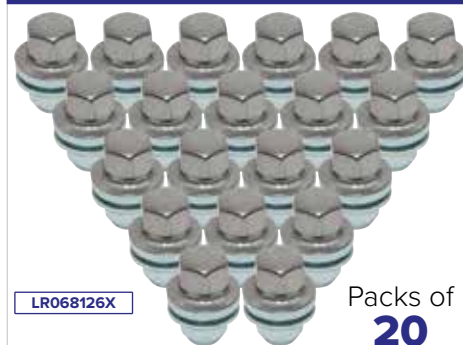

LR068126X

Packs of **20**

LR068126GX / LR173842GX	OEM	Pack of 20
LR068126X / LR173842X	NEW	Pack of 20
LR068126BX / LR173842BX	NEW Satin Black	Pack of 20
Defender - 2020 onwards		
Discovery 3		
Discovery 4		
Discovery 5		
Range Rover Sport - 2010 - 2013		
Range Rover Sport - 2014 onwards		
Range Rover L322 - 2010 - 2012		
Range Rover L405		
RRD500560GX	OEM	Pack of 20
RRD500560X		Pack of 20
RRD500560BX	OEM Satin Black	Pack of 20
Defender		
Discovery 1		
Range Rover Classic		
ANR3679X	With washer	Pack of 20
ANR3679GX	OEM - with washer	Pack of 20
Discovery 2		
Range Rover P38		
LR001381X		Pack of 20
Freelander 2		
Discovery Sport		
Range Rover Evoque Mk1 & Mk2		
Range Rover Velar		
RRD500010GX	OEM Black	Pack of 100
RRD500010X	Black	Pack of 100
Defender - 1987 - 2006 & 2007 onwards		
Discovery 1		

**Black Wheel Nuts & Locking Key Kits**

DA2548	Black locking wheel nut kit
Defender - 2020 onwards	
Discovery 3/Discovery 4/Range Rover Sport - Mk1	
Range Rover L322 - 2002 - 2009	
NRC7415B	Black single nut
Defender - 1987 - 2006/Discovery 1	
Range Rover Classic - 1986 - 1991	
RRD500560B	NEW Black single nut
RRD500560BX	NEW Pack of 20
Defender/Discovery 1/Range Rover Classic	
RRD500560GB	Black single nut
Defender/Discovery 1/Range Rover Classic	
DA3548	Black locking wheel nut kit
Defender - 2007 onwards	
Discovery 1/Range Rover Classic	
DA3428	NEW Black locking wheel nut kit
Defender - 2020 onwards	
LR068126B	Black single nut
LR173842B	NEW Black single nut
LR068126BX	NEW Pack of 20
LR173842BX	NEW Pack of 20
Defender - 2020 onwards	
Discovery 3	
Discovery 4	
Discovery 5	
Range Rover Sport - 2010 - 2013	
Range Rover Sport - 2014 onwards	
Range Rover L322 - 2010 - 2012	
Range Rover L405	



LR173842BX



Photo by Philip Saglimbene



# WHEELS

## Wheel Protection

### Spare Wheel Covers



DA2025



STC7889LR



VPLEW0143LR

Plain black, easy to fit spare wheel covers.

DA2021	75 x 16
DA2022	6.0 x 16 & 195 x 80 x 15
DA2026	205 x 16

DA2025	235 x 70 x 16 & 255 x 55 x 18
DA2027	235 x 85 x 16
STC7889LR	Defender
VPLEW0143LR	Defender 2020



DA2891



DA2892



DA2893

Suitable for Defender 2020 onwards & all rear mounted tyres - 225/70R18 / 255/65R19 / 255/60R20 / 255/70R18 / 275/45R22

Stylish cover which protects the rear wheel from the elements. Manufactured using tough, high quality materials to OEM standards. Elasticated band makes this cover an easy fit.

#### 1st Pick Cover Design

DA2891	Gloss black & silver
DA2892	Matte black & silver
DA2893	Gloss black
DA2982	Matte black

#### 2nd Pick Sticker Design

##### STICKER-COMPASS

Compass & hills design

##### STICKER-TRACK

Off-road tyre tracks design

##### STICKER-UNION-F

Union Jack design

##### STICKER-UNION-FG

Monochrome Union Jack design

##### STICKER-XS

Tyre splash & XS design

##### STICKER-COMPASS



##### STICKER-TRACK



##### STICKER-UNION-F



##### STICKER-UNION-FG



##### STICKER-XS



DA2982



DA2892 & STICKER-UNION-F

### Spare Wheel Protectors



**Easy to fit to give you piece of mind**

The valuable spare wheel on your Land Rover are very vulnerable to theft. These steel spare wheel protectors are designed to restrict access to the winching mechanism and makes it almost impossible for anyone to steal the wheel. Easy to fit to give you piece of mind.

DA1360	Discovery 3 Discovery 4 - not suitable for AdBlue models Range Rover Sport - 2005 - 2013
DA5692	Discovery 5



Photo by Jake Lloyd





Photo by Sirsendu Gayen

### Cordless Tyre Inflator Air Compressor

A rechargeable and detachable 20V high-performance battery is included along with an extra base which is powered by the 12V on-board power outlet with a 3m power cable.

The LCD display not only shows the battery level and 4 optional pressure units (PSI, BAR, KPA, Kg / cm<sup>2</sup>) but also displays the current tyre pressure and target tyre pressure. When it reaches the pre-set pressure the inflator will stop automatically.

An LED light can be controlled by an independent switch, providing bright vision at night or in dark places.

Storage of the tyre inflator is easy thanks to its compact design.

**Specification**

- > Input voltage - DC 21V
- > Operating voltage - DC 18V
- > Maximum current - <11A
- > Maximum inflation pressure - 150PSI
- > Air volume - 40L/min
- > Battery capacity: 5 x 2500mAh lithium
- > Accuracy - ±1.5psi
- > Charging time - 3-5 hours
- > Use time - 30min
- > LED light - 8LM
- > Length of hose - 350mm
- > Length of power cord (no battery packaging) - 3m±10mm
- > Working environment temp - -20° to 50°
- > Weight - 2.03kg

**XS Cordless Tyre Inflator Air Compressor**

**DA2908 NEW** With UK Plug

**DA2908EU NEW** With EU Plug

20V cordless tyre inflator air compressor up to 150PSI with LCD digital pressure gauge, LED light, rechargeable li-ion battery and 12V socket.

A fully charged 20V tyre inflator can top up 10 car tyres (185/70 R14). Extra nozzles included can also easily inflate bicycles, motorcycles, SUVs, vans, along with inflatable toys and balls. It has increased power with air flow up to 40L/min. It only takes 2 minutes to fill up an empty 185/70 R14 tyre.

*When it reaches the pre-set pressure the inflator will stop automatically.*

**Kit Contents**

- 1 x Tyre inflator
- 1 x Cigarette lighter socket
- 1 x Lithium battery holder
- 2 x Conical nozzle
- 1 x Transfer valve
- 1 x Air hose
- 1 x Ball needle
- 1 x Portable zipper bag
- 1 x User manual





# WHEELS

## Tyre Maintenance & Tools

### Valve Caps



Enhance your wheels with a set of 4 smart valve caps.  
**LR027664** Union Jack design with silver outer  
**VPLRW0153G** Black Union Jack design with silver outer  
**DA1436** Chequered flag design with silver outer  
**DA1437** Chequered flag design with black outer



**ARB Valve Caps**  
 Pack of 5. Manufactured from durable anodised aluminium. UK only.  
**217090** Silver

### Inner Tubes



**DA3000**  
 7.50 x 16 - Uses TR15 (large) type valve  
**DA3201**  
 205 x 16 - Uses TR13 (small) type valve

### Stud Klean

**DA1698**  
 The all-in-one stud & hub cleaning tool!  
 Stud Klean attaches firmly to a standard impact wrench, providing the fastest and safest cleaning solution for your wheel changing process. The face of the tool moves rust and contaminants in seconds, providing a smooth clean surface for ease of assembly of all mating parts. At the same time, stainless steel tines effectively clean the threaded studs assuring easy and accurate torquing of lug nuts. The proprietary abrasive material is significantly longer lasting than any other material on the market.

- > Cleans the hub and stud at the same time
- > Fits to 1/2" impact
- > Single size for all passenger cars and light trucks
- > Won't damage your wheels
- > Dense, long lasting abrasive pad
- > Hundreds of internal stainless steel tines instantly & effectively clean threaded studs
- > Stack tolerances when balancing wheels will improve and ensure proper torque tensioning during installation
- > Cleans approximately 800 wheels



### Speedo Heater



**DA1426**  
 Defender  
 Td5 & 2007 onwards  
 Plug & play. Behind the handbrake backplate, on later Defenders, is a green 3 wire transducer which generates a pulse. This is then sent to the speedometer to show your vehicle's speed. Fitting different sized tyres or a non-standard ratio ring and pinion in the diffs could well mean the speed displayed is inaccurate. Fitting and programming this small box is easy. Once installed it allows you to adjust the output pulse, both up and down, which means your speedo will indicate the correct speed at which you are travelling.

### Wheel Wrenches

**537179** Wrench size - 15/16"  
**DA4026** Wrench size - 27mm  
**NTC7829** Wrench size - 27mm  
**NTC7829HD** Wrench size - 27mm - heavy-duty  
**LR011870** Wrench size - 27mm  
**LR011870HD** Wrench size - 27mm - heavy-duty



### Tyre Repair Kits



**DA2390**  
**Tyre Repair\* Kit in Travel Case**  
*How It Works*

1. Find and remove the item that caused the puncture.
2. Apply rubber solution to the reamer tool then push the reamer into the puncture and work up and down until the reamer moves easily in the hole.
3. Thread one rubber tyre plug in the hook tool.
4. Push the rubber tyre plug into the hole until 1/2" of the tyre plug remains outside the tyre then turn the hook tool a quarter turn and pull out slowly.
5. Cut off the excess tyre plug as close to the tyre as possible.
6. If the puncture is too big have the tyre fixed by a professional.

\*Recommended for off-road use only.  
**ARB Speedy Seal Kit**  
**DA8930** ARB Speedy Seal puncture repair kit  
**10100010** ARB Speedy Seal replacement cords x 50  
 Full details in ARB Compressor & Tyre Maintenance Section

### Air Compressors



*Handy to keep in your Land Rover*



*It's no good being able to repair your tyres if you can't inflate them. Full details of these air compressors can be found in the Off-Road section.*

**DA2392XS**  
 Double-pump air compressor  
 Air flow - 150ltr/min

**DA2354XS**  
 Single-pump air compressor  
 Air flow - 72ltr/min

**DA5078**  
 Ring Rapid digital air compressor

*Don't get caught out with a flat tyre or two!*

**DA1890**  
**Replacement Tyre Sealant & Hose Kit**  
 Equivalent to  
 LR072362 - 450ml sealant  
 LR016392 - adaptor hose  
 Freelander 2 - from EH384095  
 Range Rover Evoque - 2012 - from FH017663  
 Range Rover Evoque - 2019 onwards  
 Range Rover - L405 - from EA157922  
 Range Rover Sport - Mk2 - from EA348512  
 Range Rover Velar  
 Discovery Sport - from FH501420  
 Discovery 5



**Magnum High-Precision Tyre Balancing Beads**

**What are MAGNUM+ Beads & How Do They Work?**

Beads are dispersed evenly around the inner wall of the tyre through centrifugal force. Based on Newton's law that every force creates an equal and opposite reaction, MAGNUM+ beads reposition themselves to offset the heavy spots, neutralizing the imbalance and eliminating vibration. Made of tempered glass, MAGNUM+ beads are 98% round and carefully calibrated for consistent size and maximum precision.

- > 100% TPMS (Tyre pressure monitoring system) compatible
- > No special valve core required
- > Perfectly round and extremely smooth preventing them from disintegrating and causing any damage to the inner liner of the tyre.



See them work here

[www.britpart.com/magnum-action](http://www.britpart.com/magnum-action)

**MAGNUM+ Benefits**

**Save Fuel**

High precision balancing means a proper, consistent balance every time. A balanced tyre means less vibration resulting in a reduction in rolling resistance, and in turn, better fuel efficiency!

**Save Time**

Self-adjusting balancing minimizes downtime on the job and less time in the workshop so you can do more... and play more.

**Save Money**

Saving fuel and time ultimately means that you save money. MAGNUM+ will extend the life of your tyres by promoting consistent, even wear and tear. With MAGNUM+ you will replace your tyres less often!

**Balance It. Forget It.**

Proper tyre maintenance involves a constant balancing that will, on one hand, maintain fuel efficiency and, on the other hand, maximize the life of the tyre. Traditional external weight tyre balancing means rebalancing your tyres at regular intervals. With MAGNUM+, all tyres can be efficiently balanced throughout their life because the beads retain their physical characteristics and never disintegrate, thus they will outlast your tyres.

**Adapt To Any Road Condition**

If you like to play in the mud, drive in the snow or go from one messy job site to another, heavy spots on your tyre may change leaving your wheels unbalanced. Wheel weight balancing can often be ineffective on a vehicle experiencing various conditions. With MAGNUM+ the beads simply reposition themselves according to the new force created by the heavy spot.

**Using MAGNUM+ Beads**

**Toss**

First, you need to determine what size MAGNUM+ you require using the online calculator. MAGNUM+ comes in pre-measured INSERT™ bags that you simply toss directly inside the tyre during installation. That's it! The rest is business as usual.

**Online Bead Requirement Calculator**

[www.britpart.com/magnum](http://www.britpart.com/magnum)

**Mount**

You don't have to do anything to the bag. Once you toss the MAGNUM+ insert bag into the tyre, just mount the tyre to the rim as normal!

**Inflate**

When you're ready, inflate the tyres as usual. There's nothing else to do. No spinning, waiting, calibrating or weight fixing. The whole process takes a fraction of the time as a traditional fixed weight balance!

**Drive**

Then get on the road! As you drive, the bag will break open and set the beads free to do their job, providing a high-precision balance every time!



Ideal for off-road use

[www.britpart.com/magnum-offroad](http://www.britpart.com/magnum-offroad)



DA5220



**Bulk**

**DA5220 NEW** Loose bead tub with measuring scoop 8 kg

**Cases**

Individually packaged bags containing the toss-in insert bag

**DA5221 NEW** LTP100 - 85g 36 bags

**DA5222 NEW** LTP150 - 128g 36 bags

**DA5223 NEW** LTP200 - 185g 24 bags

DA5222



**magnum**

**BRITPART**

Exclusive UK Stockist in the 4x4 Market



**Bottle Jack**



**ANR4489**

Bottle jack kit (LR031924 & KAH000060)

**LR031924**

Bottle jack

**KAH000060G**

Handle for bottle jack (LR031924)



Photo by Andy Foster



### ARB Air Compressors & Tyre Maintenance



More information online

#### DA1441

##### ARB Digital Inflator

- > Corrosion resistant die-cast body
- > Rubber bump guard to protect against drops and knocks
- > Large LCD digital readout with blue backlight
- > Multiple measurements
- > Pressure sensing auto wake up display
- > Battery level indicator
- > Precision clip on connector
- > Air bleed button for accurate pressure adjustment
- > Extended stainless steel braided kink resistant hose with PVC sheath and dual swivel joints for use at any angle
- > Coated thumb trigger
- > Up to 200 hours runtime on set of batteries



#### ARB605A

##### ARB Tyre Inflator

- > Compatible with ARB compressors
- > Protective rubber gauge guard
- > Air bleed button for deflating
- > 600mm stainless braided PVC coated flexible hose
- > Clip on chuck
- > Incorporates 1/4" NPT-US industrial interchange male coupling
- > Bronze bourdon tube gauge design
- > Fully gear, solid brass precision movement
- > Easy to read dial with psi & bar scales



#### DA8931

##### ARB E-Z tyre Deflator

- The unique, patented design of the E-Z Deflator allows for removal of the valve core for rapid tyre deflation, while also providing accurate pressure reading via the simple movement of a sliding valve. Provided in a protective canvas pouch, the quality bronze Bourdon Tube gauge design ensures accuracy is not affected by fluctuations in temperature, humidity or altitude.
- > Corrosion resistant brass/stainless deflator tool
  - > Fully geared, solid brass precision movement
  - > Protective rubber gauge guard
  - > Easy to read dial with one PSI increments



#### ARB510

##### ARB E-Z Deflator Digital Gauge

- The ARB E-Z Deflator Digital Gauge makes tyre deflation even easier thanks to accuracy of up to +/-1psi @ 15-75psi, a large digital read out with blue backlight display as well as multiple pressure readouts including PSI, BAR, KPA and KgF.
- > Ribbed rubber gauge guard
  - > Flexible braided hose
  - > Full swivel gauge connection
  - > Rated capacity - 0 to 200psi
  - > Multiple pressure scales
  - > Large LCD digital readout
  - > Easy read blue backlight display
  - > Brass components and crimps
  - > Up to 200hrs battery life



#### DA8998

##### ARB Portable Air Compressor

This portable 12V air compressor comes in a durable polypropylene carry case for added versatility and uses quality components for quiet operation and extra long life. Including a 19ft air hose, it also comes with all the necessary fittings for tire inflation and camping or leisure gear. Its twin motors are internally thermal protected against extreme temperature damage while a heavy duty in-line maxi fuse for each motor provides professional circuit protection. The compressor comes in a high quality carry case featuring internal pockets for components and accessories including a 6 metre air hose. Much more information available online.



#### DA6823

##### ARB Twin Portable Air Compressor

Designed to fill the market need for a compact sized yet high performance compressed air source for rapid inflation of large tyres as well as the high volume air needs of most air powered tools. The ARB compressor is a world class recreational product designed and built to commercial/industrial standards to survive harsh and demanding outback conditions. Much more information available online.



#### DA4985

##### ARB Twin On-board Compressor Kit

Designed to fill the market need for a compact sized yet high-volume compressed air source to suit the high volume airflow needs of most air powered tools, and also to suit the actuation and control needs of the ARB Air Locker, and the harsh and demanding environment of the ARB Air Locker user. Much more information available online.



#### DA6253

##### ARB Tyre Inflation Kit

The ARB tyre inflation kit for air compressors is specially sourced from Japan, providing a unique high-heat tolerant hose for the hi-output compressor (DA4190). The practical kit includes a dust resistant air chuck and an enclosed internal bearing system to prevent dirt ingestion.

- > Suitable for camping, touring and off-road applications as well as everyday usage
- > Provides fast, accurate inflation
- > Kit includes
  - 1 x high heat pressure hose
  - 1 x ARB air chuck with quick press fitting
  - 1 x ARB T-fitting for use with the ARB air compressor (DA4190) and an assortment of additional fittings to suit various camping and sporting gear such as air mattresses and footballs



#### ARB Speedy Seal Puncture Repair Kit

##### DA8930 Repair kit

Coming in a compact, high visibility carry case, the Speedy Seal includes all the components necessary to repair tubeless radial or cross ply tyres, without removing the tyre from the vehicle or rim. A pencil type tyre gauge with dual chuck makes setting pressures a snap, while a spring steel insertion needle and hardened reamer tool allow fast tyre repairs.

- > Lubricant for easier tool insertion
- > Additional accessories (valve core tool, spare valves and valve caps)
- > 30 self vulcanising repair cords for complete air sealing
- > Allen keys



#### 0740113 NEW

##### ARB Hose Coupling Dust Cap

#### DA6824

##### ARB Compressed Air Blow Gun

To keep your air compressor and air accessories clean from dust and debris encountered during regular off-road driving, the compressor blow gun is the ideal solution delivering compressed air for fast and easy cleaning.



#### DA6842

##### ARB Inflation Case

Designed to keep all your ARB air accessories secure in the one bag and easy to reach. Six specialised pockets to house ARB Inflation, ARB Deflation, ARB Gauges, ARB Hoses and other general air accessories. Externally, ARB's bright orange design insures the case itself will not get lost within the back of your vehicle. It has been manufactured to incorporate the highest of quality materials including an abrasion resistant canvas. For ease of use, a large durable rubber handle can be used to carry the case and a high-vis reflective tapping appears on the outside of the case for safety.

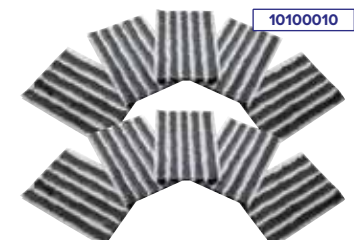

10100010



### 4X4 ACCESSORIES

ARB products available in the UK only.

#### ARB4297 NEW

##### ARB Inflation Case

Housing your Air Systems gear in a safe and convenient location within your vehicle is not always an easy task. The extreme conditions we put our vehicles through demand a solution that is fit for purpose and of the highest quality. This is the solution.

- > 7 pockets capable of holding 2 x air hoses, 1 x inflator, 1 x deflator, 1 x compressor blow gun and more
- > PVC waterproof and abrasion resistant material
- > Reflective strips for high visibility and safety
- > Holds an ARB Speedy Seal SII Repair Kit
- > Updated Air Systems branding and colours
- > Ergonomic pull ring zippers and rubber handle

Excludes contents shown



**ARB Air Compressors & Tyre Maintenance**

**0830001**

**ARB Pressure Control**

Employing the same unmatched ARB proprietary technology and learnings from over 3 years of in-field use, this premium product now provides more ARB Air Compressor customers with the option to use convenient, accurate and unmatched air pressure control. More so, this incredible functionality is conveniently controlled at your fingertips by a smartphone app!

**Features & Benefits**

- > Utilises a smartphone app and pressure control regulator valve to conveniently inflate and deflate tyres, balls, air mattresses, bike tyres and more
- > View the current pressure in your tyres
- > Set the desired target pressure using four customisable pre-set modes of your choice
- > Set the maximum system pressure
- > Choose your own units of measurement from kPa, bar, psi
- > Receive audible and vibration alerts to indicate when desired pressure has been achieved
- > Set system settings such as only allowing pressure control to operate if the engine is running
- > Initiate a recalibration of the pressure sensor via the app for unmatched accuracy
- > View the current voltage of your electrical system
- > IP rated pressure control module and wiring harness safe for engine bay mounting

**What's In The Kit**

- > Pressure control module
- > Pressure regulating valve
- > Pressure transducer
- > Wiring harness
- > Mounting bracket
- > Installation instructions

**Compatibility**

- > Suits ARB air compressors: CKSA12, CKMA12, CKMTA12
- > Suits 12-volt electrical charging systems only
- > Smartphone application suits Android and iOS compatible devices



Mobile Device Not Included



**4X4 ACCESSORIES**

ARB products available in the UK only.

**Spare Wheel Carriers**



**DA2232**  
Defender - all models/Series  
Swing away rear door mount

- DA2232BUSH NEW**  
Replacement bushes for DA2232
- DA2232P NEW**  
Replacement piston for DA2232

**DA2232BUSH**



**DA2274**

**DA2274CABLE**

**DA2274**  
Defender - with half door tailgate  
Swing away rear door mount

**DA2274CABLE**  
Spare cable for DA2274

**DA2215**  
Defender/Series  
Fixed rear door mount

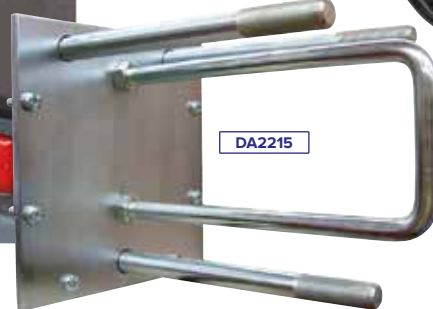

**DA2215**



**345510**  
Series/Military  
Replacement strap for  
fixing your spare wheel to  
the bonnet.

**DA2232P**

**345510**



Photo by Heather Matthews





# Make Your Land Rover A Star!

Details on how to enter and full terms and conditions - [www.britpart.com/calendar](http://www.britpart.com/calendar)

Here at Britpart we are planning our next Land Rover themed calendar and we'd love to feature the pictures of proud Land Rover owner's vehicles - whatever model, age or condition of the vehicle.

12 x Prizes Available

We love to see pictures of Land Rovers in locations stretching from rural UK, right through to vehicles in a foreign urban environment - use your imagination.

Winning entries will all feature in the next Britpart calendar and each one picked will win a great prize. So get out there with your Land Rover and camera - happy snapping. You can send us as many entries as you would like! **Good luck!**



[www.britpart.com/calendar](http://www.britpart.com/calendar)

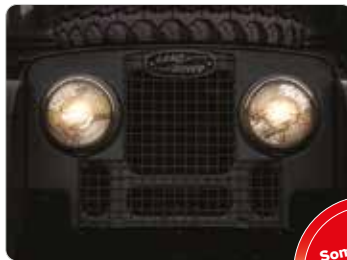



# LIGHTING



Light Up The  
Way Ahead



### Driving Lights



DA4088



PRC8238



DA6502

DA6503

DA4088W



DA4088

DA4099



STC8480LR



#### 8" Driving Lights

- > 100 watt
- > Universal fitting
- > High power halogen lights
- > Fits all 12 volt vehicles
- > Easy installation
- > Armoured cable
- > Fitted plastic stone guards
- > Excludes wiring kit

<b>DA4088</b>	8" Light	Black	Pair
<b>DA4088C</b>	8" Light	Chrome	Pair
<b>DA4088W</b>	Wipac 8" Light	Black	Pair

#### DA4088BULB

Replacement 100 watt bulb for DA4088; DA4088C & DA4088W

#### DA4088COVER

Replacement cover for DA4088; DA4088C & DA4088W

#### Cibi Driving Light

- DA6502** Cibi LED spot light - single
- High performance with a large, homogeneous beam
- > Includes one Oscar LED light with wiring, mounting hardware, installation instructions, white protective cover with Cibi logo and Cibi sticker.
  - > Coated polycarbonate lens is waterproof, shock resistant, corrosion resistant and UV resistant.
  - > Luminous flux - 700lm
  - > Voltage - 12 - 24V DC
  - > Light temperature - 6,000K
  - > Candelas - 75,000 cd
  - > Length of visibility - 370m
  - > Width of visibility - 40m
  - > Safety certification - ECE/SAE/CCC

<b>DA6503</b>	Replacement Cibi cover	Pair
---------------	------------------------	------

#### Other Driving Lights

<b>DA4099</b>	Hella Rallye 3000	Black	Single
<b>PRC8238</b>	Spoiler lights classic	Black	Pair
<b>STC8480LR</b>	Safari 5000	Black	Single

Defender - 1987 - 2006/Discovery 1/Discovery 2  
Range Rover Classic - 1992 - 1994/Range Rover P38

### Light Bar

#### STC50243

Discovery 2

Black

**Note** - Excludes lights



### Universal Drive/Spot Light Harness Assembly



DA6619

Ideal for installing Britpart's XS Lynx auxiliary lights.

### Fog Lights



STC7643



RTC8922

#### RTC8922

Defender - up to 2006  
Range Rover Classic  
Hella Comet 550 - Rectangular  
Black  
Pair

**Note** - 195 W x 96 H x 83mm D

#### STC7643

Defender - up to 2006/Discovery 1/Discovery 2  
Hella Rallye 1000 - Round  
Black  
Single

#### LR004088

Freelander 2 - up to AH999999  
Upgrade your Freelander 2 with this genuine driving and fog light upgrade kit. Adds driving lights to Freelander 2 models with fog lights, giving you better all-round night vision. The kit comes with everything you need to upgrade to driving lights (vehicle must have bumper fog lights already fitted).

LR004088



**XS Lynx Auxiliary Lights**

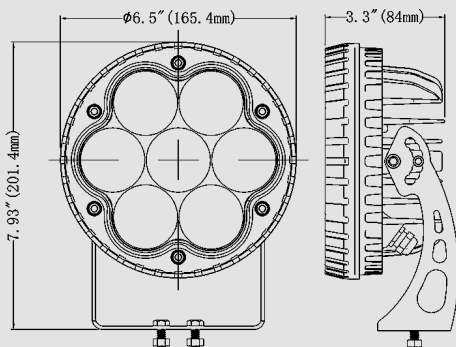

*Unbreakable optical polycarbonate lens*

*Completely waterproof & dustproof*



These still images don't do justice to what a massive difference the XS Lynx Spot Lights make. Check out our video showing them in action.

[www.britpart.com/wow](http://www.britpart.com/wow)

DA6618 - Flood/Combo Light Spread

DA6633 - Spot Light Spread

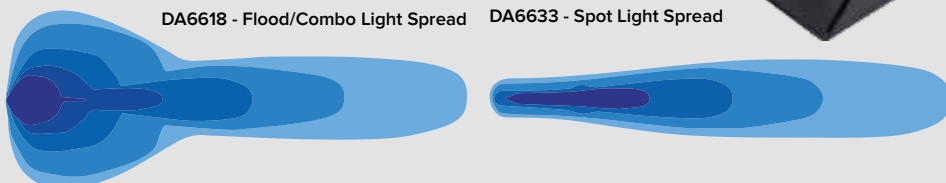

# XS Lynx Auxiliary Light



DA6618	Flood/Combo light	Single
DA6633	Spot light	Single
DA6619	Universal drive/spot light harness assembly	

- > 7 x 10W CREE LEDs
- > 70 watts
- > 11,000 lumens
- > 9 - 32V
- > 6 amps
- > Shockproof
- > Die cast aluminium housing
- > UV polyester powder coated - won't fade in the sun
- > Unbreakable optical polycarbonate lens
- > Stainless steel bracket and accessories
- > IP68 certified - completely waterproof & dustproof
- > RFI/EMC protected - won't interfere with radio reception
- > Deutsch connectors - for easy wiring
- > Pressure equalizing vent
- > 50,000 hour lifespan
- > Over & under voltage protection
- > Operating temperature: -60°C to 125°C
- > CE & RoHs compliant



**Roo-Lites**



**DA1062 Roo-Lite**

- > High performance lighting with super strength construction
  - > 7¼" round long range spot lights with "stone-proof" clear polycarbonate lens
  - > Super strength housing with an Osram 100 watt Xenophot long life technology bulb
  - > Variable focus from spot to fog beam pattern
  - > Lightweight for reduced vibration
  - > Reflector unit is screw-on for easy bulb change
  - > 12V - 100W - 8 amps
- Note** - Roo-lites sold individually

**ROO-LITE®**



**Roo-Lite Impact Resistant Covers Plain**

DA1062AMBER	Amber
DA1062BLUE	Blue - produces 'Xtra white' light
<i>Diffused</i> - suitable for fog/snow conditions	
DA1062FOGA	Amber
DA1062FOGW	Blue - produces 'Xtra white' light
DA1062COVER	Protective cover
<b>Note</b> - Roo-Lite covers sold individually	
DA1063	100W Spare bulb
DA1064	Harness

Harness is of a heavy gauge wire to ensure safe operation of high wattage lights. It includes digital switch, in-line fuse, built-in relay and wiring harness.

*Exclusive to Britpart*

*High performance lighting with super strength construction*





### LED Lights

#### DA3293 NEW

##### 240W Single LED Light Bar

- > 48 x 5W CREE LEDs
- > ECE /SAE high beam combo pattern
- > Die-cast aluminium alloy housing and polycarbonate cover
- > Adjustable side brackets
- > Stainless steel fixings
- > Lumens: Raw - 16,800 Lms  
Effect - 10,900 Lms
- > Angle: 20° to 60°

- > Power: 240W
- > Voltage: 10-32V DC
- > Colour temperature: 6,000K
- > Waterproof: IP68
- > Size: 1299 x 85 x 63mm
- > Lifetime: More than 30,000 hours
- > Certification: CE ROHS IP68 ECE R112



#### DA3287 NEW

##### 120W Dual Row LED Light Bar

- > 40 x 3W Osram LEDs
- > ECE /SAE high beam combo pattern
- > Die-cast aluminium alloy housing and polycarbonate cover
- > Adjustable side brackets
- > Stainless steel fixings
- > Lumens: Raw - 9,600 Lms  
Effect - 6,800 Lms
- > Angle: 40° to 60°
- > Power: 120W
- > Voltage: 10-32V DC
- > Colour temperature: 6,000K
- > Waterproof: IP67
- > Size: 570 x 84 x 83mm
- > Lifetime: More than 30,000 hours
- > Certification: CE ROHS IP67 ECE R112



Extra brackets  
in kit to mount  
these lights  
individually

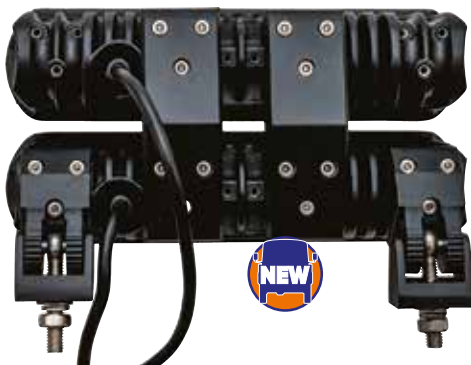

#### DA3295 NEW

##### Double 40W LED Driving Light Bars

- > 4 x 10W CREE LEDs per light
- > Deutsch connector, harness & stack brackets
- > ECE /SAE high beam pattern
- > Die-cast aluminium alloy housing and polycarbonate lens
- > Chrome reflector
- > Adjustable brackets
- > Waterproof breather screw
- > Stainless steel fixings

- > Lumens: Raw - 4,800 Lms  
Effect - 3,900 Lms
- > Power: 40W
- > Voltage: 9 - 32V DC
- > Colour temperature: 6,000 - 6,500K
- > Work temperature: -40° to 80°
- > Waterproof: IP67
- > Size: 222 x 55 x 100mm
- > Lifetime: More than 30,000 hours
- > Certification: CE ROHS IP67 ECE R112 / R10 EMC



#### DA3294 NEW

##### Single 40W LED Driving Light Bar

- > 4 x 10W CREE LEDs
- > Deutsch connector
- > ECE /SAE high beam pattern
- > Die-cast aluminium alloy housing and polycarbonate lens
- > Chrome reflector
- > Adjustable brackets
- > Waterproof breather screw
- > Stainless steel fixings

- > Lumens: Raw - 2,400 Lms  
Effect - 1,950 Lms
- > Power: 40W
- > Voltage: 9 - 32V DC
- > Colour temperature: 6,000 - 6,500K
- > Work temperature: -40° to 80°
- > Waterproof: IP67
- > Size: 222 x 55 x 100mm
- > Lifetime: More than 30,000 hours
- > Certification: CE ROHS IP67 ECE R112 / R10 EMC



#### DA3286 NEW

##### 36W Dual Row LED Light Bar

- > 12 x 3W Osram LEDs
- > ECE /SAE high beam combo pattern
- > Die-cast aluminium alloy housing and polycarbonate cover
- > Adjustable side brackets
- > Stainless steel fixings
- > Lumens: Raw - 2,800 Lms  
Effect - 2,100 Lms
- > Angle: 40° to 60°
- > Power: 36W
- > Voltage: 10-32V DC
- > Colour temperature: 6,000 - 6500K
- > Waterproof: IP67
- > Size: 213 x 84 x 83mm
- > Lifetime: More than 30,000 hours
- > Certification: CE ROHS IP67 ECE R112



**LED Lights**



**DA3347 NEW**

**24W LED Flood Light**

- > Power: 24 x 1W Osram LED
- > Effect Lumens: 1,920 LM
- > Beam pattern: Flood
- > Voltage: 9 - 32V DC
- > Colour Temperature: 6,000K
- > Body: 148,5 x 40mm
- > Waterproof & Dustproof: IP68 IP67
- > Lifespan: 50,000 hours
- > Housing: Die-cast aluminium with polyester powder coating
- > Lens: Durable polycarbonate
- > Hardware: Stainless steel
- > Operating temperature: -40°C to 85°C
- > Protection: Overvoltage and heating
- > Certificates: E-mark approved/CE/RoHs/UKCA
- > EMC Standard: CISPR25/Class 3



**DA3348 NEW**

**32W LED Flood Light**

- > Power: 32 x 1W Osram LED
- > Effect Lumens: 2,560 LM
- > Beam pattern: Flood
- > Voltage: 9 - 32V
- > Colour Temperature: 6,000K
- > Body: 111 x 61mm
- > Waterproof & Dustproof: IP67
- > Lifespan: 50,000 hours
- > Housing: Die-cast aluminium with polyester powder coating
- > Lens: Durable polycarbonate
- > Hardware: Stainless steel
- > Operating temperature: -40°C to 85°C
- > Protection: Overvoltage and heating
- > Certificates: E-mark approved/CE/RoHs/UKCA
- > EMC Standard: CISPR25/Class 3



**DA3349 NEW**

**60W LED Interior/Exterior Scene Light - Amber/White**

- > Power: 60W in total
- > Amber light: 30 x 1W Osram LED  
Effect Lumens: 2,100 LM
- > White light: 30 x 1W Osram LED  
Effect Lumens: 2,400 LM
- > Beam pattern: Flood
- > Voltage: 9 - 32V
- > Surface mounting: 45 degree tilt
- > Body: 329 x 66 x 51mm
- > Waterproof & Dustproof: IP67
- > Lifespan: 50,000 hours
- > Housing: Die-cast aluminium
- > Lens: Durable polycarbonate
- > Hardware: Stainless steel
- > Certificates: ECE/CE/RoHs/UKCA
- > EMC Standard: CISPR25, Class 3



Photo by John Walton



### Lazer Spot Lights & Grille Integration Kits

DA2843



DA2843

#### Lazer Triple-R 28 - Single light

The Triple-R light bar range brings motorsport and world rally performance to the off-road market. At 51", the Triple-R 28 is Lazer's biggest and most powerful LED lighting system which when used for night-time and low-light off-road driving and recreation, delivers an unrivalled level of long-range illumination. Tuned for a spot beam pattern, while still achieving a decent spread of light in the mid-long range, the Triple-R 28 comprises 28 high power LEDs producing 28,700 lumens at only 315 watts. The light delivers 1 lux at a staggering distance of 1273m.

- > Ultra long range optics
- > High output LED's from world leader in LED technology
- > Dynamic Drive Modulation optimises light output at all times considering thermal conditions of the light
- > 'Unbreakable' polycarbonate lens
- > Supplied with vehicle wiring kit, both side brackets and sliding centre mounts

Much more information available online at [www.britpart.com/lazer](http://www.britpart.com/lazer)

Voltage Range	10V - 32V
Raw Lumens	28560
Beam Pattern	Spot
Colour temperature	5,000K
Beam Distance (0.25LX)	2,506m
High Power LEDs	28
Power Consumption	326 Watts
Current Draw	22.6 Amps
LED Life	50,000 Hours
Weight	4.78kg



DA2841

#### Lazer ST4 Evolution - Single light

The Lazer ST4 Evolution is a hugely versatile LED spotlight the size of which has proved particularly popular within the 4x4 market. At 204mm length, the ST4 delivers incredible lighting performance which belies its diminutive size. Upgraded high-density 11W LEDs are carefully selected for their high 'bin' rating, and deliver 4,136 lumens, harnessed into a 'Drive' beam pattern optimised for lower speed applications where the priority is for good all-round visibility, albeit still with enviable distance illumination - 1 lux is achieved at 278m.

- > 4 x high density 11W LEDs (premium 'bin')
- > Seamless, low profile design facilitates installation
- > Dynamic drive modulation optimises light output to maximise LED lifetime
- > Ultra-reflective optics deliver 'Drive' beam pattern
- > E-coat pre-treatment provides maximum corrosion resistance

Voltage Range	10V - 32V
Raw Lumens	4,136
Beam Pattern	Drive
Beam Distance (0.25LX)	555m
High Power LEDs	4
Power Consumption	47 Watts
Current Draw	3.3 Amps
LED Life	50,000 Hours
Weight	670g

DA2842

#### Lazer Triple-R 4 - Single light

The Lazer Triple-R 4 offers incredible performance from a compact and great value unit. Utilising the same Boost optics as the other lights in the Triple-R range. It's unique styling and E-mark approval mean it is perfect for road, rally and race applications.

- > Ultra long-range optics
- > High output LED's from world leader in LED technology
- > CAE optimised heat-sink
- > Electronic thermal management
- > 'Unbreakable' polycarbonate lens
- > Innovative design and unique styling

E-mark Ref	275
Voltage Range	9V - 32V
Raw Lumens	4100
Beam Pattern	Spot
Optical Efficiency	92%
Beam Distance (0.25LX)	865m
High Power LEDs	4
Power Consumption	45 Watts
Current Draw	3.1 Amps
LED Life	50,000 Hours
Weight	780g

Much more information available online at [www.britpart.com/lazer](http://www.britpart.com/lazer)

DA2844



DA2844

#### Lazer Two-Light Wiring Kit (Low Power, 12V)

The ideal solution for wiring a pair of E-mark approved Lazer high performance LED spotlights. The setup is quick, easy, and reliable with 2-pin superseal connections and no configuration procedures. The kit features a 12V relay (in waterproof housing), 35A fuse, a battery terminal at one end, and 1.2m of flex on both light cables, and allows for the operation of Lazer products either in parallel with the standard lighting on the vehicle, and/or via an independent switch which can be mounted inside your vehicle. All Lazer lights are sold with a pre-wired female connector attached to the male connector of the light harness, to facilitate wiring in to your vehicle system.

- > Two-Light Wiring Kit for Lazer E-mark approved driving lights
- > 1.2m cable lengths
- > Includes 12V relay and 35 amp fuse
- > Superseal connections
- > Includes optional on/off switch for independent operation of high beam
- > Braided cable sections for added protection in engine bay

DA2859





**Lazer Spot Lights & Grille Integration Kits**



**Grille Integration Kits**

For an OE quality, fully road-legal, auxiliary spotlight installation, the Lazer grille integration kits include bespoke mounting brackets which allow for quick and easy fitting of Lazer LED spotlights within the front grille. Designed to blend seamlessly within the original styling of each vehicle, the resulting lighting setup remains fully robust and secure, with extra protection against theft. The kits include a pair of spotlights, two-light wiring kit, 4 x brackets precision-engineered to engage perfectly with the standard centre grille on the vehicle, with added strength and security provided by the supplied self-tapping (plastic) screws. Made from ASA material, known for its excellent strength and UV stability, the brackets are fully weather and chemical resistant to ensure your installation remains in great condition year after year. Supplied alongside the mounting brackets are a set of cutting guides, designed to facilitate the installation and ensure a perfect fit every time, without removal of the vehicle's grille or bumper parts. Made in Britain with a 5-year warranty.



**DA2847**  
Triple-R 750 LED Spotlights Grille Integration Kit  
Discovery 4 - Up to 2014



**DA2846**  
Triple-R 750 LED Spotlights Grille Integration Kit  
Discovery 4 - 2014 onwards



**DA3236 Defender Roof Mounting Kit** Defender - up to 2016

Stainless steel brackets that fix to the roof side gutter. Optimised for Triple-R 28 spotlight - DA2843. Manufactured from 3mm A2 stainless steel and finished with a UV-stable, satin black powder coat. Brackets are fully corrosion resistant in line with automotive grade quality standards, as are the supplied countersunk anti-theft fasteners, which come in a variety of lengths from 20 - 80mm. To complete the mounting of different length light bars, cylindrical carbon spacers, of varying lengths, are provided to aid positioning. Installation of the brackets is completed using M6 fasteners fixed within the gutter location. Cable grommets are supplied to ensure a tidy, and sealed cable entry point. Electrical butt connectors are provided to help assure the integrity of the cable reattachment once thread through the roof. Manufactured in the UK.



**DA2845**  
ST4 Evolution LED Spotlights Grille Integration Kit  
Discovery 5



**DA2859**  
Triple-R 750 LED Spotlights Grille Integration Kit  
Defender - 2020 onwards

**DA2885 Lazer CAN Interface (Dual-Output)**

The Lazer CAN bus Interface provides an effective solution for detecting both High Beam and Side/Position Light activity, where it is not possible to detect a 12v signal at the back of the standard headlights.

The interface, developed in partnership with UK manufacturer CanM8, can identify both High Beam and Side/Position Light outputs, making it the perfect solution for all Lazer E-mark approved LED spotlights. Each interface comes supplied with a dedicated wiring kit for simplified installation, as well as compatibility with our Contactless Reader which avoids the need for metal-to-metal connection to the vehicle's CAN-Hi and CAN-Lo wires.

The interface incorporates a multi-function miniature status LED, which indicates correct connection to the CAN system, CAN activity present and confirmation that the CAN identity has been recognised.

Purchase of the Lazer CAN bus Interface will permit access to vehicle specific installation guides, available to download from the CanM8 Connect app.

**Product Features**

- > CAN bus interface provides an effective solution for detecting vehicle lighting activity
- > High beam and side/position light outputs
- > Supplied with dedicated wiring kit
- > Vehicle specific install guides available via CanM8 app
- > Compatible with Lazer Contactless Reader

**DA2885**



**DA2884**

**DA2884**

**Lazer CAN Contactless Reader**

The Lazer Contactless Reader allows for reading the CAN-Hi and CAN-Lo vehicle data without any actual metal to metal connection between the interface and the vehicle CAN wiring. The reader is secured around a section of the vehicle CAN Bus wiring and data is read by an induction method, thus protecting any manufacturers warranty. This version of the contactless reader works on 5v and is directly compatible with the Lazer CAN bus Interface, simply (un)plugging into the interface's wiring kit.

An LED indicator light on the contactless reader confirms CAN data reception.

**Product Features**

- > Enables Can-Bus interface integration without the need for metal-to-metal connection
- > Uses induction method thereby protecting manufacturer's warranty
- > Plug & play connectivity to Lazer CAN bus interface

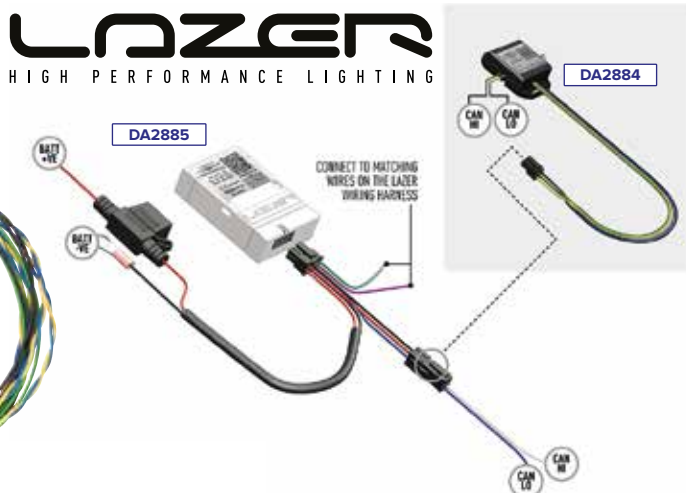



### ARB Driving Lights & Light Bars

AR21SV2



AR32SV2

#### AR32 Intensity LED Spot Light

The light features an ARB engineered heat-sink with 15 fins to help prevent heat damage to the LEDs and surrounding components. The heat-sink also ensures the LED circuits run cooler and produce optimum light output while extending the light's longevity.

Dimensions - 220.5 W x 245.5mm H

AR21SV2

#### AR21 Intensity LED Spot Light

Delivering outstanding performance in a smaller form factor, the AR21 Intensity LED spot light provides vehicle owners with a high performance lighting upgrade that is better suited to areas or bull bars with limited space.

Dimensions - 184 W x 209mm H

AR21FV2



AR32F

#### AR32 Intensity LED Flood Light

Submersible to 3m, the AR32 Intensity LED flood light is vibration tested to military specifications to ensure it can withstand extended periods of use on uneven ground and extreme conditions.

Dimensions - 220.5 W x 245.5mm H

AR21FV2

#### AR21 Intensity LED Flood Light

The AR21 Intensity LED flood light is vibration tested to military specifications and produces a wide and even beam coverage that provides the driver with confidence during night driving conditions.

Dimensions - 184 W x 209mm H



AR32EM

#### AR32EM Combination Light

Following on from the success of the innovative AR32 Intensity LED driving lights a new E-marked model is now available for legal road use in European countries. The E-Marked AR32 has all the same features as other models including upgraded mounting bracket and is designed for use with the ARB Driving Light Loom. The E-Mark symbol appears on the lower section of the lens just above the ARB logo. Submersible to 3m, the AR32EM Intensity LED combo light is vibration tested to military specifications to ensure it can withstand extended periods of use on uneven ground and extreme conditions.

Dimensions - 220.5 W x 245.5mm H

Engineered in Australia, the ARB Intensity LED light range has been specifically designed to meet the demanding requirements of 4WDers throughout the world. From producing white light that is the closest possible imitation of sunlight, to a virtually indestructible polycarbonate lens, these lights are the premium choice. Unlike high intensity discharge (HID) lights, the LED range does not require time to warm up and performs brilliantly on uneven roads by producing a broad field of light that helps diffuse vibration. Submersible to 3m, the ARB Intensity LED lights have been vibration tested to military specifications to ensure they can withstand extended periods of use on uneven ground and extreme conditions to keep the road ahead brightly lit.

Much more technical information is available for all these lights at [www.britpart.com/arb-lights](http://www.britpart.com/arb-lights)



ARM603

**ARM603** Mounting kit to suit bar tube diameter 60.3mm

**ARM761** Mounting kit to suit bar tube diameter 76.1mm

#### ARB Intensity Light Bar Mounting Kits

The ARB bull bar mounting kit provides the option to secure the Intensity LED Light Bar to bars. Available in three sizes to suit the tube diameter of vehicle's bars. Compatible with bars with a tube with a diameter of up to 76.1mm, the mounting kits provide a solid clamp between the Intensity LED Light Bar and the bar tube to minimise vibration and movement. Constructed from extruded aluminium and with fasteners manufactured from stainless steel, the bar mounting kit has been designed for toughness to handle various weather conditions.



ARMP

#### ARB Intensity Light Bar Pedestal Mounting Kit

Offering increased versatility by allowing fitment of the Intensity LED Light Bar to the pan of a bull bar or roof rack. For increased versatility, the pedestal mounting kit is an alternative to the bull bar mount by enabling fitment to the pan of a bull bar or a roof rack. All fasteners are manufactured from stainless steel, with mounting hardware manufactured from a combination of aluminium & steel.



## 4X4 ACCESSORIES

ARB products available in the UK only.



3500810



3500820

#### ARB Light Wiring Looms

More information available online **3500810 NEW**

#### ARB Light Bar Wiring Loom

Suitable for use with AR40S (Intensity light bar) & 1780500 (BASE rack roof slimline light bar). Surface mount switch with LED indicator.

**3500820 NEW**

#### ARB Light Bar Extension Loom

Suitable for use with R40S (Intensity light bar) & 1780500 (BASE rack roof slimline light bar). Extension length - 5,000mm. **3500520**

#### ARB Intensity LED Driving Light Wiring Loom

Suitable for use with AR21FV2, AR21SV2, AR32EM, AR32F & AR32SV2 (Intensity spot & flood lights). Pre-assembled plug-&-play design.



Photo by Craig Hogg



**ARB Driving Lights & Light Bars**

The ARB Intensity Solis provides a whole new level to the ARB Intensity range of driving lights and bars. Introducing digital dimming control and providing a massive 1 lux @ 1,032m for an individual spot beam via the 30 x 4W combined with 6 x 10W high output OSRAM LEDs provides a smooth driving beam.

- > Revolutionary update of the Intensity light
- > New colour design and shape
- > New interchangeable bezels
- > Superior grade LEDs and electronics
- > Digital dimming control
- > Unique ARB engineered reflectors

**Features**

- > 30 x 4W OSRAM high output LEDs
- > 6 x 10W OSRAM high output LEDs
- > Total of 36 LEDs
- > High pressure die-cast housing with improved heat-sink and UV stabilization
- > High pressure die-cast bracket with pinning holes
- > Integrated ARB thermal management
- > In-built digital dimming LED driver control
- > Unique ARB engineered spot & flood reflectors
- > 4-pin high amperage waterproof connectors
- > 50K lifespan
- > Clean and crisp light with a refined colour temperature
- > Pressure tested breather
- > Reverse polarity
- > Mil spec vibration
- > IP68
- > Over & under voltage
- > Compatible with LINX
- > Protected against RFI/EMC interference
- > RoHS, CE & ECE R10 compliant
- > Security Torx hardware included

**SJB36S**

**ARB Intensity Solis 36 LED Spot Light - Single**

Input - 10 - 30V  
Power - 165W  
Current draw - 12.4A @132V  
Output - raw - 18,178 lumens  
Output - effective - 9,546 lumens  
1 Lux reading - 1,032m  
Spread - 6 degrees  
Input cable length - 450mm  
Operating temperature - -40°C to +65°C  
Colour temperature - 5,700 Kelvin  
Weight - 3.3kg  
Connector - 4-pin AT waterproof plug  
Dimensions (W x H x D) - 225 x 220 x 120mm

**SJBLINX**

**Solis LINX Patch Cable**

Suitable for SJB36S, SJB36F & SJB21EUX2  
The ARB LINX Accessory Interface is your one-stop controller for all your off-road accessories. For software version 1.8 and up, LINX is now your optimal controller for your ARB Intensity Solis driving lights. Easily adjust light dimming, fade rate, set multiple lighting modes, and more through a simple interface. Keep your dash clear and switch-free with ARB LINX, now integrated with your ARB Intensity Solis driving lights.

- > Requires ARB LINX Accessory Interface
- > Requires ARB Intensity Solis Driving Lights
- > Enables up to 4 different preset lighting modes with ARB LINX
- > Enables LINX-controlled dimming feature for ARB Intensity Solis
- > Customize fade rate turning on/off ARB Intensity Solis lights
- > Set brightness for normal use and courtesy-light use
- > Enables ARB Intensity Solis lights as daytime running lights (in accordance with local laws)

**SJB21EUX2 NEW**

**ARB Intensity Solis 21 LED Driving Lights**

The ARB Intensity Solis™ 21 LED (7") Driving Lights are offered in dedicated combination optic tuned for on and off-road use. The lights are E-mark approved (following UNECE R149 regulation) ready for legal fitment & on road use in European countries. A single ARB Intensity Solis™ 21 provides 620m @ 1 Lux on setting #5 in off-road mode. The ARB Intensity Solis™ 21 on setting #3 provides 426m @ 1 lux with up to 40m spread from the vehicle in on-road mode. In dual combo off-road configuration, the distance down the road is a very impressive 877m @ 1 lux on setting #5 and dual combo configuration on setting #3 on-road modes it's a competitive 603m @ 1 lux. As well as distance, a warmer light colour helps to reduce eye strain over long driving periods and improves driver comfort while assisting to reduce fatigue.

**Features**

- > 21 Osram LED (15x 4W + 6x 5W)
- > 50,000+ Hour LED life span
- > Input voltage - 10-30VDC
- > Raw lumens - 9133LM
- > Colour temperature - 5700 Kelvin
- > 9° full beam width
- > Operating temperature - -40°C to +65°C
- > Weight - 2.73kg
- > Light dimensions (single) - 192 x 190 x 114mm
- > Integrated thermal management
- > Pressure equalisation breather
- > High pressure die-cast aluminium body and mount with variable positions

**High Pressure Die Cast Aluminium Bracket & Housing**

- > Scalloped back - more bar fitment possible
- > Improved heat-sink and UV stabilization
- > Adjustable bracket
- > Pressure tested breather

**Brackets**

- > Various mounting options
- > Vertical & horizontal mounting
- > Simplified fitting
- > Torx security fasteners

**Compatible With LINX**

Solis can be fully integrated into LINX. The w will need to purchase a patch lead that is simple to install + set up the new light and its features within the LINX system. Features include custom pre-sets, infinite dimming control, courtesy light feature and dedicated Solis icons and function.

**What's In The Package?**

- > Light
- > Extra (black) bezels
- > Bracket
- > User guide



See them in action at  
[www.britpart.com/solis](http://www.britpart.com/solis)

**IMPORTANT**

If you want to install Solis Lights to use with the LINX system you will need both - SJBHARN & SJBLINX, but you don't need to install the touchpad since you'll be controlling the lights through the LINX app.

**SJB36F**

**ARB Intensity Solis 36 LED Flood Light - Single**

Input - 10 - 30V  
Power - 165W  
Current draw - 12.4A @132V  
Output - raw - 18,178 lumens  
Output - effective - 8,333lumens  
1 Lux reading - 729m  
Spread - 11 degrees  
Input cable length - 450mm  
Operating temperature - -40°C to +65°C  
Colour temperature - 5,700 Kelvin  
Weight - 3.3kg  
Connector - 4-pin AT waterproof plug  
Dimensions (W x H x D) - 225 x 220 x 120mm

Much more technical information is available for all these lights at  
[www.britpart.com/arb-lights](http://www.britpart.com/arb-lights)



**SJBHARN**

**Solis Wiring Loom & Dimmer Touchpad**

**Important** - Needed to fit 2 x Solis lights

- > Silicone touch pad
- > Intuitive feel touch - no eyes off the road
- > Simple 3 button control
- > Easy fitment
- > Cable can be directed at back or out bottom
- > Percentage changes - 5%, 25%, 50%, 75%, 100%
- > Silicone sleeved for durability and protection
- > 58mm (L) x 10mm (D) x 25mm (W)
- > The touchpad is required to operate the ARB Intensity Solis™ lights if no LINX system is connected

- > Virtually unbreakable polycarbonate lens
- > UV stable moulded polycarbonate lens cover
- > Durable UV stable powder coat
- > High power Amphenol AT06 waterproof connector
- > Over voltage protection to 30VDC
- > Protected against RFI/EMC interference
- > Dust and waterproof to IP68
- > Tested to MIL810-STDG for vibration
- > RoHS compliant
- > CE compliant
- > UNECE R10 compliant
- > For Intensity Level #3 (UNECE R149 compliant)
  - Power draw 36W
  - Current draw 2.7 Amps @ 13.2V
  - Effective Lumens 2,700LM
  - Distance @ 1Lux - 426m (single light)
- > For Intensity Level #5
  - Power draw 82W
  - Current draw 6.2 Amps @ 13.2V
  - Effective Lumens 6,000LM
  - Distance @ 1Lux - 620m (single light)
- > Warranty 3 years - Global warranty

**What's In The Package?**

- > 2 x Lights & 2 x clear covers
- > 2 x Mounting bracket & mounting hardware kit
- > UV-resistant interchangeable red or black bezels to suit
- > Wiring loom with dimmer (touchpad)



**ARB INTENSITY**

**S O L I S**

**DRIVING LIGHT**



**Interchangeable bezels**





### ARB Driving Lights & Light Bars



**ARBVX17B NEW**  
ARB Intensity IQ  
Pair

#### Overview

The ARB Intensity IQ has been developed from the ground up, with performance front of mind, whilst delivering a design that complements modern vehicle styling and bar work. With a subtle introduction of ARB red within the light, the free-form clear front lens, bezel-less design and CNC machined ARB logo provide a modern, classy and premium look. Packed with unique features, the Intensity IQ sets a new level of driving light design and usability.

A unique 4-optic design (Super Spot, Spot, Flood and Midrange) is employed to provide virtually an unlimited choice of light beams to suit any road condition. The Super Spot and Spot optics, based on free-form reflector technology, produce an even spot beam for extended distance illumination. The Flood optic has a specially designed lens to maximise the light spread for excellent foreground visibility. The Midrange optics employ a conventional parabolic reflector to illuminate the midrange area. Furthermore, the beam pattern of each of the two lights can be independently adjusted so you could run, for example, one focused on spot and one focused on flood.

#### Innovative Mounting Bracket

Intelligent thermal management maximises light output in all driving conditions and provides outstanding LED life expectancy. Cooling is maximised via the die cast aluminium body which acts as a massive heat sink. An innovative, sleek new mounting bracket design not only allows adjustment of light beam angle, but also provides additional mass and surface for cooling.

#### Customisable On-board Switch

The Intensity IQ is equipped with a switch to:

- > Turn on and off the driving lights
- > Provide 8 selectable and customisable pre-set light beams
- > Disable courtesy light function (delayed light off after ignition off)
- > Turn on/off Euro mode (light beam complying UNECE R149)
- > Activate/deactivate demo mode
- > Restore factory settings



ARB products available in the UK only.



See them in action at  
[www.britpart.com/iq](http://www.britpart.com/iq)

The switch is customisable via the ARB Intensity IQ app (available via the App Store for iOS and Google Play for Android), which allows users to:

- > Turn on and off the driving lights
- > Adjust the intensity of each row of optics on each individual light (or both at once) to create your ideal beam pattern
- > Setup the fade in/out feature
- > Turn on/off courtesy feature and adjust timer
- > Activate the work light function (lights on without high beam on)
- > Select a light network to connect to (for example if you have 2 different vehicles, each with IQ lights)
- > Save or undo the change
- > Turn on and off the Euro mode
- > Set the on-board switch response time
- > Restore factory settings

#### Specification

- > LED Configuration Super Spot: 4 x Cree XP-P LEDs  
Spot: 2 x Cree XM-L3 & 3 x XP-P LEDs  
Flood: 18 x Cree XT-E LEDs  
Midrange: 4 x Cree XM-L3 LEDs
- > Input Voltage: 11-32V Power: 170W @ 13.2V  
Current: 12.9A @ 13.2V
- > Output - Raw Lumens Max Spot 7,070 Lumens  
Max Flood 14,060 Lumens
- > Output - Effective Lumens Max Flood 6,666 Lumens  
Max Combo 6,265 Lumens  
Max Spot 6,613 Lumens
- > Distance @ 1 Lux (1 Pair) Max Spot 1,350m  
Max Combo 1,105m  
Max Flood 900m
- > Operating Temp. -40°C to +80°C
- > Colour Temperature 5700 - 6200K
- > Compliance CE ECE R10, R149, UKCA, RCM, FCC, ROHS
- > Weight 3.8kg
- > Dimensions 220mm (W) x 215mm (H) x 142mm (D)
- > Warranty 3 years
- > Kit Includes 2 x Digitally controlled driving lights  
2 x Mounting brackets & mounting hardware kits  
1 x Vehicle harness  
1 x Switch with cable & connector  
1 x Control module with cable & connector  
1 x Set security bolts & tool



### LED Bumpers



These smart and functional standard fit Defender bumpers are equipped with a pair of LED lights for additional lighting in the dark or day light running for safety.



- DA8600** Front bumper with Ring LED lights
- DA8600XS** Front bumper with Ring LED lights and rubber end caps
- DA8600LED** Ring LED lights - pair  
Fitted with 5 x 1.5w ultra bright LEDs  
Dimensions - 57 H x 145 W x 55mm D / Voltage - 12 - 24V DC / Watts - 15W
- DA9500** Front bumper with LED lights
- DA9500XS** Front bumper with LED lights and rubber end caps
- DA9500LED** LED lights - pair  
Fitted with 8 x ultra bright LEDs  
Dimensions - 28 H x 140 W x 47mm D / Voltage - 10 - 30V DC / Watts - 4W



**LED Registration Plate Lights**



**XFC500040LED**  
LED Registration Plate Light  
Freelander 2/Discovery 3/Discovery 4  
Range Rover Sport - Mk1



**XFC500050LED NEW**  
LED Registration Plate Light  
Discovery 2



**XFC100540LED NEW**  
LED Registration Plate Light  
Freelander 1

**Heater Control Light Upgrade Kit**



**JFC102550B**  
Restore the Range Rover P38's heater control unit back to full brightness with this Britpart kit. Full fitting instructions are included.

**LED Interior Festoon Bulbs**



- > Premium 12V 6000K - 2 watts
- > Ideal for upgrading interior bulbs
- > LEDs produce around 200 lumens and a 6000K colour temperature
- > Lasts roughly 5 times longer than a standard bulb

**586438LED**  
Defender - 1987 onwards/Discovery 1/Discovery 2  
Freelander 1/Range Rover Classic - 1986 - 1994  
Range Rover P38  
**CZQ000010LED**  
Range Rover L322  
**RTC3633LED**  
Discovery 1/Discovery 2/Freelander 1  
Range Rover Classic - 1992 - 1994/Range Rover P38

**Smoked LED Indicator Lights**



**XGB000073LEDSM**  
Smoked LED Indicator Light - single  
Freelander 2  
Discovery 3  
Range Rover Sport - Mk1



**DA3389 NEW**  
Smoked Dynamic LED Indicators - pair  
Discovery Sport  
Range Rover Velar  
Range Rover Evoque - from EH000001 onwards  
> Plug & Play, easy install with super bright LEDs  
> CE & E-mark certificate  
> Equivalent to LR048351 & LR048352

**Clear Lights**

**XBD100760W**

Freshen up the look of your Discovery 1 with a set of these clear lens lights. Bulbs included.



**AMR6509W**



Discovery 1  
**AMR6510W** Rear bumper light assembly Right  
**AMR6509W** Rear bumper light assembly Left  
**XBD100760W** Front indicator Right  
**XBD100770W** Front indicator Left

**Spade Bulb - Ice Blue**



**DA5017 NEW**  
12V / 5W  
Ice blue spade bulb  
Equivalent to AFU4481  
Single



**DA8535 NEW**  
LED Smoked LED Indicators - pair  
Defender - Td5 onwards  
Discovery 2  
Freelander 1



Photo by Simon Ellingworth



### Individual Lights

#### Defender - 1987 - 2006 & Series 2 & 3

High quality 73mm LED lights. Supplied as singles. Unless otherwise stated Wipac branded, multi-voltage 9 - 33V, waterproof to IP67, E Marked and SAE approved, AMP type connector fitted and complete with stainless steel screws.

Fitment	Type	Clear	Amber	Red	Smoked
Front side light	LED	LR048189LED			
Front indicator	LED	LR047798LED	LR048188LED		
Side indicators - Td5 onwards - Pair	LED	DA8530*	DA8532*		DA8535*
Rear indicator	LED		LR048187LED		
Stop/tail light	LED	LR048200LEDCL		XFD100100LED	
Number plate light	LED	XFC100550LEDG			
High brake light - 2002 onwards	LED	LR044451LEDW*		LR044451LEDR*	LR044451LEDB*

These LED brake lights replace the factory fit high-level brake light. The replacement unit provides a simple plug and play fitment for quick and easy installation. These are not a replacement LED bulb. The LED brake light is supplied as a replacement moulded housing containing an E-Marked LED unit. \*Non-Wipac.



#### Defender - 2007 onwards

High quality 73mm LED lights. Supplied as singles. Unless otherwise stated Wipac branded, multi-voltage 9 - 33V, waterproof to IP67, E Marked and SAE approved, AMP type connector fitted and complete with stainless steel screws.

Type	Clear	Amber	Red	Smoked
Front side light	LED	LR048189LED		LR048189LEDSM
Front indicator	LED	LR047798LED	LR048188LED	LR048188LEDSM
Side indicators - Pair	LED	DA8530*	DA8532*	DA8535*
Rear indicator	LED	LR048187LEDCL	LR048187LED	LR048187LEDSM
Stop/tail light	LED	LR048200LEDCL		LR048200LEDSM
Fog light	LED	LR048201LEDCL		LR048201LEDSM
Reverse light	LED	LR048202LED		LR048202LEDSM
Number plate light	LED	XFC100550LEDG		
High brake light	LED	LR044451LEDW*	LR044451LEDR*	LR044451LEDB*

These LED brake lights replace the factory fit high-level brake light. The replacement unit provides a simple plug and play fitment for quick and easy installation. These are not a replacement LED bulb. The LED brake light is supplied as a replacement moulded housing containing an E-Marked LED unit. \*Non-Wipac.

LR044451LEDB



Many more images available at [www.britpart.com/lights](http://www.britpart.com/lights)

#### Defender - North American Specification (NAS) Lights

	Clear	Amber	Red	Smoked
Indicator		AMR6527*		
Stop/tail light			AMR6526*	
Reverse light	AMR6528**			
Fog light	LR048201LEDCL		LR048201***	

**Note** - \*Supplied without mounting plinth and screws. \*\*Supplied with mounting plinth but without screws. \*\*\* Supplied with mounting plinth and screws.

#### Defender - North American Specification (NAS) LED Lights

	Clear	Amber	Red	Smoked
Front side light	LED	DA1273		DA1273SM
Indicator	LED	AMR6527LEDCL	AMR6527LED	AMR6527LEDSM
Stop/tail light	LED	AMR6526LEDCL	AMR6526LED	AMR6526LEDSM
Fog light	LED	LR048201LEDCL		

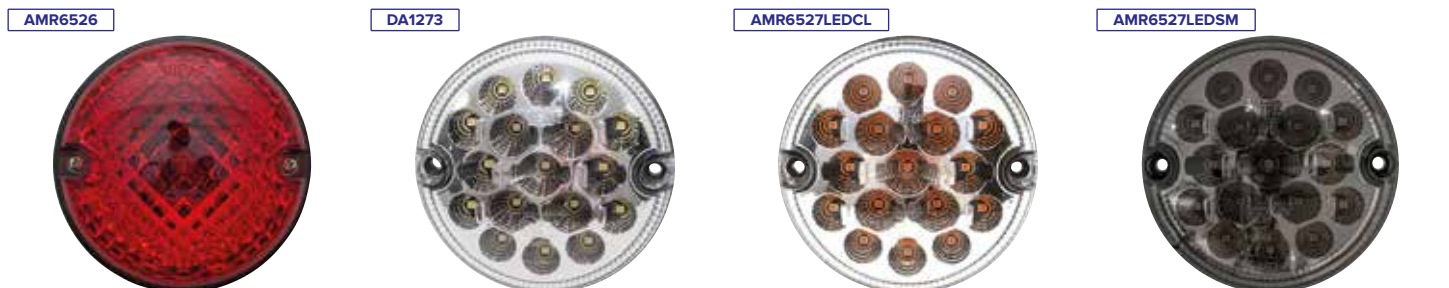

#### Sundry Items

- DA4349 ABS plastic NAS tail light guard - single
- AMR3850 Mounting plinth - single
- SE105161L Screws - pack of 10
- STC1188 Link leads - 2 wire for indicator, side, reverse and fog light
- STC4637 Link leads - 3 wire for stop and tail light
- DA114412V 12 volt smart load device kit
- DA114424V 24 volt smart load device kit

**Note** - To use the LED kit (DA1143) on a 24 volt Defender use DA114424V which replaces the 12 volt smart load device.

**PRC8876LED** 12 volt LED flasher unit  
Upgrade the standard flasher unit to the LED version. Manual adjustment to correct flasher rate. Can be used with any combination of LEDs and halogen bulbs - with or without additional loads such as trailers.





**Light Kits**



DA1077



DA1077G



DA1080G

**Defender & Series Replacement 73mm Light Kits**

- Series/Defender - up to 300Tdi
- DA1077** OEM kit
- > 2 x front side lights
  - > 4 x indicator lights
  - > 2 x stop/tail lights
- Defender - 300Tdi onwards
- Defender - Td5 - up to WA159806
- DA1080** OEM kit
- > 2 x front side lights
  - > 4 x indicator lights
  - > 2 x stop/tail lights
  - > 2 x side indicator lights



DA1291



DA1292



DA1577

**Defender & Series LED 73mm Light Kits**

- Fits all Series 3 and Defender models. It is a plug and play fitment for Defenders after 1998. Earlier vehicles require soldering or connectors fitting.
- > 2 x front LED side lights
  - > 4 x indicator LED lights
  - > 2 x stop/tail LED lights
  - > 1 x 12v LED flasher unit
- Deluxe kit also includes - reverse, fog & number plate lights.
- |                            |          |
|----------------------------|----------|
| <b>DA1192</b> Standard kit | Coloured |
| <b>DA1191</b> Standard kit | Clear    |
| <b>DA1190</b> Standard kit | Smoked   |
| <b>DA1292</b> Deluxe kit   | Coloured |
| <b>DA1291</b> Deluxe kit   | Clear    |
| <b>DA1577</b> Deluxe kit   | Smoked   |



DA1143CL



DA1143SM

Many more images available at [www.britpart.com/lights](http://www.britpart.com/lights)

**Defender North American Specification (NAS) LED Upgrade Kits**

These stylish and waterproof NAS style LED lights are a brighter alternative to the traditional halogen lighting with the added additional benefits of having a longer life (typical LED life 100,000 hours) with low energy consumption.

- > 1 x reverse LED light
  - > 1 x fog LED light
  - > 2 x indicator LED lights
  - > 2 x stop/tail LED lights
  - > 6 x plinths & screws & smart load devices
- |  |          |
|--|----------|
| <b>DA1143</b> Rear kit                         | Coloured |
| <b>DA1143CL</b> Rear kit                       | Clear    |
| <b>DA1143SM</b> Rear kit                       | Smoked   |
| <b>DA1274</b> Front kit                        | Coloured |
| <b>DA1274CL</b> Front kit                      | Clear    |
| <b>DA1274SM</b> Front kit                      | Smoked   |
| <b>DA114424V</b> 24 volt smart load device kit |          |
- Note** - To use the LED kit (DA1143) on a 24 volt Defender use DA114424V which replaces the 12 volt smart load device.

**LED Headlights - Britpart Lynx Eye**



Defender, Series & Range Rover Classic  
Durable polycarbonate lens & die-cast aluminium housing provide maximum protection

Right hand drive	<b>DA6282</b>	Pair	<b>DA6282K NEW</b>	Single
Left hand drive	<b>DA6283</b>	Pair	<b>DA6283K NEW</b>	Single

- Features & Benefits**
- > Standard 7" fitment
  - > Light source - 8pcs CREE(XML-10W) LED
  - > Certification - DOT & E-mark
  - > 2800LM@30W on low beam
  - > 4450LM@48W on high beam
  - > Durable polycarbonate lens stands up to harsh environmental conditions
  - > Rugged solid LED means never having to replace another bulb again
  - > Die-cast aluminium housing provides maximum protection



**Note** - Some EU countries may require fitment of headlight washers.

- General Specifications**
- > Lens material: Polycarbonate
  - > Housing material: Die-cast aluminium
  - > Mounting: Replaces PAR56 headlights
  - > Mounting connector: H4 and H4 to H13 converter
  - > Colour temperature: 6000-6500k

- Technical Specifications**
- > Low beam: 2.5 amps @ 12V DC
  - > High beam: 2.00 amps @ 24V DC
  - > Low beam: 1.25 amps @ 24V DC
  - > Row lumen output: 5600LM
  - > Effective lumen output: 3640LM



### Lynx Halo



Daylight Running Lights



Side Lights



Dipped Lights



Main Beam Lights



- > High beam
- > Low beam
- > Daylight running lights
- > Side lights
- > Safe beam - no glare to oncoming traffic
- > Plug & play
- > ECE - R10, R148 & R149
- > EMC - CISPR 25 Class 4
- > DOT

# LYNX HALO

- > Plug & play
- > High brightness
- > IP67 passed
- > Never replace a bulb
- > 'Error-canceller' build-in
- > UV-resistant & hard-coated polycarbonate lens
- > Universal under DC9V - DC32V
- > Best cut-off-line with broad light-spread
- > Excellent pure white light output
- > Long life-span up to 30,000 hours
- > High reliability
- > Multi-functional combination

## LED Sealed Beam Headlights

<b>DA3462 NEW</b>	Right hand drive	Pair
<b>DA3462K NEW</b>	Right hand drive	Single
<b>DA3463 NEW</b>	Left hand drive	Pair
<b>DA3463K NEW</b>	Left hand drive	Single



Photo by Car Throttle

## Britpart x Car Throttle

We are delighted to share with you two special Car Throttle episodes! This exciting project filmed at Britpart HQ, puts a Discovery 2 & Discovery 3 to the test. In Episode 1 the Car Throttle presenters, Alex, Jack & Ethan, prepare the vehicles with the help of the Britpart team and our friends from TerraFirma. Episode 2 follows as the team as the embark on a camping adventure and put the vehicles to the test in the off-road arena!

Watch episode one here - [www.britpart.com/throttle1](http://www.britpart.com/throttle1)

Watch episode two here - [www.britpart.com/throttle2](http://www.britpart.com/throttle2)



**Replacement Headlights**

Replacement headlights for Series, Defender & Range Rover Classic  
 > Clear lenses and profiled back reflector offer brilliant lighting  
 > Fully E-marked

**Crystal Halogen - No bulb**

<b>RTC4615C</b>	Right hand drive - Britpart	Pair
<b>RTC4615CW</b>	Right hand drive - Wipac	Pair
<b>PRC7994C</b>	Left hand drive - Britpart	Pair

**Note** - Bulbs for the above are not included

<b>589783</b>	Bulb - 60/55W H4	Single
---------------	------------------	--------

**Sealed Beam to Halogen - With Bulbs**

<b>RTC4615K</b>	Right hand drive - Britpart	Pair
<b>RTC4615KW</b>	Right hand drive - Wipac	Pair
<b>PRC7994KW</b>	Left hand drive - Wipac	Pair

**Seal Beam to Halogen - No Bulb**

<b>RTC4615</b>	Right hand drive - no bulb - Britpart	Single
<b>RTC4615W</b>	Right hand drive - no bulb - Wipac	Single
<b>PRC7994W</b>	Left hand drive - no bulb - Wipac	Single
<b>589783</b>	Bulb - 60/55W H4	Single

**Halogen Headlight Unit Assembly**

<b>BAU2144</b>	Right hand drive	Single
<b>AEU1742</b>	Left hand drive	Single

**Note** - When replacing sealed beam to these halogen units both headlights have to be replaced.



**LED Headlights - ECE**



Series		
Defender		
Range Rover Classic		
<b>DA6280K</b>	Right hand drive	Pair
<b>DA6281K</b>	Left hand drive	Pair

**Technical Specifications**

- > Hard-coated polycarbonate lens
- > eCoat aluminium housing and internal structures
- > Metallized reflector
- > 1.3mm CSA / 16 gauge wire
- > Light source - 2 LED arrays
- > Multi-volt (9V-33V) design works with both 12V and 24V systems
- > More technical information available online

**Note** - Some EU countries may require fitment of headlight washers.

**Features & Benefits**

- > ECE & ROHS compliant
- > LED sealed beam technology with polycarbonate lens and sealed electronics
- > Up to 50 x longer life than halogen headlights, lowering life-cycle costs
- > Produces pure white light, nearly identical to daylight that is easy on the eye, unlike harsh blue HID systems
- > Includes built-in position light with optional wiring
- > Offers great forward vision, improved roadside coverage and highly controlled beam patterns, offering glare protection to oncoming traffic
- > Dipped/passing beam and main/driving beam functionality
- > Ultra-bright output for maximum night visibility
- > H4, 3-Blade connector system (main & dipped beam only)

**Xenon Ultima Headlight Upgrade**



**DA5014**

Right hand drive  
 Pair  
 Xenon 7" universal fit headlight upgrade kit includes Xenon Ultima bulbs.  
 Suitable for Defenders, Series and Range Rover Classic. Xenon Ultima is the first auto bulb to put 120% more light on the road. The lights have a complex surface to give a superior light distribution. They are E-approved, fully road legal and the kit includes headlight units and xenon bulbs. 3 year warranty.

**Lucas Headlight Bowl Kit**



**DA3208LUCAS**

Headlight bowl kit  
 Steel - pair  
 Series 1, 2 & 3  
 Defender  
 Range Rover  
 Classic



Photo by Ryan Ramsamoj

**Light Mounting Kits**



Replacement plastic bowls for standard 7" headlight mountings on Defenders & Series.

<b>DA3010</b>	7" Headlight		<b>DA3010B</b>	7" Headlight		<b>DA1158</b>	7" Headlight fixing kit - Less bowl	<b>STC3018SS</b>	7" Headlight mounting bezel
Chrome bezel	Single		Black bezel	Single		Black bezel	Single	Stainless steel	Single



### Range Rover Classic Lucas Classic 4x4 Replacement Lens Covers



Front indicator lens  
Range Rover Classic  
**AEU1610LUCAS** Right hand side  
**AEU1609LUCAS** Left hand side



Rear light lens assembly with black border  
Range Rover Classic  
**RTC4590LUCAS** Right hand side  
**RTC4591LUCAS** Left hand side



Rear light lens side with black border  
Range Rover Classic  
**RTC4588LUCAS** Right hand side  
**RTC4589LUCAS** Left hand side



Rear light lens assembly  
Range Rover Classic  
**RTC5989LUCAS** Right hand side  
**RTC5990LUCAS** Left hand side



Rear light lens side  
Range Rover Classic  
**RTC5294LUCAS** Right hand side  
**RTC5295LUCAS** Left hand side



Refresh the look of your Range Rover Classic

### Osram Xenarc Night Breaker Laser D3S

**DA5201**

**Osram Xenarc Night Breaker Laser D3S**

**Up to 200% more brightness** - To see further and therefore react sooner compared to the minimum legal standard

**Up to 250m long beam** - For better visibility

**Up to 20% whiter light** - Compared to the minimum legal standard (close to laser look)

The most powerful xenon light from Osram Xenarc Night Breaker Laser is the brightest Osram xenon light. This powerful light with efficient xenon technology ensures a better visibility on the road: up to 200% more brightness compared to the minimum legal standard.

More light allows to see further and therefore react sooner. Added to this is the up to 250 meter long beam and up to 20% whiter light, close to laser look (compared to the minimum legal standard).

**Note** - XENARC light change is recommended to be carried out by a professional and in pairs.

Power input - 35W  
Nominal voltage - 42.0V  
Nominal wattage - 35.00W  
Test voltage - 13.5V  
Power input tolerance - ±3%  
Luminous flux - 3200lm  
Luminous flux tolerance - ±15%

Colour temperature - 4400K  
Diameter - 9mm  
Product weight - 63.00g  
Length - 80.0mm  
Lifespan B3 - 2000h  
Lifespan Tc - 3000h



### Osram Xenarc Cool Blue Intense Extra White Light

**DA5094-150 NEW**

**Osram Xenarc Cool Blue Intense Extra White Light**  
*Extra white light for stylish LED look*

Extra white light due to a special filling system used instead of conventional coating

**Up to 6,200 Kelvin**

High contrast and brilliantly white light for most stylish and modern look on the road

**Up to 150% more brightness**

More light allows to see farther and therefore react sooner

Xenarc Cool Blue Intense - discover that modern look at high power! With its extra white light for LED look,

high contrast xenon light, this automotive lamp appeals especially to drivers who like the perfect combination

of stylish and individual design with exceptional road illumination. The high-tech xenon light with colour

temperatures of up to 6,200 Kelvin comes up with a highly efficient technology, brilliant effect and no-compromise

design. Thanks to a special filling system which is used instead of conventional coating the lamp emits its extra white light. This stylish light creates a high attention effect that helps you to be better seen by other motorists. Discover the exceptionally bright, high-contrast and brilliantly white light with up to 6,200 Kelvin and 150% more brightness! With Xenarc Cool Blue Intense, the night turns into day. Please note: XENARC lamp change is recommended to be carried out by a professional. More technical details available online.



### Xenon Performance Headlight Bulbs

**DA5052**



**DA5052** Ultima H1 fitment Pair

**DA5053-130**



**DA5016-130** Xenon 130 H4 fitment Pair  
**DA5053-130** Xenon 130 H11 fitment Pair



**DA5016-150** Xenon 150 H4 fitment Pair  
**DA5024-150** Xenon 150 H7 fitment Pair  
**DA5053-150 NEW** Xenon 150 H11 fitment Pair

**DA5024-150**

**DA5094**



**DA5094** Ring Xenon HID5500 performance upgrade bulb

- > Ultima - up to 120% more light on the road
- > Xenon 130 - up to 130% more light on the road
- > Xenon 150 - up to 150% more light on the road
- > 100% Xenon gas and advanced filament technology produce exceptional night driving performance
- > A longer beam pattern enables other road users to be seen more clearly and allows more time to react to potential hazards
- > Better reflections from road markings and signs make for more comfortable and safer night driving
- > Street legal and a simple upgrade from standard bulbs, requiring no changes to vehicle wiring

- > D1S 85V 35W
- > 20% more light than a standard HID bulb
- > 5500K colour temperature for a whiter light
- > Direct OE replacement for existing discharge bulb
- > Typical life 3000 hours

### Spare Light Bulb Kits

**DA5018** H1 kit  
**DA5019** H4 kit  
**DA5020** H7 kit

Compact kits for easy storage in glove compartment. Contains major bulbs for exterior lighting and fuses. Kit includes:

- > Relevant headlight bulb
- > R380 stop/tail bulb
- > R382 stop/indicator bulb
- > R581 amber indicator bulb
- > R501 capless side and tail bulb
- > R207S side and tail bulb
- > 10A mini blade fuse
- > 10A standard blade fuse

**DA5019**



**DA5021** H7/H11 kit  
Kit includes:

- > 1 x H7
- > 1 x H11
- > 2 x R380 - clear
- > 2 x R382 - clear
- > 1 x R581 - amber
- > 2 x R501 - clear
- > 1 x R501 - amber
- > 1 x R239 - clear
- 1 x 10A mini blade fuse
- > 1 x 10A blade fuse



**Britpart**



**Exterior Lights**



**DA1146**  
**LED Exterior Work Light**  
 3 watt with smart matt black aluminium housing. Input voltage 10-30 volts. Waterproof to IP67 standards. 85mm diameter with mounting bracket. Incredibly bright and in most cases will not require a relay due to the 3 watt load.

**Verdict**  
*"Robust and gives a useful spread of light."*  
 Neil Watterson, LRO Deputy Editor



**DA4120**  
**Hella Torero 5760 Work Light**  
 Long-range illumination H3 work light with handle. Includes universal mount (swivel) with M10 mounting screw for upright or pendant mounting. Prism optics for long-range illumination. The housing is made of black plastic, with a prominent edge to protect the lens. The reflector of steel sheet is bonded to the glass lens. With switch, vibration damper and guard.

- > Rated voltage: 12/24 volts
  - > Recommended inclination angle: 15° - 20°
  - > Range: 40m
  - > Light exit diameter: 120mm
  - > Diameter: 152mm
  - > Overall height: 239mm
  - > Protection: IP5K4K
- Suitable bulb: H3 (Halogen) not included  
 Part no. 12v - 606178



**DA5073**  
**Dual Voltage Round Switched Work Light**

- > Dual voltage
- > H3 bulb fitment
- > Bulb not included - DA5075
- > Wide flood light output
- > Heavy duty zinc plated bracket
- > Clear polycarbonate lens
- > Impact and heat resistant polypropylene housing
- > Protected switch
- > 253 H x 168 W x 119mm D
- > Voltage - 12/24V DC
- > Watts - 55/70W
- > Cap type - PK22s

**DA5075**  
 12V, 55W  
 H3 Halogen bulb



**DA5090A**  
**LED Work Light**

- > Power - 16 x 1W Osram LED
- > Lumens - 1,200LM
- > Voltage - 9 - 32V
- > Waterproof & Dustproof - IP68
- > E-Mark Approved
- > Maximum wattage - 13.298W
- > Maximum current draw - 0.4836A
- > Housing - Die-cast aluminium
- > Lens - Durable polycarbonate
- > Size - 90 x 88 x 29.8mm
- > Cable length - 250mm



**DA5090**

**DA5090**  
**Ring LED Switched 15W Work Light**

- > Rear power switch
- > Operating voltage: 10-30V
- > Maximum wattage: 15W
- > Maximum current draw: 1.3A @ 12V
- > Waterproof: IP67
- > Housing & lens: Diecast aluminium/ Polycarbonate
- > Cable length: 300mm
- > 125 H x 110 W x 40mm D

Add some light to your working environment.



For work lights see Tools section



Photo by Louise Thompson



### LED Strip Lights

#### Astro 12V LED Strip Lights

- > Long life, high intensity LEDs
- > Wide spread of light
- > Angled light source
- > Quick to install
- > Compact design
- > Waterproof to IP66
- > E-type approved

The Astro gives a wide spread of light; perfectly angled for awning and area lighting. The lights incorporate the Orion LED strip light which uses the latest in LED technology, offering optimum performance and extended life. The properties of these LEDs give greater luminosity, allowing for a brighter unit whilst using fewer LEDs to maintain the low power draw. The Astro is approximately twice as long as a standard awning light, thereby increasing the spread of light along the side of a vehicle offering greater external illumination. The angled wash of light to the floor also makes it a perfect light source to illuminate work areas, shelving, lockers and much more. The LED strip sits within a slim aluminium housing which conceals the fixings; and with ABS snap-on end caps, this compact light unit is quick and easy to install. The PCB driver, components and LEDs are completely encased within a polycarbonate extrusion, which protects against moisture ingress.

Perfect light source to illuminate work areas

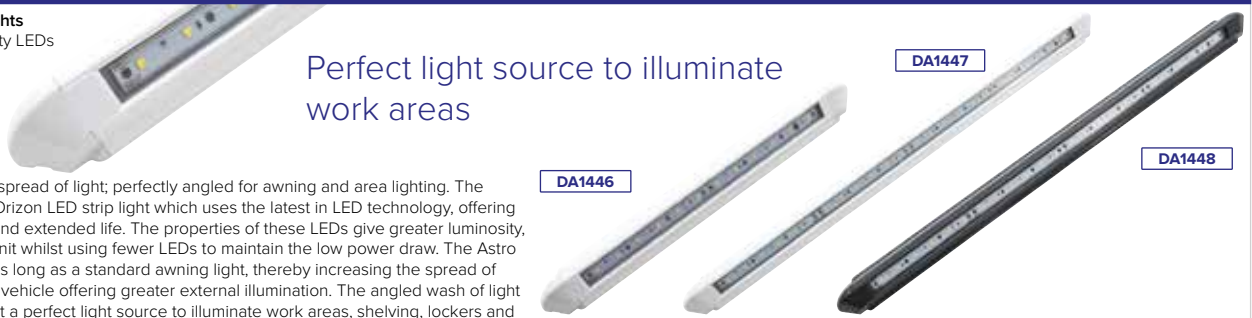

DA1446

DA1447

DA1448

#### Astro Lights

Voltage range (VDC)  
Average current (A)  
Light output (lm)  
Watts (W)  
Size (L x W x H mm)  
Temp. range (°C)  
IP rating (IP)

#### DA1446

**250mm White**  
10 - 14  
0.24  
320  
3  
343 x 43 x 31  
-30 to +40  
IP66

#### DA1447

**500mm White**  
10 - 14  
0.44  
640  
6  
593 x 43 x 31  
-30 to +40  
IP66

#### DA1448

**500mm Grey**  
10 - 14  
0.44  
640  
6  
593 x 43 x 31  
-30 to +40  
IP66

### Optimum performance & extended life

#### Nebula 12V LED Strip Lights

- > Long life, high intensity LEDs
- > Quick to install
- > Compact design
- > Robust construction
- > Unique impact deflection design
- > E-type approved

The Nebula incorporates the Orion LED strip light, which uses the latest in LED technology, offering optimum performance and extended life. The properties of these LEDs give greater luminosity, allowing for a brighter unit whilst using fewer LEDs to maintain the low power draw. Set in a low profile, tough aluminium housing, the Nebula is quick and easy to install, making it suitable for both new vehicle specifications and retrofitting into existing vehicles.



DA1450

DA1452



#### Nebula Lights

Voltage range (VDC)  
Average current (A)  
Light output (lm)  
Watts (W)  
Size (L x W x H mm)  
Temperature range (°C)  
IP rating (IP)

#### DA1450

**250mm with switch**  
10 - 14  
0.24  
320  
3  
376 x 44 x 14  
-30 to +40  
IP60

#### DA1452

**500mm with switch**  
10 - 14  
0.44  
640  
6  
624 x 44 x 14  
-30 to +40  
IP60



### LED Map Light



#### DA1459

- > Dual colour
- > Very low power - only 0.07A
- > Durable adjustable arm
- > Slimline design
- > Integrated switch

Voltage range (VDC)  
Average current (A)  
Light output (lm)  
Watts (W)  
Size (L x W x H mm)  
Temperature range (°C)

10 - 14  
0.07  
72  
0.85  
460 x 35 x 18  
-30 to +40



Photo by Richard Jones

### LED Interior Festoon Bulbs



- > Premium 12V 6000K - 2 watts
- > Ideal for upgrading interior bulbs
- > LEDs produce around 200 lumens and a 6000K colour temperature
- > Lasts roughly 5 times longer than a standard bulb

#### 586438LED

Defender - 1987 onwards/Discovery 1/Discovery 2  
Freelander 1/Range Rover Classic - 1986 - 1994  
Range Rover P38

#### CZQ00010LED

Range Rover L322

#### RTC3633LED

Discovery 1/Discovery 2/Freelander 1  
Range Rover Classic - 1992 - 1994/Range Rover P38



# TOWING

Get Hitched Up With  
Towing Parts For All  
Land Rover Models



# TOWING

All Models

## Towing Hitches

			
<b>201691</b>	<b>DA2123</b>	<b>DA5100</b>	<b>KNB100640G</b>
Ball, jaw & pin Heavy-duty 4 bolt mounted (ball 3½ ton/jaw 5 ton)			
<b>DA2123</b>	<b>NRC2051</b>	<b>RTC8891AA</b>	<b>RTC8891AAB</b>
Ball, jaw & pin (RTC8159/LR008244)		Silver	Black
<b>DA5100</b>		50mm tow ball	
Tow hitch (3½ ton)		3.5 ton EU approved. 90mm fixing centres	
<b>KNB100640G</b>		2 x M16 mounting bolt fixing holes	
Towing jaw (3½ ton)		Approved to Reg 55 Will fit any flange type tow bar	
<b>KNB100640</b>			
Towing jaw (3½ ton)			
<b>NRC2051</b>			
NATO Tow hitch			

## Ancillary Parts

				
<b>67187</b>	<b>DA2194</b>	<b>DA2196</b>	<b>DA2197</b>	<b>DA2123A</b>
Pin universal coupling - heavy-duty (201691)	Replacement pin for DA2123	Replacement slider pin	Replacement slider pin 'R Clip'	Replacement chain, tag & clip
				
<b>DA1881</b>	<b>DA1661</b>	<b>DA1342</b>	<b>ANR3635</b>	<b>DA2129</b>
Ring black coated steel mounting plate. Suitable for most tow balls and 7-pin & 13-pin sockets. Designed for two bolt style towball connections and is corrosion resistant and durable. Single.	Replacement towing electrics mounting plate	1.5" tow ball spacer block kit	50mm tow ball cover	Adjustable tow hitch kit
				
<b>DA1831</b>	<b>DA2195</b>	<b>DA2118</b>	<b>RTC8831</b>	<b>579408</b>
Replacement slider bracket - 2-pin - fits DA2129 (PCT kit)	Replacement slider bracket - 1-pin	Replacement slider bracket - 2-pin	Saddle slider	7-pin trailer plug
				
<b>DA5023</b>	<b>DA1825</b>	<b>DA3409</b>	<b>DA5025</b>	<b>DA1126</b>
7-pin to 13-pin adaptor - to use on vehicles with 7-pin towing electric sockets	Mini short adapter from 13-pin socket to 7-pin plug. With coated contact for safe and reliable connections.	N-Type flexible socket seal	13-pin to 2 x 7-pin adaptor - 12N/12S Ideal for when vehicles with a 13-pin socket are required to tow caravan/trailer with twin 7-pin plugs.	Universal towing electrics - 12N Rear audible relay kit with pre-wired 2m cable
				
<b>DA3432</b>	<b>DA3432</b>	<b>DA3432</b>	<b>DA3432</b>	
Pre-wired 13-pin socket with 2m of 12 core sheathed cable and flexible gasket				





**Towing Hitches**



<b>DA2121</b>	Defender 90/110 - up to WA	Adjustable kit (RTC8828AA)
<b>DA2136</b>	Defender 90 - XA onwards	Towbar assembly (VUB105460) No electrics
<b>DA2137</b>	Defender 110 - XA onwards	Towbar assembly (VUB105470) No electrics
<b>LR007221</b>	Defender 90 - Td5 & 2007 onwards	Adjustable tow kit - less tow ball
<b>LR007222</b>	Defender 110 - Td5 & 2007 onwards	Adjustable tow kit - less tow ball
<b>LR007223</b>	Defender 110/130 - Hi-Cap pickup - 1998 onwards	Adjustable tow kit (STC50257AB)
<b>STC50269AA</b>	Defender 90 - XA onwards	Rear step
<b>STC50269AAB</b>	Replacement bung for STC50269AA	
<b>STC50301</b>	Defender 110 - XA onwards	Rear step
<b>VPLDT0086LR</b>	Defender 110 - High-Cap pickup - 2007 onwards Defender 130 - Crew cab - 2007 onwards	
<b>242139</b>	Defender - all models	Multi-height tow bar with tow ball
<b>DA2903</b>	Defender 2020	Front towing eye Recovery eye - single



**Ancillary Parts**



<b>LR005919</b>	Defender - 2007 onwards - all models	13-pin socket electrics kit
<b>LR005920</b>	Defender - 2007 onwards - all models	'N' Type electrics kit
<b>LR005921</b>	Defender - 2007 onwards - all models	'S' Type electrics kit - front
<b>STC4286</b>	Defender - all models	12N 7-pin socket
<b>YWJ101500</b>	Defender - Td5	'N' Type electrics plug
<b>DA2948</b>	Defender 2020 - 90 & 110	7-Pin wiring harness
<b>DA2949</b>	Defender 2020 - 90 & 110	13-Pin wiring harness

Britpart have all the equipment to get you **hitched up and towing**



### Towing Hitches



<b>DA2134</b>	Discovery 1 - up to 1994 Includes electrics (not plug-in) (STC8816)	Tow kit
<b>DA2125</b>	Discovery 1	Adjustable tow hitch kit
<b>DA2138</b>	Discovery 2 Includes electrics (not plug-in), excludes tow ball	Towing kit
<b>STC50289AB</b>	Discovery 2 No electrics	Tow kit - air suspension
<b>STC50319</b>	Discovery 2 None sliding adjuster - no electrics	Multi-height tow kit
<b>LR071295</b>	Discovery 3/Discovery 4 Quick disconnect without height adjustment	Towing hook assembly Less Canada, Mexico & USA Replacement lock
<b>KNW500020</b>	Discovery 3/Discovery 4 For KNB500070 & LR071295	
<b>LR070497</b>	Discovery 4 Drop plate, quick disconnect	Adjustable tow hook kit Less Canada, USA & Australia
<b>LR070497G</b>	Discovery 4	Adjustable tow hook kit Less Canada, Mexico & USA
<b>VPLRT0171G NEW</b>	Discovery 5	Detachable tow bracket
<b>VPLRT0175G NEW</b>	Discovery 5	Multi-height tow bracket
<b>VPLRT0171LR</b>	Discovery 5	Detachable tow bracket
<b>VPLRT0175LR</b>	Discovery 5	Multi-height tow bracket
<b>VPLCT0140LR</b>	Discovery Sport 5-seat/7-seat (without spare wheel)	Kit tow bar - flange ball
<b>VPLCT0147</b>	Discovery Sport 5-seat/7-seat (without spare wheel)	Kit tow bar - quick release
<b>VPLCT0148LR</b>	Discovery Sport 7-seat (with spare wheel)	Kit tow bar - quick release
<b>VPLCT0148</b>	Discovery Sport 7-seat (with spare wheel)	Kit tow bar - quick release
<b>LR061295LR</b>	Discovery Sport	Bumper cover



Photo by Craig Hogg



**Ancillary Parts**



<b>ANR3896</b> <b>NEW</b>	Discovery 1 - from MA118310	Tow Bar Electrics - Plug-in Type	<b>YWJ500201</b>	Discovery 3	Tow bar electrics kit 'N' & 'S' type - Great Britain & Ireland
<b>STC4286</b>	Discovery 1	12N 7-pin socket	<b>VPLAT0011</b>	Discovery 4 - up to DA999999	12N/12S 7-pin electric socket
<b>YWT10002L</b>	Discovery 1	Electronic flasher unit for towing	<b>VPLCT0244</b>	Discovery Sport	Tow bar electrics - 13-pin
<b>STC50081</b>	Discovery 2	'N' Type electrics socket	<b>VPLCT0182</b>	Discovery Sport	Tow bar electrics - 13-pin
<b>STC50181LR</b>	Discovery 2	'N' Type electrics socket - less front fog lights	<b>DA1326</b>	Discovery Sport	Tow bar electrics - 13-pin
<b>STC50389</b>	Discovery 2	Socket - split charge 'S' type post 1999 caravan			
<b>DA2602</b>	Discovery 3	Tow bar electrics kit - 13-pin (YWJ500160) - plug in electrics			



Photo by Simon Sanchez



# TOWING

## Freelander

### Towing Hitches

KNK500060



KNK500070



VPLFT0120



VPLFT0118



VPLFT0119



**KNK500060** Freelander 1  
Tow bracket kit  
European style fixed swan neck

**KNK500070** Freelander 1  
Tow bracket kit

**VPLFT0120** Freelander 2  
- DH000001 onwards  
Tow bracket kit - swan neck

**VPLFT0118** Freelander 2  
Tow bracket kit

**VPLFT0119** Freelander 2  
Tow bracket kit - detachable ball tow bar  
Excluding body styling kit



Photo by Pete Bell

### Ancillary Parts

STC50459



YMZ101030



YWT10002L



VPLFT0001



VPLFT0105



VPLFT0077



VPLFT0106



<b>STC50459</b>	Freelander 1	Electrical assembly kit	12S pre-1999 caravan auxiliary electrics
<b>YMZ101030</b>	Freelander 1	Electrical assembly kit	7-pin 12N lighting
<b>YWT10002L</b>	Freelander 1	Electronic flasher unit for towing	
<b>VPLFT0001</b>	Freelander 2 - up to DH	Electrical assembly kit	12N/12S 7-pin socket (LR003106)
<b>VPLFT0105</b>	Freelander 2 - DH onwards	Electrical assembly kit	12N/12S 7-pin socket
<b>VPLFT0077</b>	Freelander 2 - CH000001 - CH999999	Electrical assembly kit	13-pin socket
<b>VPLFT0106</b>	Freelander 2 - DH onwards	Electrical assembly kit	13-pin socket



### Series



**242139**  
Series - all models  
Front towing eye



**DA2012**  
Series - SWB  
Drop plate - standard



**DA2133**  
Series - all models  
Drop plate - extended



Photo by Mark Strangways



**Towing Hitches**



<b>DA2134</b>	Range Rover Classic Tow kit (STC8816) up to 1994 - Includes electrics but not plug-in electrics
<b>DA2125</b>	Range Rover Classic - 1992 - 1994 Adjustable tow hitch kit
<b>DA4030</b>	Range Rover P38 Tow kit <b>Note</b> - No tow ball included. It is not a Swan neck type, a standard 50mm tow ball is required (RTC8891AA). Electrics are included but not plug-in.
<b>LR071295</b>	Range Rover Sport - 2005 - 2013 - Less Canada, Mexico, USA & Australia Towing hook assembly. Quick disconnect without height adjustment
<b>KNW500020</b>	Range Rover Sport - 2005 - 2013 Replacement lock for KNB500070 & LR071295
<b>LR070497</b>	Range Rover Sport - 2010 - 2013 - Less Canada, USA & Australia Adjustable tow hook kit. Drop Plate, Quick Disconnect
<b>LR070497G</b>	Range Rover Sport - 2010 - 2013 - Less Canada, Mexico & USA Adjustable tow hook kit
<b>VPLWT0159</b>	Range Rover Sport - 2014 onwards Fixed multi-height tow bracket kit
<b>DA5030</b>	Range Rover L322 Towbar/flange towball - equivalent to VUB000740 & VUB000720
<b>VUB000720</b>	Range Rover L322 - inc. 2010 onwards - Less Canada, Mexico & USA Multi-height tow bar includes carry bag
<b>VUB000730</b>	Range Rover L322 - inc. 2010 onwards - Less Canada, Mexico & USA Quick release tow bar
<b>VUB503960</b>	Range Rover L322 - inc. 2010 onwards Tow bar armature. Towing subframe - 6A000001 onwards
<b>VPLGT0082</b>	Range Rover L405 Tow kit bracket - swan neck fixed
<b>VPLVT0065</b>	Range Rover Evoque Tow kit bracket - swan neck fixed
<b>VPLVT0069</b>	Range Rover Evoque - up to DH715459 Tow kit bracket - quick release tow bar
<b>VPLVT0078</b>	Range Rover Evoque - up to DH715459 Tow kit bracket - flange ball



Photo by Shane McEwan



# TOWING

## Range Rover

### Ancillary Parts

**YWT10002L**



**DA2602**



**YWJ500150**



**VPLST0014**



**VPLWT0114**



**VUH000020**



**YWC000840**



**YWJ500450**



**VPLMT0006**



**YWJ500460**



**VPLGT0073**



**VPLVT0245G**



<b>YWT10002L</b>	Range Rover Classic - 1992 - 1994 Electronic flasher unit for towing
<b>DA2602</b>	Range Rover Sport - 2005 - 2009 Tow bar electrics kit 13-pin (YWJ500160) Plug in electrics
<b>YWJ500150</b>	Range Rover Sport - 2005 - 2009 - Less Canada, Mexico, USA Tow bar electrics kit - 12'N' & 12'S' type - 7-pin
<b>VPLST0014</b>	Range Rover Sport - 2010 - 2013 Less Canada, Mexico, USA Capped at BA999999 Tow bar electrics kit - 12'N' & 12'S' type - 7-pin
<b>VPLWT0114</b>	Range Rover Sport - 2014 onwards Tow bar electrics kit - 13-pin
<b>VUH000020</b>	Range Rover L322 - up to 2006 Towing electrics with 13-pin socket, harness & control unit module (YWC000840)
<b>YWC000840</b>	Range Rover L322 Towing electrics control unit module

<b>YWJ500450</b>	Range Rover L322 - 2002 - 2009 - Less Canada, Mexico & USA Tow bar electrics kit - 12'N' & 12'S' type - 7-pin
<b>VPLMT0006</b>	Range Rover L322 - 2010 - 2012 - Less Canada, Mexico & USA Tow bar electrics kit - 12'N' & 12'S' type - 7-pin
<b>YWJ500460</b>	Range Rover L322 - 6A000001 - up to 2009 Less Canada, Mexico & USA Tow bar electric 13-pin socket & harness
<b>VPLGT0073</b>	Range Rover L405 - Less Canada, Mexico, USA & Australia Tow bar electrics - 13-pin socket & harness
<b>VPLVT0245G</b>	Range Rover Evoque - Less Canada, Mexico, USA & Australia Tow bar electrics - 13-pin





Protection For Those  
Muddy Occasions



# INTERIOR PROTECTION



# INTERIOR PROTECTION

## Dog Guards

<b>DA4027</b>	Defender 90/110 - 1987 - 2006 & 2007 onwards - hardtop with bulkhead Series - hardtop with bulkhead	Half height	Mesh type	Grey
<b>DA4027KIT</b>	Replacement fitting kit for dog guard DA4027 <b>NEW</b>			
<b>STC7555</b>	Defender 110 - County Station Wagon - 1987 - 2006 Defender 90/110 - Commercial with bulkhead removal bar fitted - 1987 - 2006	Full height - 1 piece	Mesh type	Grey
<b>STC50479</b>	Defender 90 - less bulkhead	Full height - 2 piece	Mesh type	Black
<b>DA5539</b>	Defender 110 - County Station Wagon & Utility - 2007 onwards without bulkhead	Full height	Mesh type	Black
<b>STC8414</b>	Discovery 1	Half height	Mesh type	Grey
<b>STC50323</b>	Discovery 2	Half height	Mesh type	Grey
<b>DA5511A</b>	Discovery 3/Discovery 4	Half height	Mesh type	Black
<b>VUB501170LR</b>	Discovery 3/Discovery 4	Full height	Mesh type	Black
<b>VPLCS0300</b>	Discovery Sport	Half height - loadspace compartment partition	Mesh type	Black
<b>DA5812</b>	Discovery Sport	Half height	Mesh type	Black
<b>STC7939AB</b>	Freelander 1	Full height	Bar & mesh type	Grey
<b>DA5801A</b>	Freelander 2	Half height	Bar type	Grey
<b>LR002521LR</b>	Freelander 2	Full height/full width	Mesh type	Black

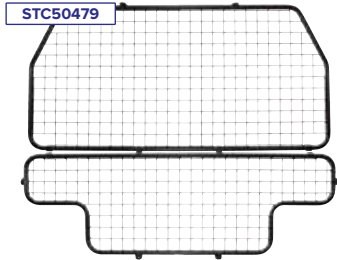
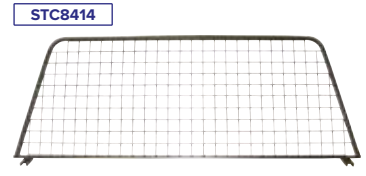
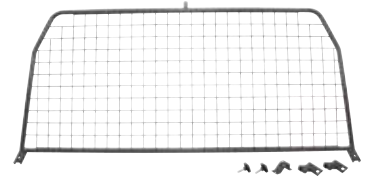

Keep Rover **firmly** in his place!

For more images [www.britpart.com/dog](http://www.britpart.com/dog)

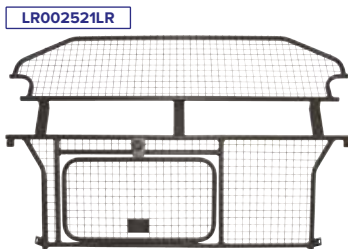
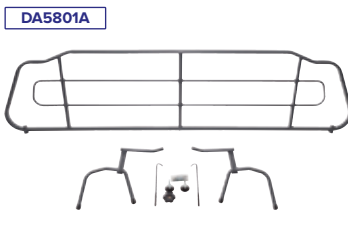
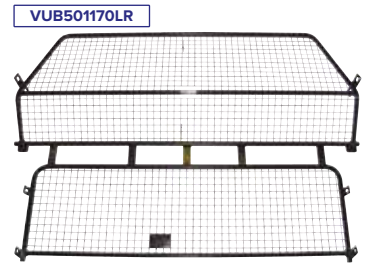
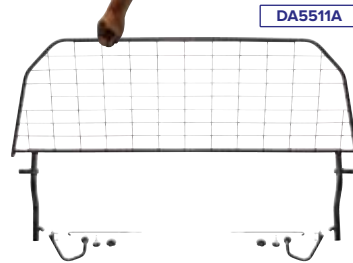
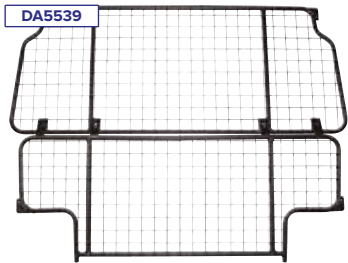

Britpart



Photo by Thomas Pfister



<b>DA4141</b>	Range Rover Classic - 1986 - 1994	Half height	Mesh type	Black
<b>STC8524</b>	Range Rover P38	Half height	Mesh type	Grey
<b>DA1081</b>	Range Rover Sport - 2005 - 2013	Half height	Bar type	Grey
<b>DA5810</b>	Range Rover Sport - 2014 - onwards	Half height	Mesh type	Black
<b>LR007320</b>	Range Rover L322	Half height	Mesh type	Black
<b>DA5806</b>	Range Rover L405	Half height	Mesh type	Black
<b>DA5803</b>	Range Rover Evoque - 5-door	Half height	Mesh type	Black
<b>DA5805</b>	Range Rover Evoque - 3-door	Half height	Mesh type	Black
<b>DA5814</b>	Range Rover Evoque - 2019 onwards	Half height	Mesh type	Black
<b>DA5813</b>	Range Rover Velar	Half height	Mesh type	Grey

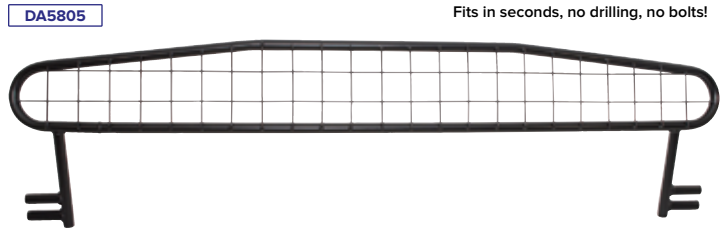
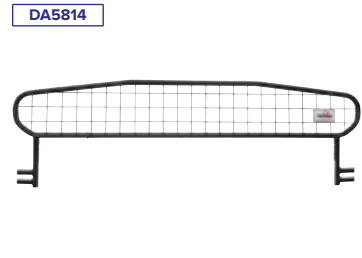
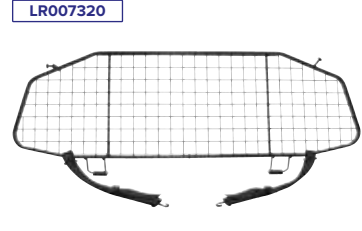
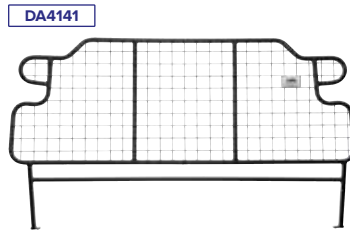

Fits in seconds, no drilling, no bolts!

For more images - [www.britpart.com/dog](http://www.britpart.com/dog)



Photo by Richard Stennett

### Dog Ramp

**Make life easier for you & Rover!**



See it in action at [www.britpart.com/DA1631](http://www.britpart.com/DA1631)



#### DA1631

This handy dog ramp is perfect for dogs who have difficulty jumping into the back of your Land Rover. With an anti-slip coating the ramp is quick and safe to use even in wet conditions. The ramp is perfect for aging & injured dogs as well as puppies and smaller dogs who can't reach! No more hurting your back lifting up your dog!

#### Features

- > Telescopic lightweight design for quick and easy storage
- > Rubber feet to hold ramp in position
- > Catch to hold together when stored
- > Anti-slip coating

#### Specifications

- > Maximum weight capacity - 90kg
- > Weight - 7kg
- > Length compressed - 1,000mm
- > Length extended - 1,850mm
- > Width at widest point - 450mm
- > Deck width - 390mm



# INTERIOR PROTECTION

## Loadspace

### Loadspace Liners - Premium



DA3382



DA4183

Britpart's unique premium loadspace liners are manufactured from a high-specification material. Designed to be durable with an anti-slip, matt look finish. These quality protectors will look after your Land Rover's loadspace for years to come.



DA4169



DA5602



DA5561



DA4829



DA4171



DA5554



DA4170



DA5555



DA4825



DA5556



DA4822



DA5562



DA5557

#### Premium Semi-rigid Loadspace Liners

<b>DA3382</b> <b>NEW</b>	Defender 110 - 2020 onwards - non-PHEV	2½" deep sides	<b>DA5554</b>	Freelander 2	2" deep sides
<b>DA4183</b>	Discovery 1	3" deep sides	<b>DA4170</b>	Range Rover P38	3" deep sides
<b>DA4169</b>	Discovery 2	3" deep sides	<b>DA5555</b>	Range Rover Sport - 2005 - 2013	2" deep sides
<b>DA5602</b>	Discovery 3/Discovery 4	3" deep sides	<b>DA4825</b>	Range Rover Sport - 2014 onwards	Foam with anti-slip finish 2" deep sides
<b>DA5561</b>	Discovery 5 - without rear air-con	2" deep sides	<b>DA5556</b>	Range Rover L322	2" deep sides
<b>DA4829</b>	Discovery Sport	2" deep sides	<b>DA4822</b>	Range Rover L405	Foam with anti-slip finish 2" deep sides
<b>DA4171</b>	Freelander 1	2" deep sides	<b>DA5562</b>	Range Rover Velar - up to 2020	2" deep sides
			<b>DA5557</b>	Range Rover Evoque - 3 & 5 door models	2½" deep sides



Photo by John Walton



Loadspace Liners & Protectors



331401



331481 / 331670 / MTC8294



DA4470



LR005615



STC4629



STC4629LR



EAH500530



DA4503

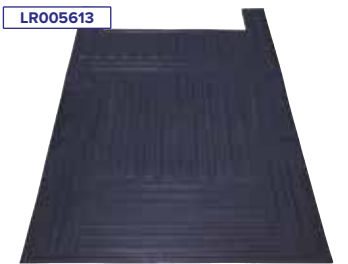

LR005613



LR005040



EAH500520



EAH500540



VPLES0565LR



VPLES0566LR



VPLES0570LR



DA3382

Defender/Series

331401	Series SWB	Loadspace mat	1,177 x 920 x 3mm	Ribbed rubber
331670	Series LWB	Loadspace mat	1,560 x 920 x 3mm	Ribbed rubber
331481 <b>NEW</b>	Series LWB	2nd row mat	1,490 x 460 x 3mm	Ribbed rubber
MTC8294	Defender 90	Loadspace mat	1,250 x 920 x 3mm	Ribbed rubber
DA4470	Defender 90	Loadspace mat	1,230 x 920 x 6mm	Moulded rubber
LR005615	Defender 90	Loadspace mat	1,230 x 890 x 6mm	Moulded rubber
STC4629 <b>NEW</b>	Defender 90 - fits rear floor and wheel arch tops	Loadspace mat	1,230 x 920 x 3mm	Ribbed rubber
STC4629LR	Defender 90 - fits rear floor and wheel arch tops	Loadspace mat	1,230 x 920 x 3mm	Ribbed rubber
EAH500530	Defender 90 Station Wagon - 2007 onwards - 4-seat configuration	Loadspace mat	1,240 x 920 x 3mm	Ribbed rubber
331670	Defender 110 - excludes 3-door commercial	Loadspace mat	1,560 x 920 x 3mm	Ribbed rubber
DA4503	Defender 110 - Hard top & truck cab	Loadspace mat	1,980 x 930 x 5mm with 6mm foam backing	Rubber
LR005613	Defender 110 - 2007 onwards - 5-seat configuration	Loadspace mat	1,230 x 890 x 6mm	Moulded rubber
LR005040	Defender 110 - 2007 onwards - 7-seat configuration	Loadspace mat	1,230 x 890 x 6mm	Moulded rubber
EAH500520	Defender 110 Station Wagon - 2007 onwards - 7-seat configuration	Loadspace mat	1,565 x 920 x 3mm	Ribbed rubber
EAH500540	Defender 110 Station Wagon - 2007 onwards - 5-seat configuration	Loadspace mat	1,565 x 920 x 3mm	Ribbed rubber
VPLES0565LR	Defender 2020 - 90	Loadspace mat with bumper protector		Rubber
VPLES0566LR	Defender 2020 - 110	Loadspace mat with bumper protector		Rubber
VPLES0570LR	Defender 2020 - 110	Loadspace - semi-rigid with 50mm sides and bumper protector		Rubber
DA3382 <b>NEW</b>	Defender 110 - 2020 onwards - non-PHEV	Premium loadspace mat - semi-rigid with 60mm side		Rubber

Keep dirt at bay with a loadspace liner...



STC50434



STC50435



DA4171



LR002516

Freelander				
STC50434	Freelander 1 - 3-door	Loadspace mat		Rubber
STC50435	Freelander 1 - 5-door	Loadspace mat		Rubber
DA4171	Freelander 1	Premium loadspace mat		Semi-rigid with 2" deep sides
LR002516	Freelander 2	Loadspace mat		Rubber
LR002424LR	Freelander 2	Loadspace protector		Semi-rigid with 3" deep sides
VPLFS0244LR	Freelander 2	Loadspace flexible protector		
Note	- Not shown but is similar to image VPLSS0016LR - see Range Rover Sport			
DA5554	Freelander 2	Premium loadspace mat		Semi-rigid with 2" deep sides



LR002424LR



DA5554



# INTERIOR PROTECTION

## Loadspace

### Loadspace Liners & Protectors

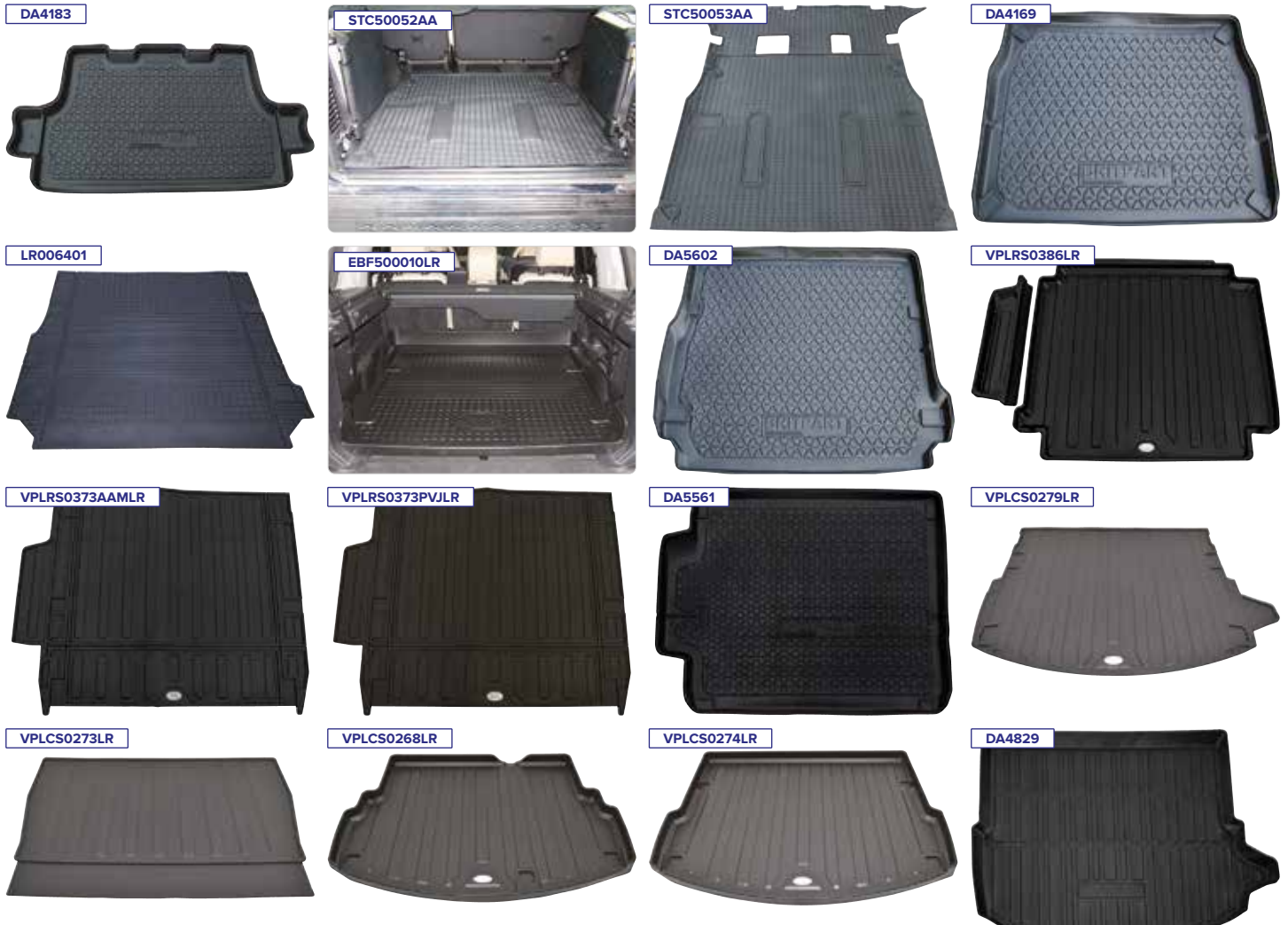

Part Number	Vehicle	Description	Material
DA4183	Discovery 1	Loadspace protector	Semi-rigid with 3" deep sides
STC50052AA	Discovery 2	Loadspace mat - half length	Rubber
STC50053AA	Discovery 2	Loadspace mat - full length	Rubber
DA4169	Discovery 2	Premium loadspace mat	Semi-rigid with 3" deep sides
LR006401	Discovery 3/Discovery 4	Loadspace mat - half length	Rubber
LR006401LR <b>NEW</b>	Discovery 3/Discovery 4	Loadspace mat - half length	Rubber
EBF500010LR	Discovery 3/Discovery 4	Loadspace protector	Semi-rigid with 6" deep sides
VPLAS0015LR	Discovery 3/Discovery 4	Loadspace flexible protector	
<b>Note</b> - Not shown but is similar to Range Rover image - VPLSS0016LR			
DA5602	Discovery 3/Discovery 4	Premium loadspace mat	Semi-rigid with 3" deep sides
VPLRS0386LR	Discovery 5	Loadspace protector	Semi-rigid with 2½" deep sides
VPLRS0373AAML	Discovery 5	Loadspace mat - non-rear air-con - Espresso	Rubber
VPLRS0373PVJLR	Discovery 5	Loadspace mat - non-rear air-con - Ebony	Rubber
DA5561	Discovery 5	Premium loadspace mat	Semi-rigid with 2" deep sides
<b>Note</b> - Not suitable for vehicles with rear air-con			
VPLCS0279LR	Discovery Sport	Loadspace mat - loading compartment	Rubber
VPLCS0273LR	Discovery Sport	Loadspace mat - loading compartment extension	Rubber
VPLCS0268LR	Discovery Sport	Loadspace protector	Semi-rigid with 2" deep sides
<b>Note</b> - Compatible with cargo barrier			
VPLCS0274LR	Discovery Sport	Loadspace protector	Semi-rigid with 2" deep sides
<b>Note</b> - Not compatible with cargo barrier			
DA4829	Discovery Sport	Premium loadspace mat	Semi-rigid with 2" deep sides



### Replacement Loadspace Covers



Replacement loadspace covers with aluminium housing.



DA2863 **NEW**

Discovery 3/Discovery 4

DA2866 **NEW**

Range Rover Sport - Mk1



Loadspace Liners & Protectors



Range Rover

<b>DA4170</b>	Range Rover P38	Premium loadspace mat	Semi-rigid with 3" deep sides
<b>VPLSS0043</b>	Range Rover Sport - 2005 - 2013	Loadspace mat	Rubber
<b>EBF500020LR</b>	Range Rover Sport - 2005 - 2013	Loadspace protector	Semi-rigid with 4" deep sides
<b>VPLSS0016LR</b>	Range Rover Sport - 2005 - 2013	Loadspace flexible protector	
<b>DA5555</b>	Range Rover Sport - 2005 - 2013	Premium loadspace mat	Semi-rigid with 2" deep sides
<b>VPLWS0225</b>	Range Rover Sport - 2014 onwards	Loadspace mat	Rubber
<b>VPLWS0225LR NEW</b>	Range Rover Sport - 2014 onwards	Loadspace mat	Rubber
<b>VPLWS0223LR</b>	Range Rover Sport - 2014 onwards	Loadspace mat - extension	Rubber
<b>VPLWS0224LR</b>	Range Rover Sport - 2014 onwards	Loadspace protector	Semi-rigid with 4" deep sides
<b>VPLWS0226LR</b>	Range Rover Sport - 2014 onwards	Loadspace protector	Semi-rigid with 2" deep sides
<b>DA4825</b>	Range Rover Sport - 2014 onwards	Premium loadspace mat	Semi-rigid with 2" deep sides
<b>LR003894</b>	Range Rover L322	Loadspace mat	Rubber
<b>EBF000040LR</b>	Range Rover L322	Loadspace protector	Semi-rigid with 6" deep sides
<b>DA5556</b>	Range Rover L322	Premium loadspace mat	Semi-rigid with 2" deep sides
<b>VPLGS0263LR</b>	Range Rover L405	Loadspace protector	Semi-rigid with 2" deep sides
<b>VPLGS0260 NEW</b>	Range Rover L405	Loadspace mat	Rubber
<b>DA4822</b>	Range Rover L405	Premium loadspace mat	Semi-rigid with 2" deep sides
<b>VPLVS0091</b>	Range Rover Evoque	Loadspace mat	Rubber
<b>VPLVS0090LR</b>	Range Rover Evoque	Loadspace flexible protector	
	<b>Note</b> - Not shown but is similar to Range Rover image - VPLSS0016LR		
<b>DA5557</b>	Range Rover Evoque	Premium loadspace mat	Semi-rigid with 2" deep sides
<b>DA5562</b>	Range Rover Velar - up to 2020	Premium loadspace mat	Semi-rigid with 2" deep sides



Photo by Bogdan Muscalu

Keep dirt at bay with a loadspace liner...



# INTERIOR PROTECTION

## Mats

### Rubber Mats



#### Heavy-duty Defender Rubber Mats With Foam Backing

<b>BTR7895</b>	Defender - LT77 gearbox	Front floor left hand
<b>BTR7896</b>	Defender - LT77 gearbox	Front floor right hand
<b>BTR7897</b>	Defender - 1993 onwards	Front floor left hand
<b>BTR7898</b>	Defender - 1993 onwards	Front floor right hand
<b>DA4501</b>	Defender - LT77 gearbox	Front right & left hand
	Contains - BTR7895 & BTR7896	
<b>DA4502</b>	Defender - 1993 onwards	Front right & left hand
	Contains - BTR7897 & BTR7898	

#### Quality Fitted Rubber Mats

<b>DA4422</b>	Series 2/Series 3	RHD/LHD	Front	Pair
<b>DA4423</b>	Defender - all models from XA159807	RHD/LHD	Front	Pair
<b>VPLDS0676</b>	Defender - all models from XA159807	RHD/LHD	<b>NEW</b> Front	Pair
<b>VPLDS0675</b>	Defender - 110 - 1987 - 2006	RHD/LHD	2nd row	Single
<b>VPLDS0677</b>	Defender - 110 - 2007 onwards	RHD/LHD	2nd row	Single
<b>VPLDS0674</b>	Defender - from XA159807	RHD/LHD	<b>NEW</b> Front	Pair
<b>LR005039</b>	Defender - up to BA999999	RHD/LHD	Front	Pair
<b>VPLDS0147</b>	Defender - from CA000001	RHD/LHD	Front	Pair
<b>DA4426</b>	Discovery 1	RHD	Front	Pair
<b>DA4427</b>	Discovery 1	RHD/LHD	Rear	Pair
<b>DA4424</b>	Discovery 2	RHD/LHD	Front	Pair
<b>VPLJS0685</b>	Discovery 2	RHD/LHD	<b>NEW</b> Front & rear	Pair
<b>DA4425</b>	Discovery 2	RHD/LHD	Rear	Pair
<b>DA4802</b>	Discovery 3/Discovery 4	RHD	Front & rear	Set
<b>DA4803</b>	Discovery 3/Discovery 4	LHD	Front & rear	Set
<b>DA4819</b>	Discovery 3/Discovery 4		3rd row contour floor mat	
<b>DA4858</b>	Discovery 5	RHD	Front & rear	Set
<b>DA4859</b>	Discovery 5	LHD	Front & rear	Set
<b>DA4827</b>	Discovery Sport - up to KH & KT999999	RHD	Front & rear	Set
<b>DA4828</b>	Discovery Sport - up to KH & KT999999	LHD	Front & rear	Set
<b>DA4832</b>	Discovery Sport		3rd row contour floor mat	



*Keep your Land Rover interior clean with a set of Britpart fitted rubber mats.*

For more mat images - [www.britpart.com/mats](http://www.britpart.com/mats)



### Rubber Mats



#### Quality Fitted Rubber Mats

<b>DA4428</b>	Freelander 1	RHD	Front	Pair
<b>DA4429</b>	Freelander 1	RHD/LHD	Rear	Pair
<b>DA4800</b>	Freelander 2	RHD	Front & rear	Set
<b>DA4801</b>	Freelander 2	LHD	Front & rear	Set
<b>DA4430</b>	Range Rover P38	RHD	Front	Pair
<b>DA4431</b>	Range Rover P38	RHD/LHD	Rear	Pair
<b>DA4804</b>	Range Rover Sport - 2005 - 2013	RHD	Front & rear	Set
<b>DA4805</b>	Range Rover Sport - 2005 - 2013	LHD	Front & rear	Set
<b>DA4823</b>	Range Rover Sport - 2014 onwards	RHD	Front & rear	Set
<b>DA4824</b>	Range Rover Sport - 2014 onwards	LHD	Front & rear	Set
<b>DA4806</b>	Range Rover L322 - up to 6A999999	RHD	Front & rear	Set
<b>DA4807</b>	Range Rover L322 - up to 6A999999	LHD	Front & rear	Set
<b>DA4808</b>	Range Rover L322 - 7A000001 onwards	RHD	Front & rear	Set
<b>DA4809</b>	Range Rover L322 - 7A000001 onwards	LHD	Front & rear	Set
<b>DA4820</b>	Range Rover L405 - 2013 onwards	RHD	Front & rear	Set
<b>DA4821</b>	Range Rover L405 - 2013 onwards	LHD	Front & rear	Set
<b>DA4860</b>	Range Rover Velar	RHD	Front & rear	Set
<b>DA4861</b>	Range Rover Velar	LHD	Front & rear	Set
<b>DA4812</b>	Range Rover Evoque - 2 & 4 door	RHD	Front & rear	Set
<b>DA4813</b>	Range Rover Evoque - 2 & 4 door	LHD	Front & rear	Set

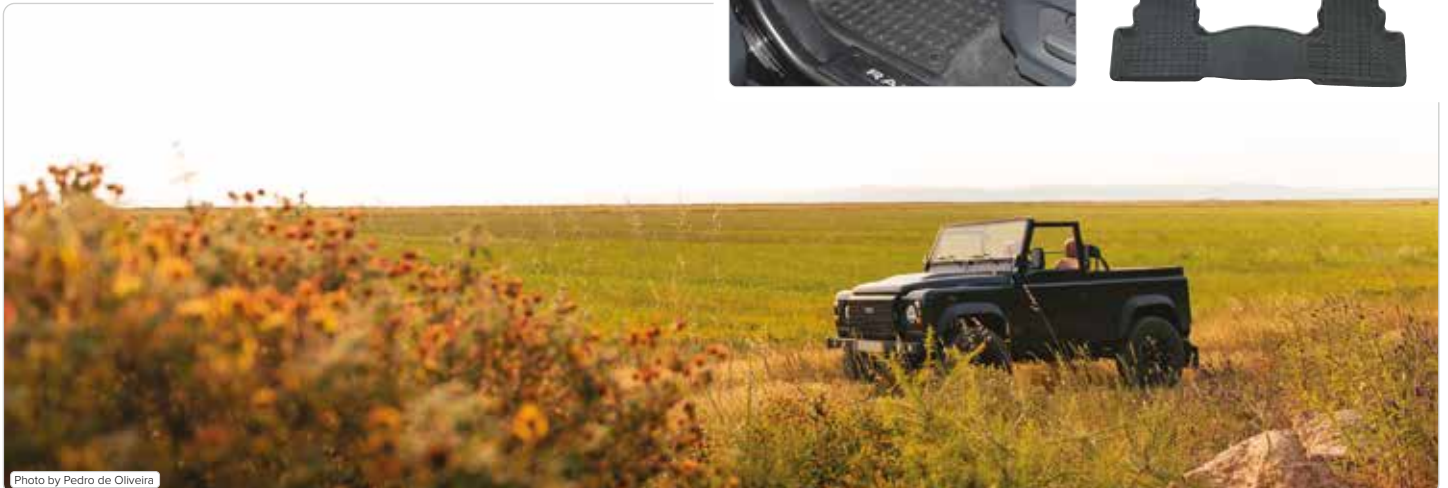



# INTERIOR PROTECTION

## Mats

### Carpet Mat Sets



**DA4022BLACK**  
 Carpet set with rubber backing  
 Defender - up to 2007  
 Front  
 Black



### Premium Mat Sets



LR002485LR

VPLRS0332PVJLR

VPLES0668LR

#### Carpet Mats With Rubber Backing

<b>VPLDS0241LR NEW</b>	Defender 110 - 2007 - 2016 - from DA000001	Front & rear set	RHD/LHD	Ebony
<b>VPLFS0245PVJ</b>	Freelander 2	Front & rear contour set	RHD	Ebony
<b>LR002485LR</b>	Freelander 2	Front & rear contour set	RHD	Alpaca
<b>LR006433LR</b>	Discovery 3	Front & rear contour set	LHD	Alpaca
<b>EAH5000155MSLR</b>	Range Rover Sport - 2005 - 2013	Front & rear floor set	LHD	Alpaca
<b>VPLWS0374PVJLR</b>	Range Rover Sport - 2014 onwards	Front & rear floor set	RHD	Ebony
<b>VPLWS0375PVJLR</b>	Range Rover Sport - 2014 onwards	Front & rear floor set	LHD	Ebony
<b>EAH000310LUPLR</b>	Range Rover L322 - up to 6A	Front & rear contour set	LHD	Aspen
<b>EAH000300SUN</b>	Range Rover L322 - up to 6A	Front & rear contour set	RHD	Sand
<b>EAH500290LUPLR</b>	Range Rover L322 - from 7A	Front & rear contour set	LHD	Aspen
<b>EAH500290PVALR</b>	Range Rover L322 - from 7A	Front & rear contour set	LHD	Jet

#### Rubber Mats

<b>VPLDS0674LR NEW</b>	Defender 1987 - 2006	Front mat set	RHD/LHD	Black
<b>VPLDS0676LR NEW</b>	Defender 2007 - 2016 - up to BA999999	Front mat set	RHD/LHD	Black
<b>VPLDS0686LR NEW</b>	Defender 2007 - 2016 - up to WA159806	Front mat set	RHD/LHD	Black
<b>VPLDS0147LR NEW</b>	Defender 2007 - 2016 - from CA000001	Front mat set	RHD/LHD	Black
<b>VPLDS0675LR NEW</b>	Defender 1987 - 2006 110 Station Wagon	2nd row mat set	N/A	Black
<b>VPLDS0677LR NEW</b>	Defender 2007 - 2016 110 Crew cab pickup	2nd row mat set	N/A	Black
<b>VPLES0665LR NEW</b>	Defender 2020 - 90	Front & rear deep sided set	RHD	Black
<b>VPLES0667LR</b>	Defender 2020 - 110 - 5+2 seats	Front & rear deep sided set	RHD	Black
<b>VPLES0553LR</b>	Defender 2020 - 110 - 5+2 seats	Front & rear deep sided set	LHD	Black
<b>VPLES0666LR</b>	Defender 2020 - 110 - 5-seat	Front & rear deep sided set	RHD	Black
<b>VPLES0668LR</b>	Defender 2020 - 110 - 5-seat	Front & rear deep sided set	LHD	Black
<b>STC50402AALR NEW</b>	Freelander 1	Front & rear	LHD	Black
<b>VPLFS0683LR</b>	Freelander 2	Front & rear contour set	RHD	Black
<b>VPLFS0234LR</b>	Freelander 2	Front & rear contour set	LHD	Black
<b>LR006237LR</b>	Discovery 3/Discovery 4	Front & rear contour set	RHD	Black
<b>LR006238LR</b>	Discovery 3/Discovery 4	Front & rear contour set	LHD	Black
<b>EAH500100PMALR</b>	Discovery 3/Discovery 4	3rd row floor mat	N/A	Black
<b>EAH500052PMALR</b>	Discovery 3	Front & rear floor set	RHD	Black
<b>VPLRS0332AAMLR</b>	Discovery 5	Front & rear floor set	RHD	Espresso
<b>VPLRS0332PVJLR</b>	Discovery 5	Front & rear floor set	RHD	Ebony
<b>VPLRS0333PVJLR</b>	Discovery 5	Front & rear floor set	LHD	Ebony
<b>VPLCS0278LR</b>	Discovery Sport	Front & rear contour set	RHD	Black
<b>VPLCS0281LR</b>	Discovery Sport	Front & rear contour set	LHD	Black
<b>VPLCS0280LR</b>	Discovery Sport	3rd row floor mat	N/A	Black
<b>VPLSS0679LR</b>	Range Rover Sport - 2005 - 2013	Front & rear contour set	RHD	Black
<b>VPLAS0198LR</b>	Range Rover Sport - 2005 - 2013	Front & rear contour set	LHD	Black
<b>VPLWS0660LR</b>	Range Rover Sport - 2014 onwards	Front & rear contour set	RHD	Black
<b>VPLWS0190LR</b>	Range Rover Sport - 2014 onwards	Front & rear contour set	LHD	Black
<b>VPLPS0684LR</b>	Range Rover Classic	Front & rear floor set	RHD/LHD	Black
<b>EAH500320PMALR</b>	Range Rover L322	Front & rear contour set	RHD	Black
<b>VPLMS0083LR NEW</b>	Range Rover L322	Front & rear contour set	RHD	Black
<b>VPLMS0680LR</b>	Range Rover L322	Front & rear contour set	LHD	Black
<b>VPLMS0681LR NEW</b>	Range Rover L322	Front & rear contour set	LHD	Black
<b>VPLMS0682LR NEW</b>	Range Rover L322	Front & rear contour set	LHD	Black
<b>EAH000261PMALR</b>	Range Rover L322	Front & rear floor set	RHD	Black
<b>EAH000271PMALR</b>	Range Rover L322	Front & rear floor set	LHD	Black
<b>VPLGS0149LR</b>	Range Rover L405 - SWB	Front & rear contour set	RHD	Black
<b>VPLGS0444PVJLR</b>	Range Rover L405 - SWB <b>NEW</b>	Front & rear contour set	LHD	Black
<b>VPLY0413LR</b>	Range Rover Velar	Front & rear contour set	LHD	Ebony
<b>VPLY0414LR</b>	Range Rover Velar	Front & rear contour set	RHD	Ebony
<b>LR045096LR</b>	Range Rover Evoque	Front & rear contour set	RHD	Black
<b>VPLZS0490LR</b>	Range Rover Evoque - 2019 onwards - manual	Front & rear contour set	RHD	Black
<b>VPLZS0701LR</b>	Range Rover Evoque - 2019 onwards - auto	Front & rear contour set	RHD	Black
<b>VPLZS0491LR</b>	Range Rover Evoque - 2019 onwards	Front & rear contour set	LHD	Black

Premium protection for your Land Rover



Photo by Keith Upton



Acoustic Mat Systems

DA1744GREY



DA1745BLACK



DA1746GREY



Add less noise to your Defender...

DA1747BLACK



DA1744GREY



DA1745BLACK



DA1746GREY



DA1747BLACK



**DA1744BLACK NEW**

Series 2, 2A & 3

**DA1744GREY**

Series 2, 2A & 3

**DA1745BLACK**

Ninety/One Ten & Defender - LT77 transmission

**DA1745GREY**

Ninety/One Ten & Defender - LT77 transmission

**DA1746BLACK**

Defender - R380 transmission

**DA1746GREY**

Defender - R380 transmission

**DA1747BLACK**

Defender - Puma 2.4

**DA3473BLACK NEW**

Seat box cover only

Defender - R380 transmission & Defender - Puma 2.4

The acoustic mat system has been designed to drastically reduce noise entering the cabin of your Land Rover. Made from cast dense polyurethane, the mat is built to industrial standards for reducing noise levels often found in construction equipment. It provides a hard wearing, durable surface that can withstand constant daily use & is easy to clean. A custom fit mat drastically reduces noise entering the cabin and panel reverberation.

**Q Does the acoustic mat system fit Lightweights?**

A. It has been fitted to lightweights but it wasn't designed to and it's a tricky job. It involves a lot of cutting.

**Q What about seat box lids?**

A. The seat box mat has witness marks on its under side corresponding to all the features of the seat box. It can be cut to your individual requirements using a HD craft knife.

**Q What about the trapped water?**

A. Anything you put on the floor will trap water/condensation, even the new mats supplied by Land Rover. As the acoustic mat system is a hard wearing secondary surface you now have the ability to rustproof the inner surfaces of the floor. You will find that it is only a small amount of water and does dry out.

**Q What does the foam do?**

A. There is closed cell foam in the area of the footwells and floor panels. It is there to take some weight out of the mat and provide more comfort under foot. The foam has very little acoustic properties.

**Q How heavy is the system?**

A. Approximately 25 kilos of dense polyurethane which is the barrier to noise. This is equivalent to having a spare wheel and tyre spread over the floor area. This is why it is so effective.

**Q How effective is the mat system?**

A. It would be impossible to quote the reduction in decibels as each application would be different. In testing we used a SWB 2A with a NA 2.5 freight Rover diesel engine. The owner can now have a sensible conversation at full speed!

**Q What if I want to get to the gearbox?**

A. In the good old Haynes manual tradition, removal is the reversal of fitting. It takes about 5-10 minutes to remove. You shouldn't ever need to remove the seat box mat or bulkhead mat, unless you wish to transfer them to a different vehicle.

**Q What if my mats are distorted?**

A. In most cases, over time it will return to its cast shape. Try to warm it to speed this up.

**Easy to Fit & Clean**

- > Reduces noise - the complete system negates the need for engine and gearbox blankets
- > Hard wearing - harder wearing than rubber - it will probably outlast your Land Rover
- > Easy to fit - no glue and is transferable
- > Easy to clean - can be hosed out
- > Insulation - provides insulation to keep heat out (or in)
- > Inert - mat will not rot or hold water unlike felt or carpet
- > Resistant - material is fuel, oil, water and sunlight resistant
- > Fire retardant
- > Recyclable



**DA1756BLACK**

Defender/Series

The kick plate on the Defender is prone to damage and can lead to the inside of your Defender looking tatty and tired. Protect that edge and smarten up your interior by fitting a pair of these panels.

- > Supplied in pairs
- > Can be trimmed to fit Series vehicles
- > To be paired with Acoustic Mat Systems
- > Easy to fit & easy to clean
- > Inert - will not rot or hold water
- > Resistant - material is fuel, oil, water and sunlight resistant
- > Fire retardant



# INTERIOR PROTECTION

## Waterproof Seat Covers

### Waterproof Seat Covers - Britpart

BLACK

BLUE

GREEN

GREY

SAND

Colour swatches for illustrative purposes only.

#### Defender

Defender - up to 2007 - 3 Seats - Front

DA2815BLACK

DA2815GREY

Covers in kit - 3 x full seat (excludes headrest covers)

Defender - 2007 onwards - Front

DA2818BLACK

DA2818GREY

Covers in kit - 2 x full seat; 2 x headrest

Defender 110 Station Wagon - up to 2007 - Forward facing 2nd row - 60/40

DA2816BLACK

DA2816GREY

Covers in kit - 1 x twin seat back & base & 1 x single seat back & base. Note - Will fit 110 Crew Cab with minor modification to seat covers.

Defender 110 Station Wagon - up to 2007 - Rear inward facing bench

DA2817GREY

Covers in kit - 2 x bench-seat back & base. Note - For 1,200mm long seat.

Defender 110/130 - 2007 onwards - Rear 2nd row forward facing - 60/40 split

DA2828BLACK

Covers in kit - 1 x twin seat back & base & 1 x single seat back & base

#### Discovery

Discovery 1 - Front

DA2807BLACK

DA2807BLUE

DA2807GREEN

DA2807GREY

DA2807SAND

Covers in kit - 2 x full seat. Note - Discovery 1 seat covers will not fit vehicles with leather seats and 200Tdi's with pocket on rear seat.

Discovery 1 - Rear

DA2808BLUE

DA2808GREEN

DA2808GREY

Covers in kit - 1 x two-seat back & base; 1 x one-seat back & base. Note - Discovery 1 seat covers will not fit vehicles with leather seats and 200Tdi's with pocket on rear seat.

Discovery 1 - Boot

DA2809BLUE

DA2809GREY

Covers in kit - 2 x full seat. Note - Discovery 1 seat covers will not fit vehicles with leather seats and 200Tdi's with pocket on rear seat.

Discovery 2 - Front

DA2800BLACK

DA2800BLUE

DA2800GREEN

DA2800GREY

Covers in kit - 2 x full seat; 2 x headrest; 2 x armrest.

Discovery 2 - Rear

DA2801GREY

DA2801SAND

Covers in kit - 1 x full seat; 1 x two-seat back & base; 1 x armrest; 3 x headrest

Discovery 2 - Boot

DA2802GREEN

DA2802GREY

Covers in kit - 2 x full seat; 2 x roof headrest.

Discovery 3 - Front

DA2822BLACK

DA2822SAND

Covers in kit - 2 x full seat; 2 x headrest; 2 x armrest. Note - Suitable for vehicles with side airbags.

Discovery 3 - Rear - 35/30/35 split

DA2823SAND

Covers in kit - 3 x full seat; 3 x headrests.

Discovery 4 - Front

DA2832BLACK

Covers in kit - 2 x full seat; 2 x headrest; 2 x armrest. Note - Suitable for vehicles with side airbags.



**A fantastic way to protect your Land Rover seats with these Britpart waterproof covers.**

- > An extensive range of quality and stylish waterproof seat cover sets.
- > Front and rear sets available with headrests and armrests included in the Range Rover and Freelander range.
- > Rear inward facing sets are also available for the 7-seater Discovery models.
- > The hard-wearing washable covers are made from waterproof woven polyester with a PVC backing.
- > Snug fit covers available in stylish colours.
- > Easy to put on the seats and just as easy to remove again.



### Waterproof Seat Covers - Britpart

Colour swatches for illustrative purposes only.

BLACK

BLUE

GREEN

GREY

SAND

#### Freelander

Freelander 1 - 3 Door - Front

Covers in kit - 2 x back, base & headrest. Note - Not suitable for 2004 onwards facelift models.

DA2810BLACK

Freelander 1 - 5 Door - Front

Covers in kit - 2 x back, base & headrest. Note - Not suitable for 2004 onwards facelift models.

DA2811GREY

Freelander 1 - 3 & 5 Door - Rear 60/40 split without armrest

Covers in kit - 1 x two-seat back & base; 1 x one-seat back & base; 3 x headrest. Note - Not suitable for 2004 onwards facelift models.

DA2813BLACK

DA2813GREEN

DA2813GREY

Freelander 1 - 3 & 5 Door - Rear 60/40 split with armrest

Covers in kit - 1 x two-seat back & base; 1 x one-seat back & base; 3 x headrest. Note - Not suitable for 2004 onwards facelift models.

DA2814GREY

Freelander 1 - 3 Door Sport - 2 Rear Seats

Covers in kit - 2 x back, base & headrest. Note - Not suitable for 2004 onwards facelift models.

DA2812BLUE

DA2812GREEN

DA2812GREY

Freelander 2 - Front

Covers in kit - 2 x full seat; 2 x headrest; 2 x armrest. Note - Suitable for use with airbags but not vehicles without armrests.

DA2821BLACK

Freelander 2 - Rear

Covers in kit - 1 x two-seat back & base; 1 x one-seat back & base; 3 x headrest & 1 x armrest. Note - Not suitable for vehicles with leather seats.

DA2831BLACK

#### Range Rover

Range Rover Classic - 4 Door - Front

Covers in kit - 2 x back, base, armrest & headrest.

DA2803BLACK

DA2803BLUE

DA2803GREY

DA2803SAND

Range Rover Classic - 4 Door - Rear

Covers in kit - 1 x two-seat back & base; 1 x one-seat back & base; 3 x armrest.

DA2804BLUE

DA2804GREEN

DA2804GREY

DA2804SAND

Range Rover P38 - Front

Covers in kit - 2 x full seat, headrest & armrest. Note - Not suitable for vehicles with rear air bags mounted in the front seats or seats with electric headrests.

DA2805GREY

Range Rover Sport - 2005 - 2009 - Front

Covers in kit - 2 x full seat; 2 x headrest; 2 x armrest.

DA2819BLACK

DA2819SAND

Range Rover Sport - 2005 - 2009 - Front - vehicles with electric headrests

Covers in kit - 2 x full seat; 2 x headrest; 2 x armrest.

DA2825SAND

Range Rover Sport - 2005 - 2009 - Rear

Covers in kit - 1 x two-seat back & base; 1 x one-seat back & base; 3 x headrest & 3 x armrest

DA2829BLACK

Range Rover Sport - 2010 - 2013 - Front

Covers in kit - 2 x full seat, headrest & armrest

DA2839BLACK

DA2839SAND

Range Rover L322 - 2007 - 2009 - Rear

Covers in kit - 1 x one-seat base; 1 x two-seat base; 2 x back; 1 x middle back; 2 x headrest

DA2830BLACK

Plenty more images available to view at

[www.britpart.com/seatcovers](http://www.britpart.com/seatcovers)



DA2813GREEN



DA2821BLACK



DA2803GREY



### Waterproof Seat Covers - Other

#### Land Rover Seat Covers

LR005059LR	Freelander 2	Front	Sand	
VPLAS0130PVJLR NEW	Discovery 4	Front	Sand	
VPLRS0335PVJLR	Discovery 5	Front	Black	
VPLCS0291PVJLR	Discovery Sport	Front	Black	
VPLCS0292PVJLR	Discovery Sport	2nd row	Black	
VPLCS0293PVJLR	Discovery Sport	3rd row	Black	
VPLCS0291SVALR	Discovery Sport	Front	Almond	
VPLCS0292SVALR	Discovery Sport	2nd row	Almond	
VPLCS0293SVALR	Discovery Sport	3rd row	Almond	
HBD000320JMNLR	Range Rover L322 - 02 - 06	Front		Navy
HBD000320LJPLR	Range Rover L322 - 02 - 06	Front		Aspen
VPLMS0085PVJLR	Range Rover L322 - 02 - 06	Front		Black
VPLMS0085SVALR	Range Rover L322 - 02 - 06	Front		Almond
VPLWS0228SVALR	Range Rover Sport - Mk2	Front		Almond
VPLWS0229SVALR	Range Rover Sport - Mk2	Rear - 60/40 split		Almond
VPLGS0154SVALR NEW	Range Rover L405	Front		Almond
VPLGS0155PVJLR NEW	Range Rover L405	Rear - 60/40 power fold		Black
VPLGS0154PVJLR	Range Rover L405	Front		Black

#### Inka Seat Covers

These stylish seat cover kits also include headrest and armrest covers (where applicable) with a fitting guide. The kits are waterproof, fire retardant and washable.

LR005058LR	Freelander 2	Front	Aspen
VPLSS0026PVJ	Range Rover Sport - Mk1	Front	Black
VPLWS0228PVJ	Range Rover Sport - Mk2	Front	Black
VPLWS0230SVA	Range Rover Sport - Mk2	Rear - 60/40 power fold	Almond
VPLMS0087SVA	Range Rover L322 - 10 - 12	Rear	Sand
VPLMS0087PVJ	Range Rover L322 - 10 - 12	Rear	Black

#### Range Rover Evoque - Mk1

VPLVS0070PVJ	3-door less rear entertainment	Front	Black
VPLVS0071PVJ	5-door less rear entertainment	Front	Black
VPLVS0072PVJ	2 individual 2nd row seat	Rear	Black
VPLVS0077PVJ	2nd row 60/40 folding	Rear	Black

#### 08500021 ARB Universal Seat Cover

Black siding & an ARB centre logo which is located within a ventilated grey centre section

- > One size fits almost all seats, including buckets
- > Quick and simple design allows for fast fitment in just seconds
- > Easy to store when folded and tucked away
- > Provides superior protection against dirt and general wear
- > Heavy duty and washable polyester provides a long term solution

UK only





# INTERIOR PROTECTION

## Loadspace Organisation

### Loadspace Retention Kits



**VPLWS0589LR**  
Restricts the movement of goods in the rear of the vehicle. Contents - 1 x floor net & 2 x ratchet straps  
**VPLWS0589LR**  
Discovery 5/Range Rover Sport - 2014 onwards  
Range Rover L322 - 2010 - 2012/Range Rover L405  
**VPLCS0269**  
Discovery 3/Discovery 4/Discovery Sport Range Rover Evoque - Mk1 & Mk2

### Loadspace Nets



**LR017770LR**  
A convenient way of storing luggage.  
**LR017770LR**  
Range Rover L322  
Contents - 2 x nets



**VPLCS0588LR**  
Umbrella not included  
**VPLCS0588LR**  
Freelander 2/Discovery Sport/Range Rover Evoque - Mk 1  
Contents - 1 x net. Can be used in two positions within the loadspace.

### Boot Organiser



**VPLVS0175LR NEW**  
Universal Land Rover boot organiser retains small items in the loadspace and can easily be folded away when not in use.

### Tie Down Points



**DA1170**  
SVX style cargo tie down point  
Smart & easy to fit  
Single

### Umbrella Holder



Umbrella not included  
A convenient way of storing your umbrella.  
**VPLGS0153LR** Range Rover L405  
Contents - 2 x holders

### Ratchet Straps & Cam buckle Tie Downs



**DA1267**  
Ratchet Straps  
**DA1267**  
2m - pair



**RT11A**  
**CT02**  
**ARB Cargo Gear Straps**  
**RT11A** 32mm x 3m  
**RT06A** 50mm x 5m  
High quality polyester webbing finished in safety orange with reflective branding. Zinc plated for longevity and corrosion resistance. Rubber handles & silicone coated cam sleeves. Storage bag included. Single

**ARB Cam Buckle Tie Downs**  
**CT02** 25mm x 1.8m  
**CT02A NEW** 25mm x 3.0m  
Provide a quick and easy solution to securing your load to racks, trailers and cargo areas. Polyester webbing with zinc alloy cam buckle. Lashing capacity - 340kg. Pack of 2.

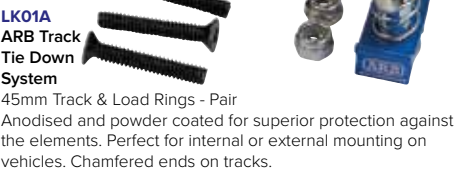

**LK01A**  
**ARB Track Tie Down System**  
45mm Track & Load Rings - Pair  
Anodised and powder coated for superior protection against the elements. Perfect for internal or external mounting on vehicles. Chamfered ends on tracks.

### Loadspace Luggage Rails



**VPLSS0138LR**  
Range Rover Sport - 2010 - 2013

### Cargo Organisers



**10100375**  
**Small** - 400 W x 160 D x 180mm H  
**10100371** With ID label holder  
**10100377 NEW** With PVC lid



**10100378**  
**Medium** - 600 W x 200 D x 180mm H  
**10100372** With ID label holder  
**10100378 NEW** With PVC lid



**10100379**  
**Large** - 400 W x 400 D x 180mm H  
**10100373** With ID label holder  
**10100379 NEW** With PVC lid



**10100375**  
**ARB Cargo Dividers**  
**10100374** 4 pack  
Suitable for medium Cargo Organiser  
**10100375** 2 pack  
Suitable for large Cargo Organiser

**ARB Cargo Organisers**  
Finding places to put objects of all shapes and sizes to maximize your space is a challenge and an art form. Having a place for everything and everything in its place removes the guesswork of finding your cargo when you pull up at your next destination. The solution is these ARB Cargo Organisers.

- > 600D PU coated heavy-duty Oxford nylon.
- > Durable webbing handles making it easy to move or carry.
- > Zippered top to keep contents secure and clean.
- > ID label holders or clear PVC top to help identify contents quickly.
- > Removable dividers that are movable and removable - for large & medium sizes.
- > Additional dividers sold separately.
- > Folds flat when not in use - easy to store and maximize space.
- > Matches colour and styling of the ARB Cargo product range.
- > Easy clean interior with PU coated nylon.



**4X4 ACCESSORIES**

ARB products available in the UK only.



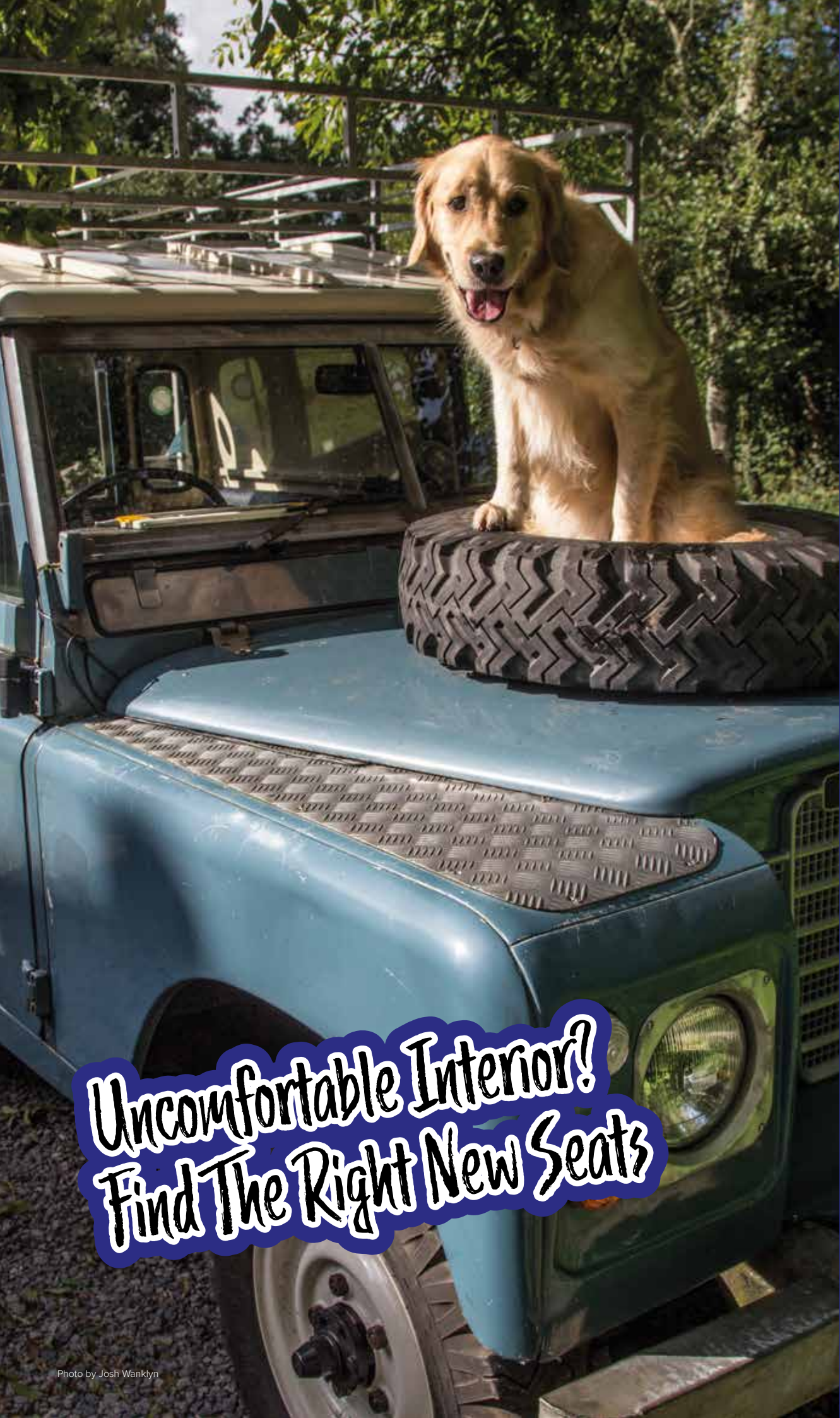

# SEATS & TRIM

**Uncomfortable Interior?  
Find The Right New Seats**



# SEATS & TRIM

## Seats

### Defender - Front Seats

Black Seats		
DA4028	Seat cover	Outer base
DA4041	Seat cover	Outer back
MUC8414 <b>NEW</b>	Seat cover	Outer back
DA4589	Seat cover	Centre base - Td5 onwards
DA4590	Seat cover	Centre back - 1990 onwards
MWC3302	Seat	Right hand back
MWC3303	Seat	Left hand back
MWC4535	Seat	Outer base
Grey Seats		
DA4029	Seat cover	Outer base
DA4042	Seat cover	Outer back
DA4591	Seat cover	Centre base - Td5 onwards
DA4592	Seat cover	Centre back - 1990 onwards
BTR1759LCS	Seat cover with map pocket	Outer back
MWC9844LCS	Seat	Right hand back
MWC9843LCS	Seat	Left hand back
MWC5670LCS	Seat	Outer base
MXC3257LCS	Left hand assembly	Less headrest
Vinyl Twill Seats		
AWR5701RPI	Seat cover	Outer base
AWR5702RPI	Seat cover	Outer back
DA4593	Seat cover	Centre base - Td5 onwards
DA4594	Seat cover	Centre back - 1990 onwards
AWR5698RPI	Seat	Right hand back
AWR5699RPI	Seat	Left hand back
AWR5700RPI	Seat	Outer base
HAD501820RPI	Right hand assembly	Less headrest
HAD501870RPI	Left hand assembly	Less headrest

Techno Style Seats		
HAD501870LOY	Seat assembly with map pocket	Right hand side
HAD501850LOY	Seat assembly with map pocket	Left hand side
HAG100970LOY	Base	
HCA106010LOY	Cover base	
DA4595	Seat cover	Centre base - Td5 onwards
DA4596	Seat cover	Centre back - 1990 onwards
HAI101400LOY	Seat assembly - no pockets	Right hand back
HAI101410LOY	Seat assembly - no pockets	Left hand back
HBA106190LOY	Seat cover - no pocket	Back
HBA106180LOY	Seat cover - with pocket	Back

NAS Seats - Vinyl twill main panel with black vinyl borders		
DA5693 <b>NEW</b>	Seat	Right hand back
DA5694 <b>NEW</b>	Seat	Left hand back
DA5638 <b>NEW</b>	Seat	Base

Foam, Runners & Finishers		
349943	Plastic corner capping for standard Defender & Series seat bases	
DA4031	Seat foam	Outer base
DA4055	Seat foam	Outer back - up to 2007
HGA500500	Seat foam	Back - 2007 onwards
DA4057	Seat foam	Centre base
DA4056	Seat foam	Centre back
DA3390 <b>NEW</b>	Headrest foam	Single - up to 2007
MTC9967	Front seat edge finisher	
LR045271	Runner & sub-frame	Right hand side
LR045272	Runner & sub-frame	Left hand side

*All products leaving the Trim Shop are produced to the highest standards*



*The highly skilled team in the Britpart Trim Shop make a wide range of seats and seat covers for Land Rover vehicles by hand. The material arrives in vast reams and has to be cut with great precision before being stitched together and then assembled into seat bases, seat backs, seat benches etc. In keeping with the Britpart philosophy, all products leaving the Trim Shop are produced to the highest standards and meet with the strictest safety regulations.*

For many more pictures of our seats and trim - [www.britpart.com/seats](http://www.britpart.com/seats)

### Defender Sport Seats

DA1895	Defender Sports Seats
Pair	
DA2827	Defender Heated Sports Seats
Pair	
DA2778	Defender seat mounting plates
Pair	

**HEATED  
VERSION AVAILABLE**

*Stylish and comfortable sports seat for your Defender.*

*The attractive diamond pattern is a great enhancement to your Defender cab!*

#### Heated Pair

*There are two switches provided for the driver and passenger seats which allow the heat output to be altered to the two different settings. A ready-made cable set connects the switches to the 12V on-board power supply to the heat the pads.*





## Series - Front Seats

Black Seats		
349967	Seat base	Standard outer
320699	Seat base - adjustable	Standard outer
320726	Seat base	Standard centre
320698	Seat back - bolt fitment - adjustable	Standard outer
MUC1520	Seat back - pin fitment	Standard outer
MUC1488	Seat back - pin fitment	Standard centre
DA4305	Standard seat kit	
<b>Note</b> - Kit contains - 2 x 349967; 2 x MUC1520; 1 x 320726 & 1 x MUC1488		
MRC6980	Seat base	Deluxe outer
MRC6982	Seat back	Deluxe outer
MRC6982H	Seat back with headrest	Deluxe outer
MRC6985	Seat base	Deluxe centre
MTC3181	Seat back	Deluxe centre
DA4298	Deluxe seat kit	
<b>Note</b> - Kit contains - 2 x MRC6982; 2 x MRC6980; 1 x MTC3181 & 1 x MRC6985		
349514 NEW	2nd Row	Back
349515 NEW	2nd Row	Base

Grey Seats		
349967LCS NEW	Seat base	Standard outer
320726LCS NEW	Seat base	Standard centre
MUC1520LCS NEW	Seat back - pin fitment	Standard outer
MUC1488LCS NEW	Seat back - pin fitment	Standard centre

County Grey Seats		
MRC6980CG	Seat base	Deluxe outer
MRC6982CG	Seat back	Deluxe outer
MRC6985CG	Seat base	Deluxe centre
MTC3181CG	Seat back	Deluxe centre

Seat Frame		
349996	Front seat frame - Series 2 & 3 Black powder coated steel - 450 x 465mm	



## Defender &amp; Series - Rear Seats

Black Seats		
320737	Bench seat (810mm wide)	Rear assembly (inc. full fitting kit)
320647	Bench seat (810mm wide)	Rear back
396739	Bench seat (810mm wide)	Rear back - metal backed
320674	Bench seat (810mm wide)	Rear base
DA3059	Bench seat (1,200mm wide) - LWB	Rear assembly (inc. full fitting kit)
396698 NEW	Bench seat (1,200mm wide) - LWB	Rear back
320719 NEW	Bench seat (1,200mm wide) - LWB	Rear base
DA4067	Rear seat	Individual inward facing

County Grey Seats		
320737CG	Bench seat (810mm wide)	Rear assembly (inc. full fitting kit)
320647CG	Bench seat (810mm wide)	Rear back
320674CG	Bench seat (810mm wide)	Rear base

Grey Seats		
320737LCS	Bench seat (810mm wide)	Rear assembly (inc. full fitting kit)
320647LCS	Bench seat (810mm wide)	Rear back
320674LCS	Bench seat (810mm wide)	Rear base
DA3059LCS	Bench seat (1,200mm wide) - LWB	Rear assembly (inc. full fitting kit)
DA4075	Rear seat	Individual inward facing

Techno Style Seats		
320737T	Bench seat (810mm wide)	Rear assembly (inc. full fitting kit)
320647T	Bench seat (810mm wide)	Rear back
320674T	Bench seat (810mm wide)	Rear base
DA3059T	Bench seat (1,200mm wide) - LWB	Rear assembly (inc. full fitting kit)
DA4075T	Rear seat	Individual inward facing

Vinyl Twill Seats		
320737RPI	Bench seat (810mm wide)	Rear assembly (inc. full fitting kit)
320647RPI	Bench seat (810mm wide)	Rear back
320674RPI	Bench seat (810mm wide)	Rear base
DA3059RPI	Bench seat (1,200mm wide) - LWB	Rear assembly (inc. full fitting kit)
DA4075RPI	Rear seat	Individual inward facing

Seat Belt		
MXC5495	Lap belt - single	Suitable for 810mm and 1,200mm bench seats

Replacement Straps		
302648 NEW	Replacement strap for 320737, 320737CG, 320737LCS, 320737RPI	
IPM000010 NEW	Replacement strap for DA4067, DA4075, DA4075T, DA4075RPI	



Photos of these seats  
available online  
[www.britpart.com/seats](http://www.britpart.com/seats)



## Lightweight &amp; Military Seats

Black Seats		
MUC1488G NEW	Centre MOD spec	Back
MRC3657 NEW	Standard outer - pin fitment MOD spec	Back

Light Grey Seats		
RRC5513LOY	Radio operators seat	Seat assembly
RRC5514LOY NEW	Radio operators seat	Back
RRC5515LOY NEW	Radio operators seat	Base
RRC8572LOY	Wolf rear bench seat assembly	Seat assembly
RRC7896LOY NEW	Wolf rear bench seat cover	Back cover
RRC7897LOY NEW	Wolf rear bench seat cover	Base cover

Grey Seats		
RRC5513LCS NEW	Radio operators seat	Seat assembly
349172	Military lightweight	Base
346089	Military lightweight	Back
349988 NEW	Bench seat (810mm wide) MOD spec	Rear base
MWC5465LCS NEW	Bench seat (810mm wide) MOD spec	Rear back
MWC5599LCS NEW	Seat back - bolt fitment - adjustable MOD spec	Standard outer

Photos of these seats available online [www.britpart.com/seats](http://www.britpart.com/seats)



# SEATS & TRIM

## Carpet Kits

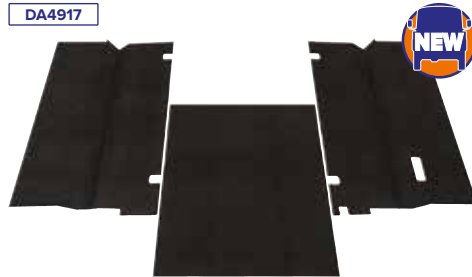
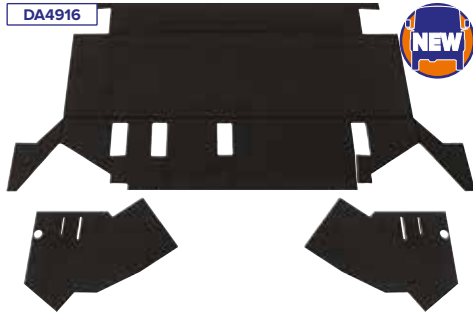
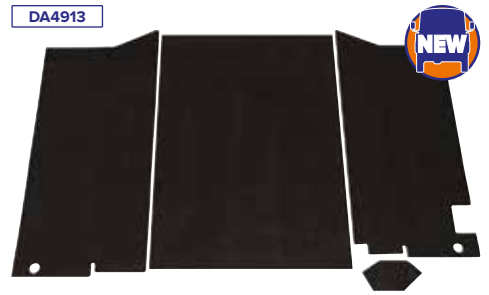
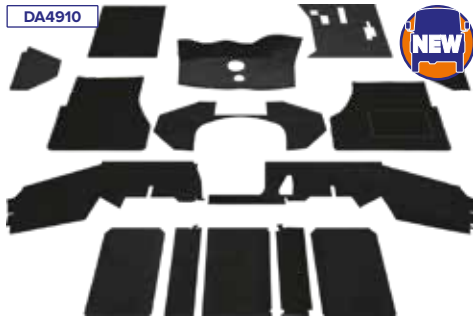

### Defender Carpet Kits

Once installed, these easy to fit, hard wearing carpet kits will transform your Defender's interior. The black 5mm woven pile carpet is manufactured with a hardback which ensures it holds its shape for years to come. All holes are pre-cut for a precision fit. No glue is required and with only strips of double-sided tape (supplied where applicable), fitment is quick and easy with no mess. The carpet also has the added advantage of improving soundproofing within the cabin. When applicable, floor mats have a reinforced edged for a smart, hard wearing finish.

**Note** - The carpet kit will not fit over rubber moulded mat sets. As a general rule, our carpet will however, fit over sound proofing kits such as Dynamat. Why not Dynamat your vehicle at the same time as fitting this kit. See our extensive range of kits - [www.britpart.com/dynamat](http://www.britpart.com/dynamat)



### DA4910 NEW

Defender - up to & including 200Tdi  
LT77 gearbox - Excludes V8  
Right hand drive

**Front Kit** - Bulkhead panel, gear box tunnel, floor mats, under dashboard panels, kick plate panels & seat box panels

### DA4911 NEW

Defender - 300Tdi & Td5  
R380 gearbox - Excludes V8  
Right hand drive

**Front Kit** - Bulkhead panel, gear box tunnel, floor mats, under dashboard panels, kick plate panels & seat box panels

### DA4912 COMING SOON

Defender - 2007 onwards - Right hand drive

**Front Kit** - Bulkhead panel, gear box tunnel, floor mats, under dashboard panels, kick plate panels & seat box panels

### DA4913 COMING SOON

Defender 90 - without rear seats - square arches

**Rear Kit** - Wheel arches, floor & filler cap cover

### DA4914 COMING SOON

Defender 90 - Station Wagon with inward-facing seats - square arches

**Rear Kit** - Wheel arches & floor

### DA4915 COMING SOON

Defender 90 - Station Wagon with forward-facing seats - cut-away arches

**Rear Kit** - Wheel arches & floor

### DA4916 NEW

Defender 110 & 130 - Commercial & **not** Station Wagon - cut-away arches

For vehicles with door retainers

**2nd Row Kit** - Floor carpet & forward-facing rear pieces

### DA4917 NEW

Defender 110 - without rear seats - cut-away arches

**Rear Kit** - Wheel arches & floor

### DA4918 COMING SOON

Defender 110 - Station Wagon with inward-facing seats - square arches

**Rear Kit** - Wheel arches & floor

### DA4919 COMING SOON

Defender 110 - Station Wagon with forward-facing seats - cut-away arches

**Rear Kit** - Wheel arches & floor

### DA4920 COMING SOON

Defender 110 & 130 - Station Wagon

For vehicles without door retainers

**2nd Row Kit** - Floor carpet & forward-facing rear pieces



Watch how easy the kits are to fit...  
[www.britpart.com/fitting](http://www.britpart.com/fitting)



*Holes are pre-cut for a precision fit*



Sparco Seats



DA7301



DA7305



DA7302



DA7303



DA7304

DA7301	Black leatherette	Single
DA7302	Black/blue	Single
DA7303	Black/grey	Single
DA7304	Black/black	Single
DA7305	Black/red	Single
DA7306	Seat runners	Single

- > Lightweight and compact
- > High comfort
- > Tubular frame construction
- > High quality recline mechanism for smooth and easy adjustment
- > Compatible with 3 or 4 fixing point harnesses
- > Base mounted - 271 x 345mm



These Sparco seats are ideal for Defenders (excluding truck cabs\*). Drawing on decades of racing history, Sparco has created a line of street car seats that offer the ultimate in comfort and performance. The ergonomic designs help cradle and protect the driver against even the most demanding lateral forces.

The R100 is Sparco's latest incarnation of ground-breaking steel-model seats. It features redesigned bolsters for greater support and new padding configurations for improved comfort. It has been built with comfort and support in mind but it's lower side bolsters and slightly narrower steel frame allow it to fit into vehicles where fitting seats with larger side bolsters may be difficult. The seat features backrest harness slots so that it can be used with a race type harness or normal seatbelts.

The seats can be reclined using the double adjuster lever. Made from a durable fabric, the R100 is available in single tone or duo-tone styles. Duo-tone styles feature contrasting side accenting and stitching to match any interior. The Sparco R100 range is designed to attach using Sparco vehicle specific seat mounts.

\*Not suitable for vehicles with truck cabs fitted as they restrict the leg room in the vehicle.



DA7307	Mounting kit - removable	Single
DA7308	Mounting kit - fixed	Single

Corbeau Seats

Corbeau Sportline RRS Low Base Seats

A revised version of the RSS, the Low Base has been designed specifically for Defender owners. The RRS has modern styling, giving you the ultimate in comfort and safety. This steel-framed sports recliner has a high quality moulded foam cushion, with lumbar support to give maximum comfort whilst not compromising lateral support. With its ultra low side bolster this is the perfect application for any high rise vehicle.

Fitted with a high quality single reclining and tilting mechanism for ease of adjustment.

Sold in pairs.

Dimensions

Base width	500mm
Length	560mm
Height	930mm
Shoulder width	540mm
Thigh width	350mm

DA7317	Leather & Alcantara	Pair
DA7311	Dakota leather	Pair
DA7310	Vinyl	Pair



Corbeau Harness Pads

Provide extra padding for all seat belt widths. The harness pads can be used for on road, off-road or competition.

- > Provides extra padding for all seat belt widths
- > Supplied as a pair
- > Suitable for 50mm harness straps
- > Velcro fastening

DA7314	Red
DA7315	Blue
DA7316	Black

Seat Mounting Kit

DA2778	Seat mounting plates	Pair
--------	----------------------	------



Ultimate in  
comfort &  
safety



DA7317



DA7311



DA7310



# SEATS & TRIM

## Seats

### Re-trim Kits



DA5628



DA5675



DA5634

#### Outer Seats

##### Defender - from VIN AA677964 to 2007

(non-plastic backed front squab)

An outer Britpart re-trim kit includes:

- 1 x Can of contact adhesive spray
- 1 x Squab foam
- 1 x Squab cover
- 6 x Plastic nails
- 3 x Cable ties
- 1 x Cushion foam
- 1 x Cushion cover
- 1 x Headrest cover
- 2 x Metal rods
- 1 x Rubber retainer

	Includes adhesive spray	Excludes adhesive spray
Vinyl twill	DA5627	DA5627E
Techno	DA5628	DA5628E
Black	DA5629	DA5629E
Grey	DA5630	DA5630E
Black mesh	DA5603	DA5603E

#### NAS Spec Seats

Vinyl twill main panel with black vinyl borders

DA5637 NEW DA5637E NEW

#### Second Row Seats

Defender 110 - 1983 - 2006 except 60/40 split seats

##### DA1438T

Techno  
A second row Britpart re-trim kit includes:  
1 x Cushion foam  
1 x Cushion cover  
1 x Squab foam  
1 x Squab cover



#### Headrests

##### Defender - up to 2007

A headrest Britpart re-trim kit includes:  
1 x Cushion foam  
1 x Headrest cover

DA5688

- DA5687 Vinyl twill
- DA5688 Techno
- DA5685 Black
- DA5686 Grey

### Off-roading? Got a working Land Rover?

Well the chances are your seats won't be in showroom condition, luckily Britpart have the answer - a Defender re-trim kit.



#### Online Fitting Guide

We have compiled a 25 minute tutorial giving you a detailed step-by-step on how to disassemble and assemble your Defender seat and information on the correct use of the included parts.

[www.britpart.com/re-trim](http://www.britpart.com/re-trim)

*Black Mesh material re-trim kits now available. Matching cubby box also available with Black Mesh top.*



*All products leaving the Trim Shop are manufactured to the highest standard.*

### Seat Handle & Cover Kit



DA5495

A pair of Defender seat handles and covers

### Trade Tack Stab

##### DA6348

Super bond spray adhesive

- > High strength
- > Variable spray
- > Quick
- > Clean
- > High tack/long tack
- > Very fast set
- > 250ml aerosol

Ideal for bonding and laminating of polyurethane foam, polystyrene foam, fibres, fabrics & felts etc to themselves.





**Defender & Series**

DA2662MESH



Fitting a Britpart cubby box in your Land Rover will help you keep your vehicle clutter free. With a double cup holder as standard, spilt drinks are a thing of the past. Hand-built in the UK, these quality cubby boxes are suitable for Series 3 and Defenders. Expertly crafted with precision tools using a hard wearing leatherette outer with locking stay brass hinges.

FWJ500020PMA



**'Chubby' Boxes**

Fitting a Britpart 'Chubby' box in your Land Rover will also make driving more of a pleasure with the extra padded lid. In addition to our standard cubby box features, our 'Chubby' boxes have a lovely thick and comfy 80mm thick lid. This compares to 20mm thick lid for a standard cubby box.

	Style	Top	Body
DA2035		Black	Black
DA2662	'Chubby'	Black	Black
DA2035LCS		Grey	Grey
DA2662LCS	'Chubby'	Grey	Grey
DA2035RPI		Vinyl twill	Grey
DA2662RPI	'Chubby'	Vinyl twill	Grey
DA2035T		Techno	Grey
DA2662T	'Chubby'	Techno	Grey
DA2035MESH		Black mesh	Black
DA2662MESH	'Chubby'	Black mesh	Black
DA2035GREY	XS Style	Light grey	Dark grey

**FWJ500020PMA**

Cubby box double cup holder for both old and new model Defenders - ideal for holding a Britpart travel mug or two!!  
**Note** - Will fit Defenders up to 2007. To fit to existing carpet lined cubby box the lining may have to be taken out. Excludes travel mug - DA8015.

**'Chubby' Boxes**

**Extra padded lid!**



DA2035



DA2035LCS

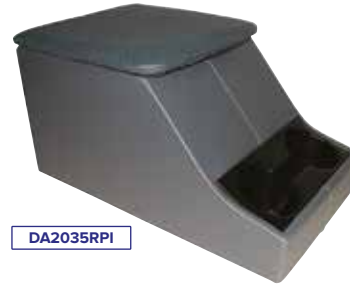

DA2035RPI

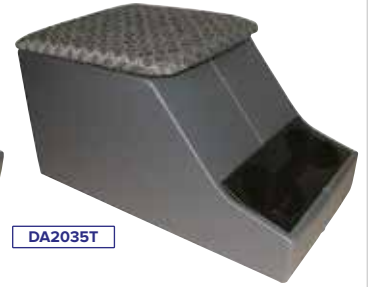

DA2035T



DA2035MESH



DA2035GREY



DA2149

**DA2149 Security Cubby Box**  
If security is a worry, then peace of mind can be achieved with this secure powder coated steel cubby box with padded lid. Includes a lockable slot for radios and CB units. 2 keys & 3 removable cup holders.



DA2662LCS



DA2662T



DA2662RPI

**Discovery Sport**



DA5142



DA5144



DA5143



DA5145

- DA5144 Black real leather
- DA5142 Black eco leather
- DA5143 Black automotive fabric
- DA5145 Almond real leather

Armrest with soft pad and real stitching for Discovery Sport models without one fitted originally. The armrest is made and designed using only quality materials to guarantee comfort and longevity. Handmade in Italy.

- > Innovative design
- > Soft pad
- > Fits right and left hand drive vehicles
- > Invisible fitting system - no screws or brackets in sight
- > Flips up and out of the way
- > Do-it-yourself fitting in only 5 min

**Handmade in Italy**



# SEATS & TRIM

## Cubby Boxes & Armrests

### Freelander



#### Freelander 1 - 2001 - 2006

Add some comfort to your Freelander with one of these stylish adjustable armrests.

- > Innovative design
- > Easy do-it-yourself installation

290 L x 170 W x 130mm H

<b>DA5116</b>	Black eco leather
<b>DA5117</b>	Black real leather
<b>DA5118</b>	Smokestone real leather

#### Freelander 2 - up to 2012

**Without factory fitted armrest**

Add some extra storage space in your Freelander 2 with one of these stylish cubby boxes.

- > Innovative design
- > Strong ABS storage base
- > Large storage capacity
- > Easy do-it-yourself installation in only 5 minutes in the original point
- > Boxes have adjustable sliding tops

<b>DA5101</b>	RHD	Black real leather
<b>DA5102</b>	RHD	Black eco leather
<b>DA5103</b>	RHD	Alpaca leather
<b>DA5113</b>	RHD	Almond leather
<b>DA5104</b>	LHD	Black real leather
<b>DA5105</b>	LHD	Black eco leather
<b>DA5106</b>	LHD	Alpaca leather
<b>DA5114</b>	LHD	Almond leather

#### Freelander 2 - up to 2012

**With factory fitted armrest**

Add some extra storage space in your Freelander 2 with one of these stylish cubby boxes.

- > Innovative design
- > Strong ABS storage base
- > Large storage capacity
- > Easy do-it-yourself installation in only 5 minutes in the original point

220 L x 125 W x 160mm H

<b>DA5115</b>	RHD & LHD	Black real leather
<b>DA5109</b>	RHD & LHD	Black eco leather
<b>DA5111</b>	RHD & LHD	Alpaca leather
<b>DA5112</b>	RHD & LHD	Almond leather

#### Freelander 2 - 2013 onwards

**Without original armrest in the seat**

> Armrest with soft pad and real stitching

- > Simple do-it-yourself fitting in only 5 minutes

280 L x 200 W x 220mm H

<b>DA5138</b>	RHD & LHD	Black eco leather
<b>DA5139</b>	RHD & LHD	Black automotive fabric
<b>DA5140</b>	RHD & LHD	Black real leather
<b>DA5141</b>	RHD & LHD	Almond real leather



For more images - [www.britpart.com/cubby](http://www.britpart.com/cubby)



Photo by Adam Breakspear

### Range Rover Evoque



**With non-adjustable armrests**

<b>DA5122</b>	Black
<b>DA5123</b>	Lunar
<b>DA5124</b>	Almond

**With adjustable armrests**

<b>DA5146</b>	Black
<b>DA5147</b>	Lunar
<b>DA5148</b>	Almond

Improve your driving position in a Range Rover Evoque with an additional armrest.

- > Manufactured from real leather and simple to fit.
- > The armrest can easily be moved to suit your driving position and you will still be able to access the cubby box.



## Door Trim - Side Doors

## Defender Side Door Cards

Replace the tatty old side door cards in your Defender with one of these smart plastic replacements. Easy to fit, they are also easy to keep clean with a wipe clean finish. Includes fasteners.

<b>DA2440</b>	Defender - up to 2007	Front casing	Manual window	Black	RHS
<b>DA2441</b>	Defender - up to 2007	Front casing	Manual window	Black	LHS
<b>DA2442</b>	Defender - up to 2007	Front casing	Manual window	Grey	RHS
<b>DA2443</b>	Defender - up to 2007	Front casing	Manual window	Grey	LHS
<b>DA2490</b>	Defender - up to 2007	Front casing	Manual window	Light Grey	RHS
<b>DA2491</b>	Defender - up to 2007	Front casing	Manual window	Light Grey	LHS
<b>DA2444</b>	Defender - up to 2007	Front casing	Electric window	Black	RHS
<b>DA2445</b>	Defender - up to 2007	Front casing	Electric window	Black	LHS
<b>DA2446</b>	Defender - up to 2007	Front casing	Electric window	Grey	RHS
<b>DA2447</b>	Defender - up to 2007	Front casing	Electric window	Grey	LHS
<b>DA2494</b>	Defender - up to 2007	Front casing	Electric window	Light Grey	RHS
<b>DA2495</b>	Defender - up to 2007	Front casing	Electric window	Light Grey	LHS
<b>DA3266</b>	Defender - 2007 - 2016	Front casing	Electric window	Black	RHS
<b>DA3267</b>	Defender - 2007 - 2016	Front casing	Electric window	Black	LHS
<b>DA2480</b>	Defender - up to 2007	Rear casing	Manual window	Black	RHS
<b>DA2481</b>	Defender - up to 2007	Rear casing	Manual window	Black	LHS
<b>DA2482</b>	Defender - up to 2007	Rear casing	Manual window	Grey	RHS
<b>DA2483</b>	Defender - up to 2007	Rear casing	Manual window	Grey	LHS
<b>DA2492</b>	Defender - up to 2007	Rear casing	Manual window	Light Grey	RHS
<b>DA2493</b>	Defender - up to 2007	Rear casing	Manual window	Light Grey	LHS
<b>DA2484</b>	Defender - up to 2007	Rear casing	Electric window	Black	RHS
<b>DA2485</b>	Defender - up to 2007	Rear casing	Electric window	Black	LHS
<b>DA2486</b>	Defender - up to 2007	Rear casing	Electric window	Grey	RHS
<b>DA2487</b>	Defender - up to 2007	Rear casing	Electric window	Grey	LHS
<b>DA2496</b>	Defender - up to 2007	Rear casing	Electric window	Light Grey	RHS
<b>DA2497</b>	Defender - up to 2007	Rear casing	Electric window	Light Grey	LHS

DA2440



For more images visit  
[www.britpart.com/door-trim](http://www.britpart.com/door-trim)



DA2490



DA2486



DA2029



DA2446



DA2480



DA2492



DA2030



## Series Side Door Cards

**DA2029** Series 3

Door trim lower Black RHS

**DA2030** Series 3

Door trim lower Black LHS

Note - Fixings not included.

## Military Defender Door Cards

**DA1642** Left hand side

**DA1648** Right hand side

DA1642

## Door Trim - Rear Doors

Defender 1987 - 2006 with wash wipe doors - Fixings not included

<b>MXC1992LCS</b>	Defender - FA358393 up to JA910753	Slate Grey
<b>BTR3793LCS</b>	Defender - JA910754 up to KA929577	Slate Grey
<b>BTR7959LCS</b>	Defender - KA929578 up to MA965105	Slate Grey
<b>BTR7964LCS</b>	Defender - KA929578 up to MA965105	Slate Grey
	For vehicles without wash wipe	
<b>BTR9712LCS</b>	Defender - MA965106 up to TA99921	Slate Grey
<b>BTR9712LOY</b>	Defender - MA965106 up to TA99921	Dark Granite
<b>BTR9712PMA</b>	Defender - MA965106 up to TA99921	Black



BTR7959LCS



DA2516

Defender - up to 2002 with rear wiper motor cover - Includes fixings

<b>DA2515</b>	Defender - up to 2002	Black
<b>DA2516</b>	Defender - up to 2002	Dark Grey
<b>DA2517</b>	Defender - up to 2002	Light Grey

Defender - 2007 - 2016

**LR033981 NEW** Rear door trim with pocket storage

Safari Doors - Fixings not included

**DA2124** Defender/Series 2 hinges Black

**MWC1743** Defender 3 hinges Black

For more images visit [www.britpart.com/door-trim](http://www.britpart.com/door-trim)

LR033981



DA2124



## Door Card Fixing Kits

DA4649



Defender door fitting kits. Ideal to keep handy if removing the door cards at any time. Front or rear single door.

**DA1411** Grey kit 2 x Lokut-nuts & 12 x fasteners

**DA1412** Black kit 2 x Lokut-nuts & 12 x fasteners

**DA4649** Black kit 2 x Lokut-nuts, 2 x clips, 12 x fasteners & 12 x snapsacs

## Dash Trim Kits

DA2098



Put a stop to the dreaded Discovery 1 dash peel with one of these repair kits.

**DA2090** Black

**DA2091** Blue

**DA2096** Grey

**DA2098** Brown

DA2091

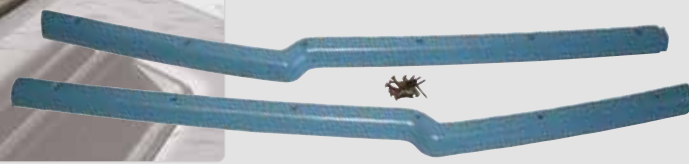



# SEATS & TRIM

## Trim

### Seat Box Protectors



- DA7370 NEW** Brushed Stainless Steel
- DA7371 NEW** Black steel

Defender Pair

The edge of the Defender seat box is prone to damage, protect that edge and smarten up your interior with these protectors. Made from 2mm steel. Less than 5 minutes to fit and all you need is a drill for the fixings. Kit includes a pair of corner protectors and 8 x 19mm flanged steel self drill fixings. These will also fit a Series 2 & 3 but will require matching drilling to accommodate seat rail fixing.

### Rear Window Surrounds



- DA2932**
- Defender 90**  
*With window cut-out*
- DA1643** Black
  - DA2933** Dark Grey
  - DA2932** Light Grey

- Without window cut-out*
- DA1644** Black
  - DA2935** Dark Grey
  - DA2934** Light Grey

These rear window surrounds will fit all versions of the 90, however, if the vehicle has a higher bulk head, the fitter will need to remove a section of the surround which is clearly marked with a witness line on the inside of the moulding. This can be done very easily with a 'Stanley' knife or similar.



### Interior Trim Panels



- Footwell Trim - Suffix A - Flat**
- 391294** Left hand drive Right hand side
  - 391295** Left hand drive Left hand side
  - DA1616** Pair - 391294 & 391295

- Footwell Trim - Suffix A - Flat**
- 391296** Right hand drive Right hand side
  - 391293** Right hand drive Left hand side
  - DA1613** Pair - 391293 & 391296

- Footwell Trim - Suffix B - Recessed Choke Below Dash**
- 392822** Right hand side
  - 392821** Left hand drive Left hand side
  - DA1601** Pair - 392821 & 392822

- Footwell Trim - Suffix B - Recessed Choke Below Dash**
- 392820** Right hand drive Right hand side
  - 392823** Left hand side
  - DA1602** Pair - 392820 & 392823



- Footwell Trim - Recessed with Cut-out**
- 392822AE** Right hand side
  - 392823AE** Left hand side
  - DA1630** Pair - 392822AE & 392823AE



- C-Pillar Trim - Suffix A**
- 391747** Right hand side
  - 391748** Left hand side
  - DA1604** Pair - 391747 & 391748



- C-Pillar Trim - Suffix B**
- 393046** Right hand side
  - 393047** Left hand side
  - DA1605** Pair - 393046 & 393047



- C-Pillar Trim - Suffix C onwards**
- 393434** Right hand side
  - 393435** Left hand side
  - DA1606** Pair - 393434 & 393435



- Seatbase Trim - 2-Door & Early 4-Door**
- 391524** Right hand side
  - 391525** Left hand side
  - DA1607** Pair - 391524 & 391525

*Restore your Range Rover Classic's interior to a top level finish by fitting new Palomino Beige interior trim panels.*

*An exact match to the originals. Available from Britpart as individual panels or pairs.*

*Like the original panels, they are manufactured from thermo moulded polystyrene.*

### Door Lock Button Kit



- DA2499**  
 Defender  
 3 piece - black



Canvas Hoods



*Got a Land Rover with a hood that has seen better days?*

**MUC4122ABE**

Tears? Frayed fixings? Scratched windows? Well give your vehicle a quick facelift with a new canvas hood from Britpart.

- > Hoods are made from the original 18oz canvas and made to OEM specifications
- > All fittings are brass and made to OEM specifications
- > Webbing is made the same way as the original
- > Polypropylene rope is the same construction as the original rope
- > Ropes are all inserted into the hood to help customers
- > Care instruction are included

Other hoods available on request - please ask for details.

<b>331110AG</b>	Series - SWB	Full hood	Khaki	Without windows	<b>331259AG</b>	Series - LWB	Full hood	Khaki	Without windows
<b>331113AG</b>	Series - SWB	Full hood	Khaki	With windows	<b>331260AG</b>	Series - LWB	Full hood	Khaki	With windows
<b>331110SA</b>	Series - SWB	Full hood	Sand	Without windows	<b>331259SA</b>	Series - LWB	Full hood	Sand	Without windows
<b>331113SA</b>	Series - SWB	Full hood	Sand	With windows	<b>331260SA</b>	Series - LWB	Full hood	Sand	With windows
<b>331110BL</b>	Series - SWB	Full hood	Black	Without windows	<b>MUC4122ABE</b>	Defender 90	Full hood	Sand	With windows
<b>331371AG</b>	Series - SWB	Three quarter hood	Khaki	Without windows					



Fume Curtain



**MRC3519**  
Defender/Series

Hood Stick Kits



<b>330999</b>	Hood stick kit	SWB
<b>332951</b>	Hood stick kit	LWB
<b>330553</b>	Replacement hood stick	SWB & LWB

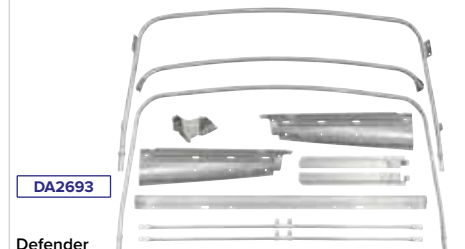

<b>DA2693</b>	Defender Hood stick kit for full canvas tilt. Includes fixings.
<b>DA2693</b>	Defender 90 - early vehicles For vehicles with the round header rail
<b>DA2986</b>	Defender 90 - Td5 onwards For vehicles with the flat header rail

Photo by Ming Lee



# SEATS & TRIM

## Seat & Trim Accessories

### Retrofit Seat Heaters

#### DA5717

These retrofit seat heaters will allow you to enjoy a comfortable and warm seat in any Land Rover vehicle with a removable seat cover. These highly durable and flexible heating elements are placed between the upholstery and seat cover on the seat base and back and will not alter the shape of the seats. There are two switches provided for the driver and passenger seats which allow the heat output to be altered to the two different settings. A ready-made cable set connects the switches to the 12V on-board power supply to the heat the pads. There are integrated temperature sensors which ensure that the seat heater will not overheat.

Operating voltage: 12 volt

Output: Low - 44 watts / High - 90 watts

Dimensions: Seat base - 400 x 280mm / Backrest - 300 x 280mm

- > Complete set for driver and passenger seats
- > Two stages of heating
- > Kit includes four heating elements and items needed for installation
- > Pre-assembled cable set with switching relay and buttons included
- > Temperature guard to prevent overheating
- > Heating elements are durable and extremely flexible
- > For use on seats which have a removable cover
- > Includes fitting materials and instructions
- > Test mark: e-approved to 95/54/EC (EMC guidelines for vehicles)

#### DA5717W

Domestic version available

[www.britpart.com/DA5717W](http://www.britpart.com/DA5717W) for full details



*Enjoy warm seats at the flick of a switch*



### Bulkhead Bars



#### DA1810

Defender OEM bulkhead removal bar kit

#### DA2351

Defender bulkhead reduction bar kit

#### Need more leg room and seat adjustment in your Defender?

These bulk head bars alleviate that problem without compromising strength. The bulk head bars allow for extra seat recline and travel on the seat base - giving you a more comfortable seating position and more space in the front foot wells. The bars create a rigid bracing for the front of the Defender tub as well as the added benefits of extra room in the vehicle due to the seats being more manoeuvrable, access to the rear of the Defender is now not compromised by a higher bulk head. Powder coated and supplied complete with all the necessary fixings and instructions.

### Extended Seat Rails



#### DA2148

Give your Defender (including 2007 onwards model) seats 3" of extra slide with a pair of these seat rails. Ideal for the taller driver to give a more practical and comfortable driving position. One pair of rails is suitable for one seat.

*Ideal for the taller driver.*

*A more practical and comfortable driving position.*

### Seat Belts



#### DA5055



#### DA5079

#### DA5056



#### DA5058

<b>DA5055</b>	Defender - truck cab	RHS	
	Equivalent to BTR6562		
<b>DA5056</b>	Defender - truck cab	LHS	
	Equivalent to BTR6561		
<b>DA5057</b>	Defender - station wagon		Front
	Equivalent to BTR6563		
<b>DA5079</b>	Defender - station wagon - Td5 onwards	RHS	Front
<b>DA5080</b>	Defender - station wagon - Td5 onwards	LHS	Front
<b>DA5058</b>	Defender - station wagon		Rear
	Equivalent to EVL501580		
<b>DA5059RH</b>	Defender 110 - 2007 onwards - crew cab pick up - non-hi-cap		Rear outer - right hand side
	Equivalent to EVL501600PMAG		
<b>DA5059LH</b>	Defender 110 - 2007 onwards - crew cab pick up - non-hi-cap		Rear outer - left hand side
	Equivalent to EVL501610PMAG		
<b>DA5060RH</b>	Defender 110 - From YA183533 - 2007 - crew cab pick up - non-hi-cap		Rear outer - right hand side
	Equivalent to EVL000080PMAG		
<b>DA5060LH</b>	Defender 110 - From YA183533 - 2007 - crew cab pick up - non-hi-cap		Rear outer - left hand side
	Equivalent to EVL000090PMAG		

Add a splash of **colour** to your Defender's interior by fitting a set of these red seat belts. Type approved.

### Seat Belt Stress Plate



#### DA3502

FIA specification stress plate with 65mm square backing plate and 7/8" captive nut.



**Gear Box Gaiters**



DA5499



DA5497



FJL101530PMA / FJL101680PMA / FJL101710PMA



300914

DA5498

301147



<b>Defender</b>			
DA5498	Defender	Grey	
DA5499	Defender	Black	
DA5497	Defender - 2007 onwards	Black	
<b>Series</b>			
DA2466	Series	Black	
Kit - Handbrake, gearstick and 4-wheel drive selector			
300914	NEW Series 1 - 80"	Handbrake lever seal	Black
301147	NEW Series 1 - 80"	Transfer lever seal	Black



DA2466

<b>Discovery 1 &amp; Discovery 2</b>			
FJL101680PMA	Gear lever	Black	
FJL101710PMA	Handbrake lever	Black	
FJL101530PMA	High/low lever	Black	

**Note** - Individual gaiters supplied with gaiter housing.



DA5496

DA5496	Re-trim kit	Black
--------	-------------	-------

Vinyl gaiters are glued into place on the original gaiter housing. Contents - Gaiters for gear lever (FJL101680PMA), handbrake lever (FJL101710PMA) & high/low lever (FJL101530PMA).

**Glove Boxes**



DA2603



DA2603CF

Neat storage solution for the Defender - 2007 onwards model - which utilises the available dashboard space.

Ideal for storing all the usual small items you carry with you. Robust construction and easy to fit with all the necessary parts supplied.

Suitable for both right and left hand drive vehicles.

DA2603	Normal interior finish fascia plate
DA2603CF	Carbon fibre effect finish fascia plate



DA2603CF

**Door Stays**

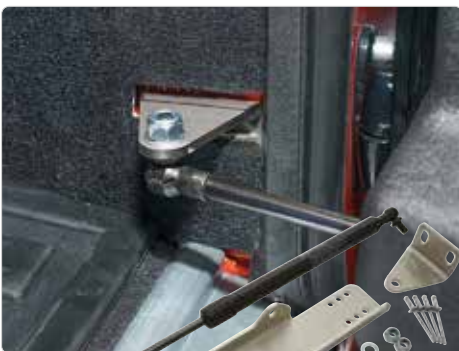

DA1203

**Does your Defender's rear door sometimes close on you unexpectedly?**

This neat and easily installed gas strut kit will solve that problem and replaces the original door stopper. The gas strut will hold the door in place when open - even with a spare wheel in place - and will assist in the opening of the rear door too with a smoother and more controlled movement. Complete with fittings and instructions.

DA1204	Defender - up to 2002
DA1203	Defender - 2002 onwards

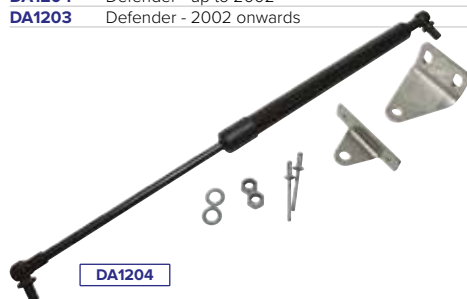

DA1204

**Chain Cover**



330422

<b>Series</b>	
Defender - 1987 - 2006	
Stop your tailgate chain rattling away with this easy to fit chain cover. Pack of 2. Requires 2 per side.	
330422	Black
330422GREY	Grey

330422GREY





Photo by Emre Kuzu



# OFF-ROAD

Take Your  
Adventures Further



# OFF-ROAD

## Air Compressors

### Britpart Air Compressors

#### Features for both air compressors

- > 12 volt
- > Max. pressure - 150psi
- > 10m air hose with heavy-duty gauge & brass fittings
- > Integrated sand tray
- > Blow moulded case
- > Anti-vibration rubber feet

#### DA2392XS

#### Double Pump Compressor

- > 50 amp
- > Air flow - 150ltr/min
- > Automatic cut-off to prevent overheating
- > 2m wires with heavy-duty clamps

#### DA2394XS

#### Single Pump Compressor

- > 40 amp
- > Air flow - 72ltr/min
- > 3m wires with heavy-duty clamps

#### DA2394XS

Replacement air filter for DA2354XS & DA2392XS

#### DA2354FUSE40A

Replacement fuse for DA2354XS

#### DA2392FUSE50A

Replacement fuse for DA2392XS



DA2392XS

DA2354XS



Screw in air filter - DA2394XS

Heavy-duty gauge

Heavy-duty battery clips

3 nozzles

In-line fuse

Built-in sand tray

10m coiled hose

Anti-vibration rubber feet



Blow moulded case

**Ideal for 4x4 use!**

### Ring Air Compressor



#### DA5078

#### Ring Rapid Digital Tyre Inflator

- > Powerful inflation from a 12V socket
- 4x4 tyre inflates in 5 minutes.
- > Easy and accurate set up - rotating dial to pre-set the pressure. Automatically stops once pressure reached. Screen on top of the device to read easily while using.
- > LED light built in for safer use at night.
- > Back lit digital display is easy to read.
- > Long cables to reach tyres all around the vehicle.
- > Comes with three piece adaptor kit for small inflatables & bikes.

## Diff Lockers & Associated Equipment

### ARB Diff Lockers, Air Compressors & Equipment

#### LX100

#### LINX - The Next Generation Of 4x4 Accessories

LINX is a unique modern controller that de-clutters the dashboard and centralises the command of vehicle accessories by replacing classic switches, gauges and monitors with one sleek and smart driver interface. Built on an expandable platform, LINX will continue to evolve your on and off-road driving experience both now and into the future.

#### Experience Total Control

Fitting out a modern 4x4 with a range of accessories such as driving lights, air lockers, dual batteries and air compressors can quickly lead to a dash full of out of place, hard to reach switches and a myriad of gauges and monitors either stuck to the windscreen or drilled into the dashboard - not to mention all the associated fuses and wiring.

LINX offers a single point of control via its user-friendly, Bluetooth enabled, mobile touch screen display. The LINX mobile display mounts conveniently and unobtrusively within reach of the driver while the main control hub lies neatly out of sight under the dash or seat; taking care of all accessory wiring.

LINX comes with six pre-installed modules: Front and Rear Traction, Compressor Control, Accessory Switchboard, Battery Monitor, Speedometer and Air Suspension Control.

#### General Settings

Beyond its expansive range of modules, LINX presents a truly adaptable platform with module level settings, as well as, many additional general settings.

#### Functions

- > Set theme colour to match your vehicle's dash
- > Engage night mode which engages when your headlights are activated
- > Set all measurements to your preferred units
- > Software upgradeable via WiFi connection

#### 7450109

#### LINX Airbag Suspension Isolation Kit

This allows owners with air suspension to take full advantage of LINX's Airbag Suspension Module

#### 7450107

#### LINX Pressure Control Kit

Offering 'set & forget' simplicity to tyre inflation as well as remote control over your airbag suspension



#### What's In The Box

- > LINX display screen
- > LINX controller
- > USB charge cable
- > 3 wiring looms
- > LINX gimbal mount
- > Quick start-up guide
- > 1 Pre-installed display screen protector

There's much more to LINX than meets the eye - see how it can unlock a brand new experience with your 4x4 accessories. Visit the LINX site to explore each feature - [linx.arb.com.au](http://linx.arb.com.au)



## 4X4 ACCESSORIES

ARB products available in the UK only.



#### ARB High Flow On-board Compressor Assembly

- > Airflow - 87.2lpm
- > Designed for Air Locker use
- > Sealed for moisture and dust resistance
- > Quality components for quiet operation and extra long life
- > Hard anodised cylinder bore & Teflon impregnated carbon fibre piston seal for reduced friction & maximum trouble free life
- > Heavy-duty maxi-fuse equipped for professional in-line circuit protection
- > Anodised mounting brackets dissipates motor heat and allows compressor to be repositioned by 180°
- > Constructed entirely of lightweight, high strength engineering grade materials
- > Over-pressure safety valve equipped
- > Motor is internally thermal protected against extreme temperature damage

DA4190  
12 volt  
DA419024V  
24 volt

#### DA4958

#### ARB Compact 12 Volt On-board Compressor Assembly

- > Airflow - 27.7lpm
- > Designed for Air Locker use
- > Compact, vehicle mounted design
- > Sealed for moisture & dust resistance
- > Quality components for quiet operation & extra long life
- > Mounting bracket allows for versatile positioning
- > Kit contains 12V air compressor, mounting bracket & hardware, auto on/off pressure switch, plug-in Air Locker wiring loom and installation instructions



#### DA4985

#### ARB Twin On-board Compressor Kit

Designed to fill the market need for a compact sized yet high-volume compressed air source to suit the high volume airflow needs of most air powered tools it also suits the actuation and control needs of the ARB Air Locker, and the harsh and demanding environment of the ARB Air Locker user. Much more information available online.



ARB Diff Lockers, Air Compressors & Equipment



DA8961

- 180223SP NEW** Front locker dash switch
- 180224SP NEW** Rear locker dash switch
- 180222SP NEW** Compressor dash switch
- DA8959** Switch bracket - 1 switch
- DA8960** Switch bracket - 2 switches
- DA8961** Switch bracket - 3 switches

**DA6836**  
ARB Air Tank

- 
- Ideal for use with ARB's twin motor and high output on-board compressors.
  - > 4 litre aluminium air tank
  - > Rated to a maximum working pressure of 1030KPA (150PSI)
  - > Delivers high volume air output suitable for rapid tyre inflation and most air powered tools
  - > Two ¼ NPT ports (input and output) with JIC-4 male fitting pre-installed
  - > Designed for use with ARB's on-board compressors
  - > 50% lighter than an equivalent steel tank
  - > Mounting hardware included

**DA6837**  
ARB Air Locker Manifold Kit

- 
- > Designed for the remote mounting of air locker solenoids
  - > Stainless steel braided PTFE hose and fittings connect to and cool the compressor outlet air
- Kit includes  
 Manifold body with mounting bracket  
 2 x ½" BSP ports for installation of up to 2 x Air Locker solenoids  
 2 x ¼" NPT ports, one to be used as an input and the second could be used for installation of a pump up kit  
 1 x high temperature resistant Teflon stainless steel braided hose with heavy duty JIC4 fittings  
 2 x JIC4 - ¼" NPT nipples to connect the included hose to the compressor outlet and manifold kit input  
 2 x M6 hex head bolt and nylon lock-nuts for securing the manifold kit

**0740300**  
ARB Air Locker Heavy-duty Pressure Air Line Kit

The kit is designed for use on one locker. Suits black 6mm and existing blue 5mm. No hose.



**DA8994**  
ARB Air Compressor Pressure Switch

Threads into the ARB air compressor to regulate internal pressure in the compressor tank. Turns compressor on at 70psi and off at 100psi.

**180409**  
ARB Wiring Loom

ARB air compressor wiring loom for DA4190 & DA419024V



**170112**  
ARB Diff Breather Kit

- > Specifically engineered to work with differentials and ARB Air Lockers
  - > Compact and lightweight design with push-in fittings for simple installation
  - > Four breather ports for multiple applications
  - > Mounting holes will accommodate M6 bolt or stud
  - > Splash resistant air filter with washable high flow sintered bronze filter cartridge
  - > Oil, water and heat resistant 8mm polyurethane tubing reduces likelihood of oil blockages
- 1 x Anodised aluminium manifold  
 1 x Air filter  
 1 x 8mm x 8m polyurethane tubing  
 4 x 8mm- 1/8" BSP push-in fittings  
 3 x 1/8" BSP plugs  
 2 x Self-tapping screws  
 10 x Cable ties

**DA8988**  
ARB Diff Air Feed Ring & Pipe



**DA4392**  
Replacement Solenoid

For the compressors to activate the ARB airlockers.



**3501010**  
ARB Universal Compressor Bracket

Enables the installation of compressors DA4190, DA419024V, DA4958 & DA4985 and air tank DA6836 with optional Air Locker solenoids, quick connect coupling, switch, manifold kit (DA4985 only) and ARB LINX PRV in various mounting positions.



**DA8987**  
ARB Diff Side Clip

ARB - RD150602



**160235-2 NEW**  
ARB O-Rings

2 x O-Rings for 24 spline air locker



**DA8956**  
ARB Bulkhead Fitting Kit

Handy little kit to help pass an airline through any panel. 5mm to 3.5mm O-ring type. ARB 170111



**171314 NEW**  
ARB Remote Hose Coupling Mount Kit

Mount the output for the air compressor remotely in the vehicle.





Those who enjoy heading off the beaten track in their 4x4 know that even the most familiar tracks can present you with unexpected conditions. Whether you're up against a steep incline, uneven & rocky terrain or a slippery muddy track, being able to take advantage of traction is one of the most important elements.

In a vehicle with open differentials in 4WD mode, drive can only go to two wheels at any given time. At the flick of a switch, an ARB Air Locker can send equal drive to both wheels on an axle allowing you to take advantage of the wheels that have traction and push forward along the track.



#### ARB Diff Lockers

- > Provides 100% traction on demand without affecting on road driveability or driveline wear
- > Vastly improved traction means less reliance on momentum, thus reducing the likelihood of vehicle damage and environmental impact
- > Easy, convenient operation allows the driver to concentrate on the terrain without leaving the comfort and safety of their seat
- > Ultra durable and extremely strong - only the highest quality materials used in construction
- > Incredibly simple yet effective design that employs minimal moving parts, thereby ensuring maximum reliability
- > Thoroughly tested and proven design - trusted and used in over 80 countries around the world
- > Easy installation and maintenance - no special tools, skills or additives required
- > Two year warranty guarantees the Air Locker will be free of defects in materials

Air Locker locking differentials allow you to tackle the toughest terrain. As the world's premier traction aid, ARB Air Lockers keep you moving in all conditions. Ultra durable and extremely strong - only the highest quality materials used in construction.



## 4X4 ACCESSORIES

ARB products available in the UK only.

**Notes -** 1. If vehicle was manufactured during 1993, check spline count. 2. Air Locker not available for vehicles equipped with high load option. 3. Ring gear spacer required. Longer ring gear bolts (not supplied) are also necessary - (Land Rover part no. 576521). 4. When an DA4191 Air Locker is to be installed in Range Rovers manufactured prior to 1980 (approx.), special carrier bearings (No. K11300/K11162) may also be necessary - Land Rover part no. RTC3426. 5. Some vehicles have crown wheel bolts which cannot be reused and must be replaced. Consult service manual. 6. P38A is most commonly found in traction control equipped vehicles. Identify P38A type diff by large 205mm [8.07"] flange diameter. P38A was not used on North American delivered Discoverys - use DA4193.

Part Number Series	Vehicle/Model	Year	Axle Location	Shaft Description	Shaft Diameter	Spline	Ratio
DA4191 <sup>2,3</sup>	Series 1/Series 2/Series 3	1948 - 1985	Front	Rover type	28.2 (1.11")	10	4.7
DA4191 <sup>2,3</sup>	Series 1/Series 2/Series 3	1948 - 1985	Rear	Rover type	28.2 (1.11")	10	4.7
<b>Defender</b>							
DA4191 <sup>1</sup>	Defender 90	1984 - 1993	Front	Rover type	28.2 (1.11")	10	3.54
DA4193 <sup>1,5</sup>	Defender 90	1993 onwards	Front	Rover type	31.5 (1.24")	24	3.54
DA4193 <sup>1,6</sup>	Defender 90	2007 onwards	Front	Rover type	31.5 (1.24")	24	3.54
DA4191 <sup>1,2</sup>	Defender 90	1983 - 1993	Rear	Rover type, 4 cyl. petrol & diesel engines	28.2 (1.11")	10	3.54
DA4193 <sup>1,6</sup>	Defender 90	1993 onwards	Rear	Rover type	31.5 (1.24")	24	3.54
DA4344 <sup>6</sup>	Defender 90	2002 onwards	Rear	Rover type, P38A	31.5 (1.24")	24	3.54
DA4193 <sup>1,6</sup>	Defender 90 with 2 pin rear diff	2007 onwards	Rear	Rover type	31.5 (1.24")	24	3.54
DA4344 <sup>6</sup>	Defender 90 with 4 pin rear diff	2007 onwards	Rear	Rover type, P38A	31.5 (1.24")	24	3.54
DA4191 <sup>1</sup>	Defender 110/130	1983 - 1993	Front	Rover type	28.2 (1.11")	10	3.54
DA4193 <sup>1,5</sup>	Defender 110/130	1993 onwards	Front	Rover type	31.5 (1.24")	24	3.54
DA4193 <sup>1,6</sup>	Defender 110/130	2007 onwards	Front	Rover type	31.5 (1.24")	24	3.54
DA4192	Defender 110/130	1983 - 2002	Rear	Salisbury type	31.5 (1.24")	24	3.54
DA4193 <sup>6</sup>	Defender 110/130	2002 onwards	Rear	Rover type	31.5 (1.24")	24	3.54
DA4344 <sup>6</sup>	Defender 110/130	2002 onwards	Rear	Rover type, P38A	31.5 (1.24")	24	3.54
DA4344 <sup>6</sup>	Defender 110/130	2007 onwards	Rear	Rover type, P38A	31.5 (1.24")	24	3.54
<b>Discovery</b>							
DA4191 <sup>1</sup>	Discovery 1	Up to 1993	Front	Rover type	28.2 (1.11")	10	3.54
DA4193 <sup>1,5</sup>	Discovery 1	1993 - 1998	Front	Rover type	31.5 (1.24")	24	3.54
DA4191 <sup>1</sup>	Discovery 1	Up to 1993	Rear	Rover type	28.2 (1.11")	10	3.54
DA4193 <sup>1,5</sup>	Discovery 1	1993 - 1998	Rear	Rover type	31.5 (1.24")	24	3.54
DA4193 <sup>1,5</sup>	Discovery 2	All	Front	Rover type	31.5 (1.24")	24	3.54
DA4193 <sup>6</sup>	Discovery 2	All	Rear	Rover type	31.5 (1.24")	24	3.54
DA4344 <sup>6</sup>	Discovery 2	2002 onwards	Rear	Rover type, P38A	31.5 (1.24")	24	3.54
DA6254	Discovery 3	All	Front	IRS, Clamshell type	31.5 (1.24")	29	All
<b>Note - Check diff ratio before ordering this part.</b>							
DA6252	Discovery 3	All	Rear	IRS, Clamshell type	33.6 (1.32")	31	All
<b>Range Rover</b>							
DA4191 <sup>1,4</sup>	Range Rover Classic	Up to 1992	Front	Rover type	28.2 (1.11")	10	3.54
DA4193 <sup>1,5</sup>	Range Rover Classic	1993 - 1996	Front	Rover type	31.5 (1.24")	24	3.54
DA4191 <sup>1,4</sup>	Range Rover Classic	Up to 1992	Rear	Rover type	28.2 (1.11")	10	3.54
DA4193 <sup>1,5</sup>	Range Rover Classic	1993 - 1996	Rear	Rover type	31.5 (1.24")	24	3.54
DA4344 <sup>5</sup>	Range Rover P38	1996 - 2002	Front	Rover type, P38A	31.5 (1.24")	24	3.54
DA4344 <sup>5</sup>	Range Rover P38	1996 - 2002	Rear	Rover type, P38A	31.5 (1.24")	24	3.54
DA6254	Range Rover Sport	2005 - 2013	Front	IRS, Clamshell type	31.5 (1.24")	29	All



#### ARB Diff Cover

Defender - rear Salisbury axles.  
High tensile solid nodular iron structure (tougher and harder than solid carbon steel) protects the differential and ring & pinion set from the obstacle impact hazards of competition rock crawling, or extreme off road trails.  
More information available online.

- DA8926 Red
- DA8934 Black



Ashcroft Transmissions



DA1224

**DA1225 Cross Pin**  
The standard LT230 transfer boxes have a two piece cross pin in the centre diff, this is two shafts with a cut out in the centre so they can overlap. This one piece heavy-duty cross pin is much stronger.

**Diff Locker**

- > A unique non-rotating annular piston locking actuator is designed to eliminate air leaks sometimes found with rotating seals
- > The annular piston is also designed to eliminate the oil blow back in the air exhaust line
- > The large piston area gives maximum hold-in force to reduce the possibility of jumping out of lock
- > Locking ring gives full 6mm positive engagement with side gear, again reducing the possibility of jumping out of lock
- > Gears have been redesigned for maximum strength and durability
- > The lock ring is made from high spec 300m steel to provide ultimate strength and ability to withstand shock loads
- > Locking actuator cage made from steel to withstand shock loading caused by power locking
- > Locker body turned from billet 817M40T (EN24T) to give optimum strength
- > Only change necessary to fit the locker is drill and tap the diff housing 1/4" bsp for the air feed fitting
- > No changes to the axle case
- > Requires on board air supply - not supplied

**DA1224**

Defender 90 - 1993 onwards	Front & Rear
Defender 110 - 1993 onwards	Front
Discovery 1 - 1993 - 1998	Front & Rear
Discovery 2	Front & Rear
Range Rover Classic - 1993 - 1996	Front & Rear

**DA1224SN**

Defender 110 - 2002 onwards (Wolf)	Rear
Range Rover P38	Front & Rear

**DA9011**

**Automatic Torque Biasing Limited Slip Differential**

Defender - 1993 onwards	Front & Rear
Discovery 1 - 1993 - 1998	Front & Rear
Discovery 2	Front & Rear
Range Rover Classic - 1993 - 1996	Front & Rear

**Note** - Not suitable for Salisbury axles.

- > Fully automatic - needs no driver input
- > Totally transparent on road, i.e., no unwanted adverse effects
- > Only comes into play when one wheel loses traction, i.e., a difference in wheel speed
- > Enhances the traction control as it multiplies the bias load created by the braking effect of the traction control
- > Needs no special oils
- > Needs no adjustment as the gears compensate for any wear that takes place
- > Only with 24 spline side gears



**Heavy-duty Crown Wheel & Pinions**

With the standard diff design, under extreme conditions, the front diff tries to climb out of full engagement under full power and then easily strips the teeth. Ashcroft has cut the gears in reverse for the front so they try to push together in mesh rather than push out so much stronger than the original design. Ashcroft looked at the materials used and compared these to the genuine materials used by Land Rover. The range are made from improved materials which is an improvement over the genuine specification. All pinions accept the later 24 spline drive flanges and have the female thread to accept the later type bolt (FS112301P) and washer (FTC5413), all ring gear threads are the stock 3/8 UNF, we stock the late flanges head high tensile bolts for these also FTC5150. Ashcroft have chosen to coat the crown wheel and pinions in chemical black to aid corrosion resistance and offer a unique appearance.

**DA1207** Front with reverse cut

Heavy-duty 4.12 ratio using a tooth count of 33 on the crown wheel and 8 teeth on the pinion.

Defender/Discovery 1/Range Rover Classic

**DA1508** Rear long pinion

Heavy-duty 4.12 ratio using a tooth count of 33 on the crown wheel and 8 teeth on the pinion.

Defender - up to 7A/Discovery 1/Range Rover Classic

Detroit

**Detroit Locker**

- > 100% locking differential
- > Legendary traction
- > Ultimate performance

The legendary Detroit Locker began the revolution in performance differentials and still leads the industry today as an Eaton brand. The Detroit Locker is the most durable and dependable locking differential available. The Detroit Locker maximises traction by delivering 100% of the torque to both drive wheels. It is engineered to keep both wheels in a constant drive mode, and has the ability to automatically allow wheel speed differentiation when required. No other performance differential has the reputation for delivering traction in mud, snow, rocks and on the track. The choice of professional racers and off-road enthusiasts around the world! The durability of the Detroit Locker is unmatched!

**DA5700**

Series 3/Defender/Discovery 1/Range Rover Classic 24 spline Rear

**DA5701**

Series 3/Defender/Discovery 1/Range Rover Classic 10 spline Rear

**DA5704**

Defender - Salisbury axle Detroit Locker 24 spline Rear



*"The choice of professional racers & off-road enthusiasts around the world"*



*"Recognised for its toughness as well as its smooth & quiet operation."*

**Detroit Truetrac**

- > Smooth operation
- > Performs open until needed
- > Fully automatic limited slip

The Detroit Truetrac was the first helical gear differential ever introduced into the automotive aftermarket as an Eaton brand. It remains the leading helical gear-type limited slip differential in the industry. Detroit Truetrac's proven helical gear design eliminates the need for wearable parts, resulting in maintenance free traction. Recognised not only for its toughness but also its smooth and quiet operation. Engineered to work efficiently in front and rear axles, semi-floating (C-clip axles) and transfer cases. Power transfer is so smooth, it literally goes unnoticed by the driver - even in front wheel drive axles. Proven design, low cost and effective performance, all make the Detroit Truetrac limited slip differential the ideal choice for a wide variety of vehicle applications. No maintenance - just traction!

**DA5705**

Series 3/Defender/Discovery 1 Range Rover Classic 10 spline Rear

**DA5709**

Series 3/Defender/Discovery 1/Discovery 2 Range Rover Classic 24 spline Rear

**DA5710**

Series 3/Defender/Discovery 1/Discovery 2 Range Rover Classic 24 spline Front

**DA5711**

Defender - Salisbury axle 24 spline Rear

**Diff Lock Lever Kit**



**DA1178**

Discovery 2  
Early Discovery 2's were not supplied with a centre diff lock function for the LT230 transfer case although the vehicles still have the centre diff lock installed in the transfer case. To get the diff lock function to work it just needs connecting. The linkage is easy to fit, cable operated and very neat. You attach the existing high/low stud to this new lever assembly. This kit will only work on transfer cases with serial numbers starting with either 41D or 42D.

**IMPORTANT**

When fitting a metric diff centre with metric bearings into an imperial casing you will require the additional following parts. Diffs went from imperial to metric in approximately 1983, take a look at one of the heads of the four large journal end cap bolts, if '8.8' is on the head it is metric, if not then it is imperial. Parts are required for fitting to both Truetrac or Detroit lockers.

<b>DA5712</b>	Spacer ring
<b>DA5713</b>	Imperial bearing sleeves
<b>RTC3095</b>	Bearings
	2 x bearings are required
<b>576521</b>	Longer bolts x 10



### First Aid & Travel Kits



For first aid & travel kit contents details  
[www.britpart.com/safety](http://www.britpart.com/safety)



**DA5076**  
**Mini First Aid Kit**  
 First aid kit stored in a lightweight, compact carry case. Great for people on the move and ideal for treating minor injuries. Contents are CE certified.

**DA5077**  
**Complete First Aid Kit**  
 First aid kit that includes a comprehensive range of essentials items stored away in a handy case. Ideal for the car, camping, home and travel. Contents are CE certified.

**DA5028**  
**European Travel Kit**  
 Includes essential items when travelling to Europe. All products are manufactured to UK required standards where applicable.

### Tyre Repair



**DA6652**  
**Emergency Tyre Kit**  
**12V Analogue Air Compressor**  
 > Pressure gauge in psi, Kg/cm<sup>2</sup>, bar  
 > Complete with 3 piece adapter kit for bikes, air beds and other inflatables  
 > Flexible air hose with screw valve connector  
 > Separate on/off power switch  
 > Fitted with fused 12v power plug  
**Analogue Tyre Pressure & Depth Gauge**  
 > Tyre pressure measurement in psi/bar  
 > Gauge range 0-120 psi/0-8bar  
 > Tread depth range 0-25mm



**DA6651**  
**Emergency Puncture Repair Sealant**  
 > 400ml tyre sealant  
 > The sealant is an equal mix of a hydrocarbon propellant and water based liquid latex  
 > 1 aerosol for one tyre, a single use product for tyres up to and including 16"  
 > A temporary repair designed to get you home no need for any tools or wheel changes  
 > For use on tubeless tyres only  
 > Will not repair tyres that have come off the rim, are ripped, have punctures larger than 5mm or have damaged walls



**DA2390**  
**Tyre Repair Kit**  
 Pack and leave an easy to use Britpart tyre repair kit in your vehicle.\* See the wheels section for more details on the tyre repair kit from Britpart.  
 \* Recommended for off-road use only.

**Tyre Repair Sealant**  
 > 400ml tyre sealant  
 > 1 aerosol for one tyre, a single use product for tyres up to and including 16"  
**Accessories**  
 1x pair protective gloves & 1x pair of cleaning wipes



**ARB Speedy Seal Kit**  
**DA8930** ARB Speedy Seal puncture repair kit  
**10100010** ARB Speedy Seal replacement cords x 50  
 Full details in ARB Compressor & Tyre Maintenance Section

**DA1890**  
**Replacement Tyre Sealant & Hose Kit**  
 Equivalent to LR072362 - 450ml sealant  
 LR016392 - adaptor hose  
 Freelander 2 - from EH384095  
 Range Rover Evoque - 2012 - from FH017663  
 Range Rover Evoque - 2019 onwards  
 Range Rover - L405 - from EA157922  
 Range Rover Sport - Mk2 - from EA348512  
 Range Rover Velar  
 Discovery Sport - from FH501420  
 Discovery 5

**Don't Get Stranded!**  
 Be prepared for a puncture or tyre deflation by carrying the right equipment.

### Recovery & Winching Kits



Britpart Pulling Power winching recovery kits come with all the basic items needed to ensure your winch can be used to the best effect. There is a choice of a starter or professional kit depending on your needs.  
**DB1015**  
 1x DB1000 Wheel chocks (pair)  
 1x DB1001 Winch kit bag  
 1x DB1002 Snatch block - 9,000kgs  
 1x DB1006 Tow strap - 8 ton, 60mm x 9m  
 1x DB1007 Tree strop  
 1x DB1010 Winching gloves  
 1x DB1011 Snatch tow sling - 8 ton  
 2x DB1012 Alloy bow shackle - 4.75 ton  
 1x DB1016 Winching blanket



**DB1017P**  
 1x DB1001 Winch kit bag  
 1x DB1002 Snatch block - 9,000kgs  
 1x DB1007 Tree strop  
 1x DB1010 Winching gloves  
 2x DB1012 Alloy bow shackle - 4.75 ton  
 2x DB1329 Jate rings



**RK9A**  
**DA8928**  
**ARB Essentials Recovery Kit**  
 1x 8,000kg snatch strap  
 1x 12,000kg tree trunk protector  
 1x 9,000kg snatch block  
 1x Snatch pack storage bag  
 1x Bow shackles

**DB1017**  
 1x DB1001 Winch kit bag  
 1x DB1002 Snatch block - 9,000kgs  
 1x DB1006 Tow strap - 8 ton, 60mm x 9m  
 1x DB1007 Tree strop  
 1x DB1010 Winching gloves  
 2x DB1012 Alloy bow shackle - 4.75 ton

**RK9A NEW**  
**ARB Premium Recovery Kit**  
 1x 8,000kg snatch strap  
 1x 12,000kg tree trunk protector  
 1x 4,500kg winch extension strap  
 1x 9,000kg competition snatch block  
 2x 4.75 ton Type "S" galvanized shackles  
 1x Recovery dampener  
 1x pair of leather gloves  
**RK12A**  
**ARB Weekender Recovery Kit**  
 1x 8,000kg recovery strap  
 2x 4.75 ton Type "S" 19mm galvanized shackles  
 1x Pair leather gloves

**ARB501A**  
**ARB Large Recovery Bag - bag only**  
**ARB503A**  
**ARB Compact Recovery Bag - bag only**  
**ARB504A**  
**ARB Micro Recovery Bag - bag only**  
**ARB504A**  
**ARB501A**

### Emergency Hammer

**Life Hammer - The Original**  
**DA6500**  
 > Double-sided steel hammer for shattering windows quickly and easily for a safe and quick exit from any vehicle  
 > Razor sharp blade cuts through seatbelts to ease escape  
 > Fluorescent button allows hammer to be located in the dark  
 > Installation mounting bracket ensures hammer is accessible when most needed



### Fire Extinguishers

**STC8138AB**  
 > 2kg kit  
 > Long-life - 100% polyester resin coated fire extinguisher  
 > Safe handling & crash proof fastening  
 > Readiness to operate displayed by manometer  
 > Precision brass valve



**STC8529AA**  
 > 1kg kit  
 > One-handed operation fire extinguisher  
 > High rating  
 > Checkable & re-chargeable  
 > With crash-tested bracket  
 > Attractive design  
 > Controlled discharge





Photo by Craig Orr

Jerry Cans



DA2166 Jerry can - 20ltr



DA2170 Jerry can - 20ltr stainless steel



DA2171 Jerry can - 10ltr stainless steel



DA2182 Jerry can holder for 20ltr cans



DA3414 NEW Flexible spout



DA2167 Spout



DA2172 Stainless steel spout

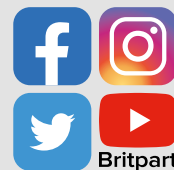

Long Range Fuel Tanks



DA4547 / DA4548

Defender 90

- > 30 litres (approximately) plastic flow tank
- > Lightweight
- > Supplied as kit
- > Easy to install & use
- > Requires no pumps or added fillers
- > Does not interfere with storage or clearance
- > Compatible with standard Defender fuel filler cap

DA4547

Defender 90 - Td5 & Tdci - up to 8A

DA4548

Defender 90 - Tdci - from 8A



DA4545

Defender 110

DA4545

- > Defender 110 - up to 1999 (pre-Td5 models)
- > Rear arch metal spare fuel tank - right hand side
- > 45 litres
- > Supplied with all the necessary fittings to install and use

DA4546

- > Defender 110 - 1999 onwards (Td5 & Puma models)
- > Rear arch metal spare fuel tank - right hand side
- > 45 litres
- > Supplied with all the necessary fittings as well as a replacement filler neck and specifically engineered bulkhead fitting for the balance pipe, having these makes the fitting of the tank quicker and easier as well as it working better too.

**Note** - Both above tanks are not suitable for use in a Defender 130. Additional bracket required for 7 seater - DA4546KIT.



DA4546

DA4546KIT

The long range fuel tank DA4546 will require this additional bracket when fitting to a 7-seater Defender.

*The best way of getting more fuel into your Defender without using valuable space or complex pumping systems!*

LongRanger Fuel Tanks

LongRanger fuel tanks are a safe and simple way to increase your vehicle's travelling range. Additional fuel capacity is essential for any Land Rover heading off into remote areas. The long range fuel tanks are designed with the latest CAD/CAM manufacturing processes. Using 2mm aluminiumised steel (14 gauge) as the material of choice for the fuel tanks, the tank is individually designed and tailored to suit each vehicle incorporating features such as internal baffling, anti surge dam, in-built expansion chamber and fully sealed brackets. Pre-drilled holes in mounting brackets for fast & easy installation. Fully baffled for better fuel usage & stronger tank design. Comprehensive fitting kit & instructions. More information available online

TA45

Defender - All Hard Top & Wagon Models

- > Fuel type: Diesel
- > Capacity: 80 litres
- > Fitting location: Right hand side sill, outside chassis rail
- > Filler location: Under drivers seat
- > Fuel transfer: 6 port valve - supplied in kit
- > Exhaust modifications: None
- > Other modifications: Sender unit supplied to interface with original gauge

TA62A

Discovery 3 & 4 - Diesel - excludes models with AdBlue

- > Fuel type: Diesel
- > Capacity: 104 litres - 186 litres in total when combined with factory 82 litres tank
- > Fitting location: In place of spare wheel behind rear diff
- > Filler location: Original, new dual filler neck supplied in kit to replace OEM
- > Fuel transfer: Transfer pump (supplied with automatic pump cut-off, gauge & sender unit)
- > Exhaust modifications: None
- > Other modifications: Spare wheel must be relocated, retains standard departure angle. Access to cargo area required to remove wheel winder (drawer units will be a problem). Fits with factory tow bar & Kaymar rear bar
- > Features: Automatic pump cut off. Fully baffled for better fuel usage and stronger tank design. Pre-drilled holes in mounting brackets for fast & easy installation.



TA62A



TA45



TA62A



### Incline Land Meters

#### Land Meters

- > Independent twin meter.
- > Convenient for seeing the pitching and rolling of the vehicle body or terrain.
- > Transparent illumination for easy-to-see readings at night.



**DA1003**  
Double incline land meter      Black



**DA1004**  
Double incline land meter      Carbon fibre effect

### Electronic Altimeter

#### DA1920

The 4x4 Altimeter on-dash integrated information display is a perfect match for any adventure on harsh and uneven terrain, providing data on the orientation of the vehicle (pitch angle, roll angle) as well as its speed. The bright display features an electronic compass for navigation and a light sensor to automatically adjust the device's back-light in line with the brightness outside. Since the altimeter connects via GPS, its speed, location and time measurements are far more accurate than could be achieved with the OEM vehicle read-outs and provide the driver with the information they need on any excursion.

- > Integrated speaker
- > Volume +/- & mute
- > Power on/off
- > Light sensor (automatically adjusts back-light brightness relative to outside brightness to reduce glare)
- > GPS icon (will show when successful GPS connection is established)
- > Current time (hours/minutes - automatically calibrated by GPS)
- > Voltage
- > Vehicle speed
- > Pitch angle
- > Roll/tilt angle
- > Elevation
- > Temperature (internal)
- > Electronic compass (calibrated by GPS)

#### Specification

Pitch angle:      -40° - +40°  
 Roll angle:      -40° - +40°  
 Temp. accuracy:    +/-1°C  
 Voltage  
 measurement range: DC 5-30V  
 Speed precision:    <0.36Km/h  
 Wireless transmission frequency: 2.4GHz  
 Operating temp:    -40°C - +80°C  
 Power supply:      DC 10V ~ 30V



*The perfect match for any adventure on harsh and uneven terrain*



Photo by Gareth H





Photo by Rob Bennett

ARB Jacks

1060001

ARB Hydraulic Jack

Adding a new dimension to traditional techniques, the long-travel ARB JACK is backed by the unique power of hydraulic technology. Kicking into action when even the lightest force is applied to the handle, the hydraulics will smoothly jack the vehicle up at up to 13mm increments with each downward manoeuvre. Whilst in action, a black rubber body bumper shields the vehicle from risk of damage during the recovery. The easy-to-access red lowering lever ensures lowering the vehicle is achieved swiftly and safely thanks to the two-stage descent feature and safety stop. Empowering the user with dual lowering speeds, with a press of the lever, a slow or rapid descent can be achieved.

Keeping A Low Profile

Carefully designed upon the importance of matching ergonomic form with safe and reliable function, the handle's high position and top pivot function provides users with ultimate control while preventing the need to uncomfortably kneel down in a deep trench to operate.

Ready For Heavy Lifting

JACK's body is made from hardy aircraft grade 6061 T6 aluminium and the shaft from military grade nitride for maximum strength and corrosion resistance. Running up the body, 9 locating points offer the adjustable hook a wide range of lifting heights; capable of lifting up to a total of 2,000kg. When under load, an internal blow-off valve provides overload protection to safeguard both JACK and most importantly, the user, from the dangerous consequence of the vehicle suddenly dropping if the working limit is exceeded.

Stand Your Ground With 360° Adjustability

Standing true to its adaptable character, JACK features an adjustable foot that can be rotated 360° via the shaft to match the angle of the terrain and reach a firm, stable connection between the base and ground surface.

Specifications

- Minimum lifting height: 160mm
- Maximum lifting height: 710 - 1,230mm
- Travel: 540 - 550mm
- Lifting range: 160 - 1,230mm
- Maximum capacity: 2,000kg
- Compressed height: 890mm
- Extended height: 1,432mm
- Weight: 10.5kg
- Lift per stroke: 13mm



ARB products available in the UK only.



72X10

ARB Exhaust X Jack

Total lift height - 750mm  
Total lift weight - 2 tonnes  
Bushranger® X Jack is designed and engineered to perfection. This award-winning product has a long history in the Australian landscape and put to the test many times. The X-Jack has a triple layer top with a hardcore for maximum protection and stability. The patented two-way inflation system can utilise exhaust or a portable air compressor inflation which provides added control in rate and extent of lift required. The X Jack assists lifting vehicle in a diverse range of situations or conditions such as sand, mud, snow or soft ground.  
**Dual inflation** - Dual alternatives for inflation provide the option of completing the inflation process by connecting a portable compressor to the X jack valve inlet or by the exhaust. (High temp hose included to 140°C.)  
**Quality construction** - The hard top integrated between two layers of reinforced PVC provides structure, reducing the risk of puncture during inflation and deflation.  
**Convenient** - Due to the X-Jacks inflatable nature, it goes anywhere, collapsing flat for easy storage into a heavy-duty storage bag.

Jackall



Features & Benefits

- > Patented 'safety link' mechanism which prevents abuse and misuse.
- > Heavy ribbed, extra large base which provides strength and greater load stability.
- > Cast components assures long life, trouble free operation.
- > Hot roll-formed, alloy steel beam which is strong and reliable.
- > Steel handle locks against beam for convenient storage.
- > Powder coated through and through which reduces scratching, greater corrosive resistance.

- DA3121 48" Jack (4ft) - 8,000lbs capacity
- DA3122 60" Jack (5ft) - 8,000lbs capacity
- DA3130 Top clamp
- DA4058 Maintenance kit
- DA4059 Jacking point adaptor
- DA4061 Mounting kit jack rack

Built with a patented 'Safety Link', the Maasdam Jackall is the 'Jack with More'! Larger base for greater stability. 'Safety Link' mechanism that prevents abuse, misuse and makes operations safer. Jacks come with a lifetime warranty and are built to current ANSI/ASME specifications. When safety and dependability matter most, continue to rely on Jackall.

Rugged & Pow'R-Full Jacks!

Anti-rattle Jack Clamps



- DA3153 Red
- DA3154 Black
- DA3155 Yellow

Jack Accessory



DA2244 Jacking point adaptor  
Allows the use of the jack with the standard jacking points on a Defender.  
Not compatible with Jackall jacks.



Bottle Jack



- ANR4489 Bottle jack kit (LR031924 & KAH000050)
- LR031924 Bottle jack
- KAH000050G Handle for bottle jack (LR031924)

Jack Bases

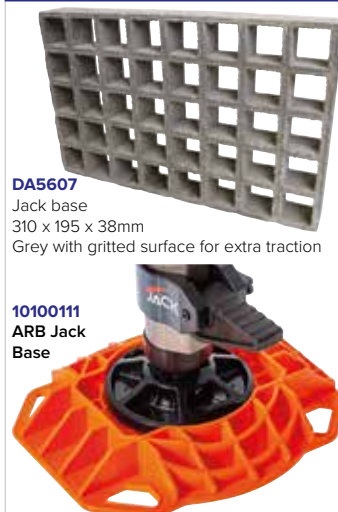

DA5607 Jack base  
310 x 195 x 38mm  
Grey with gritted surface for extra traction



- > 324 x 304 x 56mm
- > Provides a safer environment for the user
- > Alleviates sinkage on soft ground for safer use
- > 7000kg rated load capacity
- > Designed to suit your ARB Jack® or Hi-Lift™ and other suitable farm jacks.
- > Heavy-duty high-density polyethylene construction
- > High visibility safety orange
- > Non-slip textured pattern on bottom of the Jack Base for extra grip
- > Rugged construction meets all ARB standards for strength and durability
- > Can be mounted on a TRED™ Pro mounting kit or on the shaft of a Hi-Lift™ Jack using optional mounts (sold separately)
- > Easy and comfortable grab handle
- > Can be used as a rake to level terrain
- > Can be used as a wheel chock or jockey wheel receiver
- > Convenient leash attachment points for easy retrieval of the Jack Base after use (sold separately - TLOARB)
- > Designed and made in Australia



# OFF-ROAD

## Sand Ladder & Waffle Boards



**DA2231** Sandtrack Aluminium Pair  
1,500 L x 390 W x 4mm D  
**DA5600** Waffle boards Fibreglass Pair  
1,220 L x 270 W x 50mm D  
Grey with gritted surface for extra traction



**DA5601** Waffle boards Fibreglass Pair  
1,220 L x 270 W x 38mm D  
Grey with gritted surface for extra traction  
**DA4587** Recovery tracks Plastic Pair  
1,210 L x 325 W x 60mm D  
Stackable when not in use



Get yourself unstuck...

### ARB TRED Pro™ Recovery Boards

**TREDPROBB** Black/Black  
**TREDPROMGO** Grey/Orange

#### Features

- > Exotred™ unique and patented composite construction
- > Sipe-Lock™ patented grip profile
- > Unique nylon material for superior flex and durability
- > Special glass filled resin nylon teeth to reduce premature wear from wheel spin
- > Lower profile for stacking and storage
- > Retro fit mounts to suit most recovery board mounting options
- > Ergonomic handles for shovel control
- > Contour ramp with real 4x4 tyre data, dimensions and tread patterns for optimized design
- > The first recovery board to boast a lifetime warranty
- > Made by four-wheel drivers for four-wheel drivers
- > ARB unique colours and branding

#### Technical Specifications

- > CAD modelled 4X4 tyre patterns for the right traction in the right place
- > Unique two material composite over moulded construction
- > Patented composite 2-layer nylon design
- > Glass filled nylon teeth

#### Dimensions

- > 1,160 x 330 x 65mm
- > Nested/stacked height - (one set/pair) 85mm

### TLOARB

#### ARB TRED Pro™ Recovery Leash

Recovery leashes assist in locating your TRED Pros should they bury beyond sight after vehicle recovery. 1500mm length. Supplied as a pair.

### TPMK

#### ARB TRED Pro™ Mounting Kit

TRED Pro mounting bracket has been designed to perfectly suit and secure the TRED Pro recovery boards. Designed to be easy to mount in a variety of ways and allows you to mount two sets (pairs) perfectly nested. Built with off-road enthusiasts in mind, the TRED Pro mounting bracket is made from corrosion resistant materials and a robust, durable design to ensure it satisfies the rugged conditions of the great outdoors.

- > Corrosion resistant - made from the highest quality aluminium and polypropylene
- > Lockable - using a 6mm padlock you can protect your TRED Pros from theft
- > Quick release twist - for when you need to get your TRED Pro in a hurry
- > Easy & versatile installation - tie, bolt or screw to virtually anywhere

**Note** - TRED Pro mounting bracket comes as a single unit. Depending on your fitting requirements you may need to purchase two units. Fastening hardware not included.

### TPBAG

#### ARB TRED Pro™ Carry Bag

The TRED Pro carry bag is made from durable and waterproof canvas material. It features various gear storage pockets for your tow straps, shackles, winch blocks and anything else you need to carry. The extra-large front pocket is made from high quality UV stabilised mesh, great for keeping anything you need to dry out and doubles as a great rear wheel trash bag. The webbing straps will attach to your rear wheel carrier, roof racks and anywhere else you can strap it down, they also double as great backpack straps. There is no other recovery gear bag like it. The TRED Pro carry bag has been designed to hold one set/pair of TRED Pro recovery boards.

#### Dimensions

- (when full)
- Length - 1180mm
- Width - 360mm
- Depth - 100mm



**4X4 ACCESSORIES**

ARB products available in the UK only.



Special glass filled resin nylon teeth to reduce premature wear from wheel spin





Help to get yourself out of trouble...

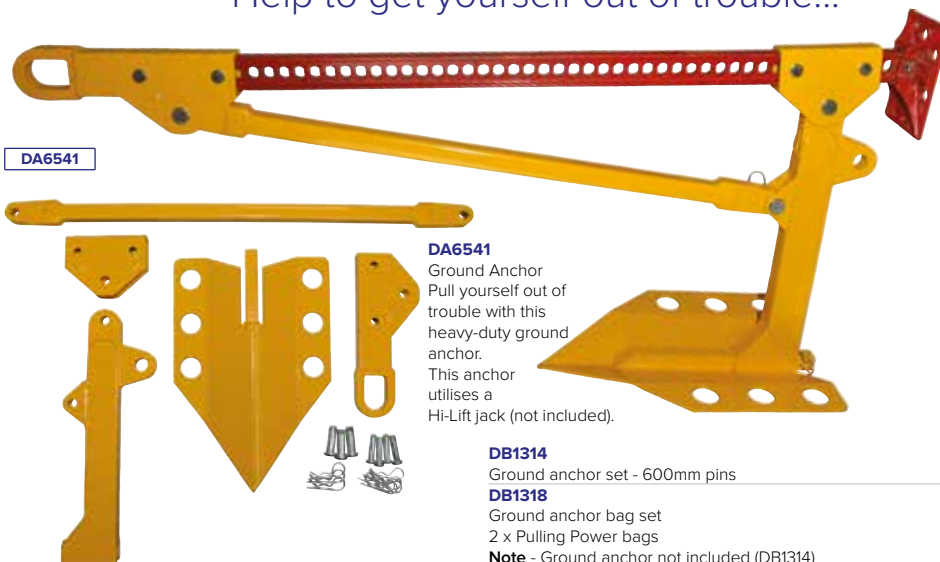

DA6541

**DA6541**  
Ground Anchor  
Pull yourself out of trouble with this heavy-duty ground anchor. This anchor utilises a Hi-Lift jack (not included).

**DB1314**  
Ground anchor set - 600mm pins

**DB1318**  
Ground anchor bag set  
2 x Pulling Power bags

**Note** - Ground anchor not included (DB1314)

DB1318



Photo by Marco Rojas

**Lift Rod Kit**



**DA7531**  
Fully adjustable suspension lift rod kit  
Discovery 3/Discovery 4/Range Rover Sport - 2005 - 2013

*“The ease of changing the ride height is what separates these rods from others in the marketplace.”*

These adjustable rods replace the plastic and rubber parts Land Rover supply on the vehicle. Made from aluminium with an industrial heavy grade rubber bushing, the aluminium parts are anodised black to help with corrosion protection and blending in when in the garage for work.

The lift rods have two settings; standard and off-road. With the air suspension set to normal driving height the lengthened rods will give you standard road and off road driving heights. If you shorten the rods the standard ride height will be approx 50mm higher. If you select off-road height the vehicle will be in the 'super extended' position.

No tools are required and should take no more than 2 minutes to do all four rods.

Access to the front is over the front wheels and for the back is through the rear wishbones (blanket required!)

**Note** - If run for a long time in off-road position then wheels may need realigning.



### Raised Air Intakes - Safari

Pioneered in Australia in the early 1980's, Safari Snorkels were born out of a need to protect 4WD engines from the hazards of dust and water commonly encountered in touring and off road applications.

Safari snorkels are manufactured to the highest standards in durable, UV stable, cross linked polyethylene material, using stainless steel hardware where appropriate. Each system includes quality fixtures and fittings, which offer superior sealing, presentation and long-term durability.

In arguably the best, if not toughest environment, Safari Snorkel Systems are thoroughly researched, tested and tooled for each model of Land Rover. The Safari Snorkel delivers a continuous and cooler supply of air for maximum engine performance. It is positively sealed as well to ensure the best protection against deep water crossings and dust.

Defender	Snorkel fitment side	Discovery	Snorkel fitment side
<b>DA3024</b>		<b>DA3015</b>	
Defender - 200Tdi - 1990 - 1994	LHS	Discovery 1 - 200Tdi - 1990 - 1994	LHS
<b>DA3026</b>		<b>DA3018</b>	
Defender - 300Tdi - 1994 - 1999	RHS	Discovery 1 - V8 - 1990 - 1994	LHS
May require slight modification for LHD vehicles		<b>DA3020</b>	
<b>DA3069</b>		Discovery 1 - 300Tdi (non-EGR)	LHS
Defender - Td5 - 1999 onwards	RHS	Discovery 1 - V8 - 1994 - 1999 (non-ABS)	LHS
Defender - 2007 onwards		<b>DA3022</b>	
<b>DA2374</b>		Discovery 1 - 300Tdi (non-EGR)	LHS
Stainless steel air ram grille. Shown attached to air ram - grille only. Will not fit DA3069 snorkel.		Discovery 1 - V8 - 1994 - 1999 (ABS)	LHS
<b>DA3141</b>		<b>DA3023</b>	
3" replacement air ram for DA3024		Discovery 2 - Td5	LHS
<b>DA3142</b>		Discovery 2 - V8 - 1999 onwards	LHS
3½" replacement air ram for DA3026, DA3027, DA3027LH, DA3069		<b>DA3021</b>	
<b>Note</b> - Fitment from seated internal view - RHS - right hand side and LHS - left hand side.		Discovery 3 - TdV6 SE/Discovery 4 - TdV6	RHS
		<b>DA2374</b>	
		Stainless steel air ram grille.	
		Shown attached to air ram - grille only.	
		<b>DA3141</b>	
		3" replacement air ram for DA3015, DA3018, DA3020, DA3022, DA3023	
		<b>DA3142</b>	
		3½" replacement air ram for DA3021	
		<b>Note</b> - Fitment from seated internal view - RHS - right hand side LHS - left hand side.	



Safari snorkels are manufactured to the highest standards in durable, UV stable, cross linked polyethylene material.

For more Safari Snorkel pictures visit - [www.britpart.com/safari](http://www.britpart.com/safari)

DA3141 / DA3142



### Raised Air Intakes - Britpart



*If you're likely to be driving your Land Rover in circumstances which could mean wading in deep water or driving in very dusty conditions then you should consider fitting a raised air intake to your vehicle.*

This version from Britpart is a classic mushroom-top snorkel for Defender. Featuring heavy-duty metal pipe work, cyclone pre-cleaner and a durable attractive matt black finish.

<b>DA2225</b>	Defender - 300Tdi/Td5/2007 onwards
<b>DA2225PIPE NEW</b>	Replacement flexible pipe for DA2225
<b>NRC6920</b>	Raised air intake cleaner for DA2225 Inside diameter - 64mm

#### DA1966

#### XS Snorkel Head

An easy to install enhancement for any Safari or Britpart snorkel. Compliments the Britpart XS range of air vents and grilles.



### Raised Air Intake - Land Rover



#### VPLEP0435LR

Defender 2020 - 90 & 110  
Anthratic coloured finish  
Manufactured from high-quality, durable plastic.  
Secured to Defender's 'A' post and utilises the existing air vent fixings.  
Note - Does not extend the Defender's wading capability past the standard depth of 900mm.

### Raised Air Intake - Safety Devices



#### DA2985

Safety Devices 3" raised air intake which fits the following Safety Devices roll cages - L108, L172, L185, L190, L213, L227, L242, L243, L247, L249, L258, L259, L260. **Note** - Excludes 3" raised air intake head.



# WINCHES



Get To Where You  
Want To Go



### Britpart Winches



on all  
Britpart  
Winches



If you are serious about off-roading then a winch is an essential piece of kit. They are indispensable when getting yourself and others out of tricky situations.

The Britpart Pulling Power range of powerful and reliable electric winches all feature a planetary gear system for fast line speed, free spooling, power in & power out and low electric current. Now with the larger winches you have a choice of having the traditional steel cable fitted or Dyneema rope.

A full range of winching equipment is also available from Britpart - including; safety gear, bumpers, chocks, hooks, shackles & ropes.

Together with the winches you'll be able to 'Get to where you want to go!'



Features	DB12000i	DB9500i	DB6000	DB2000
<b>Motors</b>	3.6Kw (4.8Hp) Heavy-duty series wound DC motor	3.6Kw (4.8Hp) Heavy-duty series wound DC motor	2.7Kw (3.6Hp) Permanent magnetic DC motor	1.0Kw (1.5Hp) Permanent magnetic DC motor
<b>Volts Available</b>	12 volts & 24 volts	12 volts & 24 volts	12 volts	12 volts
<b>Steel Cable or Dyneema Rope</b>	Steel cable or Dyneema rope	Steel cable or Dyneema rope	Steel cable	Steel cable
<b>Waterproofness &amp; Dustproofness</b>	Winch Motor - Rated at IP67 For waterproofness & dustproofness Winch Solenoid - Rated at IP54 For dustproofness	Winch Motor - Rated at IP67 For waterproofness & dustproofness Winch Solenoid - Rated at IP54 For dustproofness	Winch Motor - Rated at IP67 For waterproofness & dustproofness Winch Solenoid - Rated at IP54 For dustproofness	Winch Motor - Rated at IP65 For waterproofness & dustproofness Winch Solenoid - Rated at IP65 For dustproofness
<b>Planetary Gear System for Fast Line Speed</b>	✓	✓	✓	✓
<b>Automatic Load Holding Brake</b>	✓	✓	✓	✓
<b>Free Spooling</b>	✓	✓	✓	✓
<b>Power In &amp; Power Out</b>	✓	✓	✓	✓
<b>Low Electric Current</b>	✓	✓	✓	✓
<b>Hardened Drum</b>	✓	✓		

### Specifications

<b>Rated Line Pull - single line</b>	5,443kgs 12,000lbs	4,309kgs 9,500lbs	2,722kgs 6,000lbs	907kgs 2,000lbs
<b>Gear Reduction Ratio</b>	294:1	212:1	210:1	153:1
<b>Motor Size</b>	3.6Kw 4.8Hp	3.6Kw 4.8Hp	2.7Kw 3.6Hp	1.0Kw 1.5Hp
<b>Drum Size - D x L</b>	67 x 228mm 2.64 x 9"	67 x 228mm 2.64 x 9"	63 x 140mm 2.5 x 5.51"	32 x 71mm 1.26 x 2.8"
<b>Steel Cable - size</b>	9.53mm x 30.5m 0.38" x 100'	9.53mm x 30.5m 0.38" x 100'	7.94mm x 26m 0.31" x 85'	4mm x 15.2m 0.16" x 50'
<b>Dyneema Rope - size</b>	11mm x 28m 0.43" x 91.9'	11mm x 28m 0.43" x 91.9'	N/A	N/A
<b>Overall Dimensions - L x W x H</b>	548 x 167 x 299mm 21.57 x 6.57 x 11.77"	548 x 167 x 299mm 21.57 x 6.57 x 11.77"	438 x 158 x 185mm 17.24 x 6.22 x 7.28"	320 x 105 x 111mm 12.6 x 4.13 x 4.35"
<b>Steel Cable - net weight</b>	43.0kgs 94.8lbs	43.0kgs 94.8lbs	31.8kgs 70.0lbs	6.6kgs 14.6lbs
<b>Dyneema Rope - net weight</b>	33.0kgs 72.8lbs	33.0kgs 72.8lbs	N/A	N/A
<b>Mounting Bolt Pattern</b>	254 x 114.3mm 10 x 4.5"	254 x 114.3mm 10 x 4.5"	166 x 114.3mm 6.54 x 4.5"	48 x 76mm 1.89 x 3.0"



### Britpart Winches

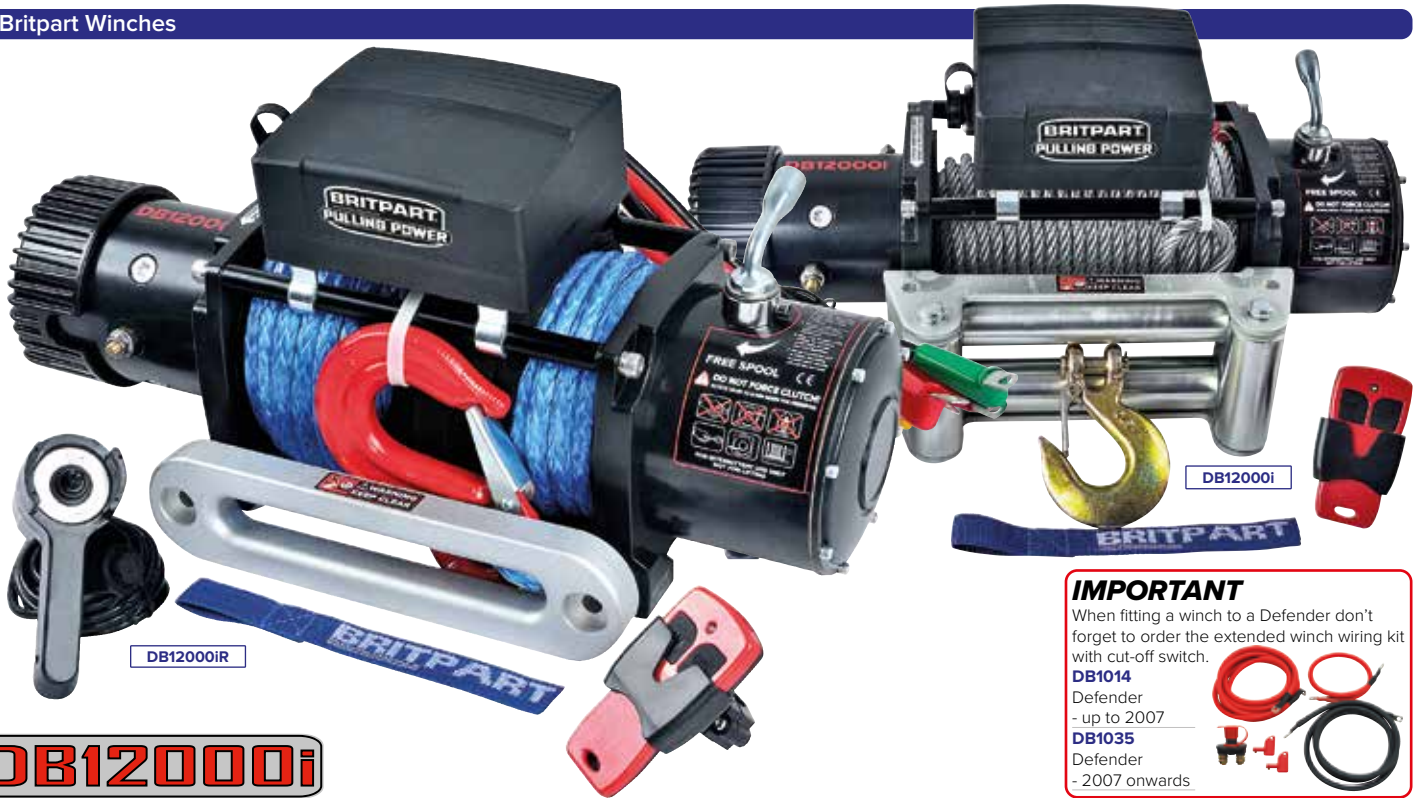

## DB12000i

### IMPORTANT

When fitting a winch to a Defender don't forget to order the extended winch wiring kit with cut-off switch.

**DB1014**

Defender  
- up to 2007

**DB1035**

Defender  
- 2007 onwards



Performance of 1st Layer								Line Pull & Cable/Rope Capacity by Layer							
Line Pull		Line Speed				Motor Current		Rope Layer	Rated Line Pull		Rope Capacity				
		12 volt		24 volt		12 volt	24 volt				Steel Cable		Dyneema Rope		
Lbs	Kg	Fpm	Mpm	Fpm	Mpm	Amp	Amp	Lbs	Kg	Feet	Meters	Feet	Meters		
0	0	14.0	4.2	16.8	5.1	90	68								
4,000	1,816	9.2	2.8	11.3	3.5	190	140	1	12,000	5,448	15.0	5.0	13.8	4.2	
6,000	2,724	7.9	2.4	9.5	2.9	230	165	2	10,200	4,631	38.0	11.5	31.2	9.5	
8,000	3,632	6.9	2.1	8.4	2.5	260	190	3	8,400	3,814	64.0	19.5	51.5	15.7	
10,000	4,540	6.5	2.0	7.8	2.4	300	220	4	7,300	3,314	95.0	29.0	76.4	23.3	
12,000	5,448	5.9	1.8	7.0	2.2	330	245	5	6,500	2,950	100.0	30.5	91.9	28.0	

**Galvanised aircraft cable with break force - 14,400lbs**

<b>DB12000i</b>	12 volt
<b>DB12000i24</b>	24 volt

**Dyneema rope with break force - 25,800lbs**

<b>DB12000iR</b>	12 volt
<b>DB12000i24R</b>	24 volt

## DB9500i



### IMPORTANT

When fitting a winch to a Defender don't forget to order the extended winch wiring kit with cut-off switch.

**DB1014**

Defender  
- up to 2007

**DB1035**

Defender  
- 2007 onwards



Performance of 1st Layer								Line Pull & Cable/Rope Capacity by Layer							
Line Pull		Line Speed				Motor Current		Rope Layer	Rated Line Pull		Rope Capacity				
		12 volt		24 volt		12 volt	24 volt				Steel Cable		Dyneema Rope		
Lbs	Kg	Fpm	Mpm	Fpm	Mpm	Amp	Amp	Lbs	Kg	Feet	Meters	Feet	Meters		
0	0	19.0	5.8	22.5	6.9	110	85								
4,000	1,816	12.5	3.8	14.8	4.5	210	145	1	9,500	4,309	15.0	5.0	13.8	4.2	
6,000	2,724	10.5	3.2	12.5	3.8	260	190	2	7,500	3,402	38.0	11.5	31.2	9.5	
8,000	3,632	8.6	2.6	10.5	3.2	300	220	3	6,200	2,812	64.0	19.5	51.5	15.7	
9,500	4,313	7.9	2.4	9.2	2.8	350	275	4	5,300	2,404	95.0	29.0	76.4	23.3	
								5	4,630	2,100	100.0	30.5	91.9	28.0	

**Galvanised aircraft cable with break force - 14,400lbs**

<b>DB9500i</b>	12 volt
<b>DB9500i24</b>	24 volt

**Dyneema rope with break force - 25,800lbs**

<b>DB9500iR</b>	12 volt
-----------------	---------



# WINCHES

## Winches

### Britpart Winches

# DB6000



#### Performance of 1st Layer

Line Pull		Line Speed		Motor Current
Lbs	Kg	Fpm	Mpm	Amp
0	0	15.0	4.6	30
1,000	454	11.5	3.5	80
3,000	1,361	9.0	2.7	120
5,000	2,268	7.0	2.0	170
6,000	2,722	4.9	1.5	210

#### Line Pull & Cable Capacity by Layer

Rope Layer	Rated Line Pull		Rope Capacity	
	Lbs	Kg	Feet	Meters
1	6,000	2,722	12.7	3.9
2	5,000	2,268	27.5	8.4
3	4,250	1,928	44.0	13.4
4	3,720	1,687	64.0	19.5
5	3,300	1,497	85.0	25.9

Galvanised aircraft cable with break force - 10,000lbs  
**DB6000**  
 Britpart 6,000lbs winch  
 12 volt



on all  
**Britpart Winches**

#### IMPORTANT

When fitting a winch to a Defender don't forget to order the extended winch wiring kit with cut-off switch.

**DB1014**

Defender  
 - up to 2007

**DB1035**

Defender  
 - 2007 onwards



Britpart DB2000 fitted to a working model of a Land Rover

# DB2000

Cable with break force - 4,000lbs  
**DB2000**  
 Britpart 2,000lbs winch  
 Includes tension plate to prevent rope entanglement

12 volt

#### Performance of 1st Layer

Line Pull		Line Speed		Motor Current
Lbs	Kg	Fpm	Mpm	Amp
0	0	14.0	4.3	14
1,000	454	9.0	2.7	60
1,500	680	7.5	2.3	90
2,000	907	5.9	1.8	115

#### Line Pull & Rope Capacity by Layer

Rope Layer	Rated Line Pull		Rope Capacity Steel Cable	
	Lbs	Kg	Feet	Meters
1	2,000	907	6.0	1.8
2	1,636	742	13.0	4.0
3	1,385	628	22.0	6.7
4	1,200	544	33.0	10.0
5	1,059	480	44.0	13.4
6	947	430	50.0	15.2

#### Important

Winch suitable for small vehicles and trailer applications only.



Photo by Matt Whitehall



Winch Spare Parts

**DB12000i** **DB9500i** **DB9000C** **DB8000** **DB6000** **DB2000**

Winch motor	DB1300	DB1300	DB1332	DB1301	DB1337	N/A
Solenoid assembly	DB1303 DB1360 <small>NEW - DB12000IR</small>	DB1303	DB1302	DB1302	DB1336	N/A
Brake service kit	DB1304	DB1304	DB1304	N/A	DB1338	N/A
Roller fairlead	DB1307 180mm aperture	DB1307 180mm aperture	DB1307 180mm aperture	DB1307 180mm aperture	DB1341 105mm aperture	N/A
Winch cable & hook	DB1328	DB1328	DB1328	DB1328	DB1339	DB1354
Winch cable hook	DB1328H	DB1328H	DB1328H	DB1328H	N/A	N/A
Winch rope & hook	DB1309	DB1309	DB1309	DB1309	N/A	N/A
Brush & holder set	DB1330	DB1330	DB1331	DB1331	DB1340	N/A
Remote control	DB1355 - rocker - 4-pin DB1334 - toggle - 3-pin	DB1355 - rocker - 4-pin DB1334 - toggle - 3-pin	DB1355 - rocker - 4-pin DB1334 - toggle - 3-pin	DB1355 - rocker - 4-pin DB1334 - toggle - 3-pin	DB1355 - rocker - 4-pin DB1334 - toggle - 3-pin	DB1343
Remote control socket upgrade kit From 15mm to 20mm with remote control.	DB1356 - rocker - 4-pin DB1352 - toggle - 3-pin	DB1356 - rocker - 4-pin DB1352 - toggle - 3-pin	DB1356 - rocker - 4-pin DB1352 - toggle - 3-pin	DB1356 - rocker - 4-pin DB1352 - toggle - 3-pin	DB1356 - rocker - 4-pin DB1352 - toggle - 3-pin	N/A
Remote control socket upgrade/repair From 15mm to 20mm	DB1352R - 3-pin DB1355R - 4-pin Can also be used to repair existing 20mm socket	DB1352R - 3-pin DB1355R - 4-pin Can also be used to repair existing 20mm socket	DB1352R - 3-pin DB1355R - 4-pin Can also be used to repair existing 20mm socket	DB1352R - 3-pin DB1355R - 4-pin Can also be used to repair existing 20mm socket	DB1352R - 3-pin DB1355R - 4-pin Can also be used to repair existing 20mm socket	N/A



DB1301



DB1328H



DB1356



DB1303



DB1302



DB1304



DB1307



DB1330



DB1334



DB1352R



DB1309

**DB1309**  
12 strand synthetic HMPE fibre replacement winch rope  
11mm x 28m  
Breaking point - 25,800lbs

- > Very light
- > Very strong
- > Easy to handle
- > Easily spliced
- > Does not curl
- > Floats

- > Highly visible
- > Compact
- > Does not kink
- > Less effort in use
- > Safety in use

For more images of the winch spare parts  
[www.britpart.com/winchparts](http://www.britpart.com/winchparts)



Britpart offer a full range of **service kits with oil.**  
See Service Kits section for more details.



# WINCHES

## Winch Bumpers

### Winch Bumpers

#### Tubular Winch Bumpers



DA5609



DA5622



DA5604

#### Standard Winch Bumpers



DA5681



DA5623



DA5643



DA5621



DA5620



DA5645



DA7537



DA5691



DA5691

Discovery 3 winch bumper  
This impressive winch bumper is manufactured from 5mm steel and all the appropriate mounting brackets are made with 10mm steel. Smart powder coated matt black finish. Supplied with fog lights & aluminium washer bottle.

#### Tubular Winch Bumpers

- > Stylish tubular steel space-frame construction for strength
- > Extremely close fitting for maximum approach angle
- > Compatible with many steering guards
- > Built-in high-lift jacking points
- > Integral rock guard
- > Supplied with full fitting kit

**Note** - Grille will need modifying

**DA5609** Defender - air-con Black

Suitable for DB12000i & DB9500i winches

**DA5622** Defender - non air-con Black

Suitable for DB12000i & DB9500i winches

**DA5604** Discovery 1 Black

Suitable for DB12000i & DB9500i winches

**Note** - Grille needs trimming for fitment to air-con & automatic vehicles

#### Standard Winch Bumpers

- > Heavy-duty steel winch bumpers

**DA5620** Defender - non air-con Black

Suitable for DB12000i & DB9500i winches

**DA5681** Defender - non air-con Galvanised

Suitable for DB12000i & DB9500i winches

**DA5623** Defender - air-con Black

Suitable for DB12000i & DB9500i winches

**DA5643** Defender - air-con Black

Suitable for Warn XD9000 and XD9.5 winches

**DA5621** Discovery 1/Range Rover Classic Black

**Note** - For vehicles without air-con and/or without transmission oil coolers fitted.

Suitable for DB12000i & DB9500i winches

**DA5645** Discovery 2 Black

- > One piece bumper manufactured from 5mm steel with wrap around sides to protect the wings

- > Fixed to standard mounting points with provisions for 2 swivel recovery points and 2 Hi-Lift jacking points

**Note** - Grille needs trimming to fit winch

Suitable for DB12000i & DB9500i winches

#### Discreet Winch Bumper

- > Suitable for any low line winch
- > Made from 6mm and 8mm steel
- > Discreetly fits behind the existing bumper
- > Bolts directly onto the front cross member using existing holes
- > Modifications to bumper are required, includes instructions
- > Excludes fairlead

**Note** - Low line winch needs to have a removable solenoid.

#### DA7537

Discovery 3 - TdV6 & V8/Discovery 4 - TdV6 & V8  
Range Rover Sport - TdV6 & V8





**Demountable Low Line Winch Tray**

**DA2897**  
D44 demountable winch tray, utilising the 2" receiver standard. Constructed from 5mm steel and laser cut section, finished in black powder-coat. Designed to accept the Britpart Pulling Power and other major brand winches with the industry standard 254mm x 114.3mm bolt pattern where the overall depth is less than 195mm.



**Winch Bumper Kits**

*Britpart have all the kits you need to help you to get winching*

**Standard Bumper**



**Standard Galvanised Bumper**



**Tubular Bumper**



**Standard Bumpers**

<b>DB1313</b>	Defender - non air-con	Steel Cable	DB12000i winch
<b>DB1313R</b>	Defender - non air-con	Dyneema Rope	DB12000i winch
<b>DB1344</b>	Defender - air-con	Steel Cable	DB12000i winch
<b>DB1344R</b>	Defender - air-con	Dyneema Rope	DB12000i winch
<b>DB1313-24V</b>	Defender - non air-con	Steel Cable	DB12000i winch - 24 volt
<b>DB1310</b>	Defender - non air-con	Steel Cable	DB9500i winch
<b>DB1310R</b>	Defender - non air-con	Dyneema Rope	DB9500i winch
<b>DB1345</b>	Defender - air-con	Steel Cable	DB9500i winch
<b>DB1345R</b>	Defender - air-con	Dyneema Rope	DB9500i winch
<b>DB1325</b>	Discovery 1/Range Rover Classic	Steel Cable	DB12000i winch
<b>DB1325R</b>	Discovery 1/Range Rover Classic	Dyneema Rope	DB12000i winch
<b>DB1324</b>	Discovery 1/Range Rover Classic	Steel Cable	DB9500i winch
<b>DB1324R</b>	Discovery 1/Range Rover Classic	Dyneema Rope	DB9500i winch
<b>DB1346</b>	Discovery 2	Steel Cable	DB12000i winch
<b>DB1346R</b>	Discovery 2	Dyneema Rope	DB12000i winch
<b>DB1347</b>	Discovery 2	Steel Cable	DB9500i winch
<b>DB1347R</b>	Discovery 2	Dyneema Rope	DB9500i winch

**Note** - DB1324, DB1325, DB1324R & DB1325R are for vehicles without air-con and/or without transmission oil coolers fitted.

**Galvanised Standard Bumpers**

<b>DB1313GALV</b>	Defender - non air-con	Steel Cable	DB12000i winch
<b>DB1313RGALV</b>	Defender - non air-con	Dyneema Rope	DB12000i winch
<b>DB1310GALV</b>	Defender - non air-con	Steel Cable	DB9500i winch
<b>DB1310RGALV</b>	Defender - non air-con	Dyneema Rope	DB9500i winch

**Tubular Bumpers**

<b>DB1319</b>	Defender - non air-con	Steel Cable	DB12000i winch
<b>DB1319R</b>	Defender - non air-con	Dyneema Rope	DB12000i winch
<b>DB1321</b>	Defender - air-con	Steel Cable	DB12000i winch
<b>DB1321R</b>	Defender - air-con	Dyneema Rope	DB12000i winch
<b>DB1348</b>	Defender - non air-con	Steel Cable	DB9500i winch
<b>DB1348R</b>	Defender - non air-con	Dyneema Rope	DB9500i winch
<b>DB1349</b>	Defender - air-con	Steel Cable	DB9500i winch
<b>DB1349R</b>	Defender - air-con	Dyneema Rope	DB9500i winch
<b>DB1320</b>	Discovery 1	Steel Cable	DB12000i winch
<b>DB1320R</b>	Discovery 1	Dyneema Rope	DB12000i winch
<b>DB1350</b>	Discovery 1	Steel Cable	DB9500i winch
<b>DB1350R</b>	Discovery 1	Dyneema Rope	DB9500i winch

**Note** - DB1320, DB1350, DB1320R & DB1350R the grille needs trimming for fitting to air-con & automatic vehicles.

*Defender winch bumper kits all include the extended wiring kit including safety cut-off switch kit (DB1014)*



**DB1321**



**DB1344R**



**DB1313GALV**



**DB1320**



**DB1325**

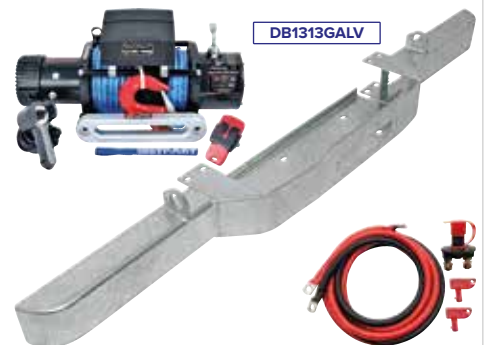

**DB1349R**

**Bumper Fitting Kits**



**DA1171K**  
Easier fitment plates which replace the standard fitted spring clip plates. With stainless steel bolt set.

**DA1171**  
Easier fitment plates which replace the standard fitted spring clip plates. Without bolt set.



**ALQ710040K**  
Tapping blocks & stainless steel bolt set  
**DA1269**  
Tapping blocks & bumper bolt kit  
**DA1268**  
Bumper bolt kit



**DA5621K**  
Discovery 1/Range Rover Classic  
Replacement fitting kit for winch bumper - DA5621

**DA5621K**



# WINCHES

## Winch Accessories

### Fairleads

255mm Mounting Holes			
DB1003	Hawse fairlead	Steel	215mm aperture
DB1004	Hawse fairlead	Steel	130mm aperture
DB1315	Hawse fairlead	Aluminium	205mm aperture
DB1317	Hawse fairlead	Stainless steel	205mm aperture
DB1316	Roller fairlead	Stainless steel	180mm aperture
DB1307	Roller fairlead	Zinc coated	180mm aperture
DB1341	Roller fairlead	Zinc coated	105mm aperture
125mm Mounting Holes			
DB1005	Hawse fairlead	Steel	80mm aperture

### Ropes & Straps

DB1007	Tree strop	4t SP	1.6m x 120mm
DB1006	Tow strap	8t WLL	9m x 60mm
DB1011	High elasticity tow sling	8t WLL	9m x 60mm
DA3028	Rope - polypropylene	8t MBL	5m x 24mm
DA3029	Rope - nylon	12t MBL	5m x 24mm
DA3030	Kinetic recovery rope - octoplaît	12t MBL	5m x 24mm
DA3031	Kinetic recovery rope - octoplaît	12t MBL	8m x 24mm

**Note** - SP = straight pull; WLL = working load limit; MBL = maximum breaking load

#### 2 Ton Flat Webbing Sling - Green

This soft and light polyester product reduces the chance of damage during use. The reinforced eyes make the sling both secure and reliable. Tested on a 7:1 breaking strain factor, this flat webbing sling ensures that the item is safe to lift a weight of 2 ton or less. Sling will come with the safe load limit, date of manufacture, serial number and test certification.

	Length	Width	Breaking Strain
DA1278	3,000mm	60mm	2,000kg
DA1279	5,000mm	60mm	2,000kg

#### 3 Ton Flat Webbing Sling - Yellow

Crafted from polyester to give you a lighter alternative to chain and rope solutions. They are easy to pack away and store, making your life that little bit easier! The sling is coloured in line with EU safety standards with yellow representing a 3 ton loading limit. These webbing slings have been carefully tested on a 7:1 breaking stress factor to confirm that they can safely handle the 3 ton safe loading limit. Sling will come with the safe load limit, date of manufacture, serial number and test certification.

	Length	Width	Breaking Strain
DA1280	3,000mm	90mm	3,000kg
DA1281	4,000mm	90mm	3,000kg
DA1282	6,000mm	90mm	3,000kg

#### Tow Strap - Loop and Loop - Orange

Flat polyester tow strap is lighter than chain and rope equipment, giving you the flexibility to take it with you wherever you go. It is ideal for towing and pulling vans, caravans, cars and agricultural vehicles.

	Length	Width	Breaking Strain
DA1283	8,000mm	50mm	5,000kg

**ARB Recovery Equipment**  
Much more information online.



#### SNATCH STRAP



#### WINCH EXTENSION STRAP



#### TREE TRUNK PROTECTOR



Snatch Straps	Min. Brake Strain	Length	Width
ARB705	20%	9m	60mm
ARB710		9m	80mm
ARB715		9m	110mm

#### Winch Extension Straps

Reinforced eyes. 100% polyester with eye & seam protector sleeves	Length	Width
ARB720	20m	55mm
ARB725	20m	80mm

#### Tree Trunk Protectors

Reinforced eyes. 100% polyester with eye & seam protector sleeves	Length	Width
ARB730	3m	80mm
ARB735	5m	80mm

ARB products available in the UK only.



Shackles & Pulleys



**DA7336**  
**12-Strand Shackles**

Pair  
Breaking load - 5,830kgs  
Manufactured from 11mm 12-strand UHMWPE rope with built in UV inhibitor. These are a lightweight, easy and safe way of joining ropes and strops. Due to the much lower kinetic energy being stored, using these shackles is much safer in the event of a rope or strop failure. Can also be used to attach ropes to standard towing eyes without scratching the paintwork.

See how easy it is to use these shackles

[www.britpart.com/DA7336](http://www.britpart.com/DA7336)



**ARB2018**  
**ARB Soft Connect Shackle**

Staying safe is paramount in a recovery situation. Having gear that is correctly rated protects your family, friends and vehicle, and of course should be front of mind when selecting recovery equipment for your situation. Manufactured using UHMWPE (Ultra High Molecule Weight Polyethylene) high tensile CE certified synthetic rope, is ARB's updated Soft Connect Shackle. UHMWPE rope is used in many of the synthetic rope applications on winches and purpose-built tow straps. Rated at 14.5T breaking strength, the ARB Soft Connect Shackle is engineered to float in water, be resistant to short term UV radiation and provide superior strength. Updating the protection to the rope, the UHMWPE synthetic rope is encased in a high tensile braided shield. The braided shield provides improved abrasion resistance when in use.

**Features**

- > 14.5T(31,967lbs) breaking strength, suitable for vehicles up to 3.5T (7,716lbs)
- > UV resistant properties + water resistant & designed to float
- > Braided outside shield
- > Longer size to suit more conditions
- > Slide lock loop, no draw string

- > Attaches to most rated recovery points
- > Manufactured from CE certified high tensile UHMWPE (ISO 2307)
- > Safer than a steel shackle when used correctly
- > Instructions printed on storage bag, as well as included in handy print form
- > Fits in most storage spots in your vehicle, door pockets, glove boxes & no rattles

**Technical Specifications**

- > UHMWPE (ISO 2307) synthetic rope
- > 12mm x 12 strand rope
- > Tested in house & externally to ARB's stringent requirements
- > Consistent 14.5T+ (142kN+) breaking point in a controlled environment
- > All shipments batch tested for consistency under ARB test conditions
- > Comprehensive testing in field – Winching, Snatch Blocks & Snatch Strap
- > Braided sleeve for superior abrasion resistance
- > Not for lifting purposes
- > Suitable for vehicles using an 8T or 11T recovery strap
- > 780mm length & 235g



**DA3160** Swivel recovery eye - stainless steel - 36mm diameter & shackle (3/4 tons)

**Note** - Not suitable for standard Land Rover bumpers

**DA3160A** Replacement shackle for DA3160

**DB1009** Shackle - 1.4 ton

**DB1353** 'D' shackle - 1.4 ton

**DB1012** Shackle - 4.7 ton

**DB1322** Swivel shackle

**DB1323** Non-forged jate ring

**DB1329** Forged jate ring

**DB1008** Pulley hook

SWL loads - Pulling - 1,500kgs / Lifting - 750kgs

**DB1002** Snatch block

High quality tempered steel  
Maximum head load - 9,000kgs

**ARB2091**  
**ARB Snatch Block 7000**

ARB's easy to use 7,000kg snatch block doubles the capacity of your winch and is suitable for a variety of off-roading uses. Engineered tough for serious recovery. Allows winching from awkward angles and incorporates a grease nipple to ensure smooth pulley operation. Suits mounted and portable vehicle winches.

Working Load	7,000kg
Breaking Strength	14,500kg
Side Plate Material	5mm cold rolled steel
Pulley Material	Solid billet steel
Pulley Diameter	93mm
Cable Size	6mm - 12mm
Weight	3.5kg
Greaseable	Yes



**DA8995**

**ARB Snatch Block 9000**

Feature side plates that sit snug against the pulley, eliminating the possibility of the winch cable becoming trapped between the pulley and the side plates. The groove on the pulley itself tapers down to the centre allowing for a variety of cable sizes (1/4"-1/2") to be used and ensures the cable is seated securely in the pulley, minimizing lateral movement.

**Features**

- > Works with steel or synthetic winch lines
- > Light weight design
- > Easy to use
- > Doubles the capacity of your winch
- > Allows winching from awkward angles
- > Engineered tough for serious recovery
- > Suits vehicle mounted and portable winches
- > Vehicle recovery booklet enclosed

**Specifications**

Working load:	9,000kg (20,000lbs)
Breaking strength:	17,500kg (38,500lbs)
Side plate material:	6mm cold rolled steel
Pulley material:	Specialized polymer
Pulley diameter:	110mm (4.3")
Cable size:	8mm - 13mm (0.3"-0.5")
Weight:	2.4kg (5.3lbs)
Greaseable:	Not required



**4X4 ACCESSORIES**

ARB products available in the UK only.



### Safety Equipment



- DA2037** Universal battery isolator switch
- DA2037KY** Replacement isolator switch key for DA2037
- DA3156** Winch In Safety - A5 guide from Land Rover
- DB1000** Wheel chocks - pair
- DB1016** Winch blanket

Manufactured from heavy-duty vinyl, the blanket will absorb most of the recoil in the unlikely event of the cable breaking. It's also very useful to kneel on in the mud!

- DB1308** 12 volt winch remote control
- Operate your winch from a safe distance with this wireless remote control
- > High frequency circuit using SMD design for reliability
- > The transmitter uses FM technology for frequency stability and greater control distance
- > Receiver output is protected against voltage spikes

**Gloves**  
When winching, gloves are essential safety wear to protect your hands from many of the hazards you may encounter.

- DB1010** Gloves - Britpart
- GLOVES** Gloves - ARB

**GLOVEMX** Recovery gloves - ARB  
Perfect for hand protection and keeping your hands clean during recovery situations, general work on your vehicle or around the campsite. Providing general protection in a stylish design, these gloves are a perfect addition to the glove box or recovery kit. Using premium synthetic materials to reduce abrasion and wear, as well as increase comfort on your hand, the ARB recovery gloves provide knuckle protection as well as palm protection with moulded rubber impact guards. The high abrasion resistant material on the inside palm of the glove works well with wire or synthetic rope winch cables. Added protection to the palm and fingers provide a safe yet good dexterity glove with a firm fitment, reducing pinching hazards. The cuff is embedded with the ARB Recovery logo and touch tape fastener to keep the glove firmly fitted. Finished in a breathable microfibre and ARB hi-viz recovery orange (which is great for marshalling or spotting operations), these gloves will complement your already excellent ARB recovery range.

## Winch with safety in mind



### Winching & Recovery Accessory Kits



Britpart Pulling Power winching recovery kits come with all the basic items needed to ensure your winch can be used to the best effect. There is a choice of a starter or professional kit depending on your needs.

- DB1015**
- 1 x DB1000 Wheel chocks (pair)
- 1 x DB1001 Winch kit bag
- 1 x DB1002 Snatch block - 9,000kgs
- 1 x DB1006 Tow strap - 8 ton, 60mm x 9m
- 1 x DB1007 Tree strop
- 1 x DB1010 Winching gloves
- 1 x DB1011 Snatch tow sling - 8 ton
- 2 x DB1012 Alloy bow shackle - 4.75 ton
- 1 x DB1016 Winching blanket
- DB1017**
- 1 x DB1001 Winch kit bag
- 1 x DB1002 Snatch block - 9,000kgs
- 1 x DB1006 Tow strap - 8 ton, 60mm x 9m
- 1 x DB1007 Tree strop
- 1 x DB1010 Winching gloves
- 2 x DB1012 Alloy bow shackle - 4.75 ton

- DB1017P**
- 1 x DB1001 Winch kit bag
- 1 x DB1002 Snatch block - 9,000kgs
- 1 x DB1007 Tree strop
- 1 x DB1010 Winching gloves
- 2 x DB1012 Alloy bow shackle - 4.75 ton
- 2 x DB1329 Jate rings



- RK12A**
- ARB Weekender Recovery Kit**
- > 8,000kg recovery strap
- > 4.75 ton Type "S" 19mm galvanized shackles x 2
- > Pair leather gloves

With an ARB recovery kit you have the peace of mind carrying a purpose-built recovery bag filled with a selection of items that will come in handy the next time you get stuck.

- RK9A NEW**
- ARB Premium Recovery Kit**
- 1 x 8,000kg snatch strap
- 1 x 12,000kg tree trunk protector
- 1 x 4,500kg winch extension strap
- 1 x 9,000kg competition snatch block
- 2 x 4.75 ton Type "S" galvanized shackles
- 1 x Recovery dampener
- 1 x pair of leather gloves

- DA8928**
- ARB Essentials Recovery Kit**
- > 8,000kg snatch strap
- > 12,000kg tree trunk protector
- > 9,000kg snatch block
- > Snatch pack storage bag
- > Bow shackles





**Other Essential Winching Accessories**

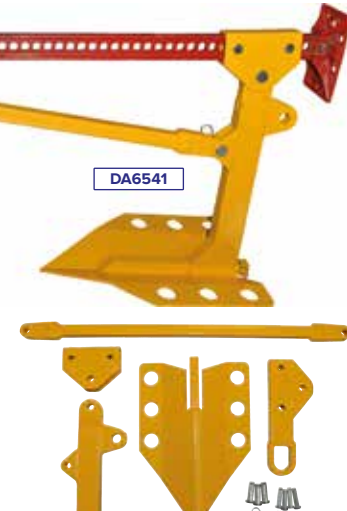

Contents not included

**DB1001** Britpart Winch Bag

A heavy-duty Britpart branded bag. Ideal for keeping dirty recovery gear in one place.

**ARB501A** ARB Large Recovery Bag

Designed to fit a complete recovery kit including snatch strap, tree trunk protector, winch extension strap, snatch block, recovery damper, bow shackles and gloves. **Note** - The winch pack is sold individually and does not come stocked with the straps. All items sold separately so the user can select the correct strap weights for their vehicle.

**ARB503A** ARB Compact Recovery Bag

Perfect for carrying a single strap and a pair of shackles. Small enough to fit under a seat or in the back of a drawer system, this recovery bag is a convenient way to keep your most important items in your rig at all times. More information online. **Note** - Bag only.

**ARB504A** ARB Micro Recovery Bag

Ideal for keeping smaller items such as a snatch block, drag chains, shackles and general recovery items from rolling around the back of your vehicle. This will keep them all neatly together in a highly visible bag, ready to use in any recovery situation you might come across, especially if it's an emergency. **Note** - Bag only.

**DB1014** Extended Winch Wiring Kit

1 x red (1.8m) & 1 x black (1.8m) wires with end connectors and isolator switch. Ideal for Defenders - up to 2007

**DB1035** Extended Winch Wiring Kit

2 x red (3.15m & 0.60m) & 1 x black (1.8m) wires with end connectors and isolator switch. Ideal for Defender - 2007 onwards.

**DA6541** Ground Anchor

Pull yourself out of trouble with this heavy-duty ground anchor. This anchor utilises a HI-Lift jack (not included).

**DB1314** Ground Anchor Set

600mm pins

**DB1318** Ground anchor Bag Set

2 x Pulling Power bags. **Note** - Ground anchor not included (DA1314)

**DB1357**

Replacement Dyneema® winch rope with competition hook & drum connector

Grey  
11mm x 30m  
CHOE+DC  
Breaking point - 10,773kg

**Construction**

- > Material - UHMPE (Ultra High modulus polyethylene)
- > Construction - 12-strand braided
- > Coating - 'Armourcoat' PU impregnation

**Properties**

- > Very high strength - Improved safety
- > Light weight - Easily handled
- > Low elongation - Low stored energy improves safety
- > Synthetic fibre - No wire splinters
- > 12-strand - Easily spliced
- > Armourcoated - Improves abrasion resistance and feel
- > Good UV resistance - Durable and suitable for long term outdoor use
- > Excellent chemical resistance - Resistant to most common chemicals



Photo by Harry Mitchell



**Oops!...**

*"Glad I've got that Britpart winch"*



### Optima Batteries



With its patented Spiralcell® Technology, Optima batteries offer 15 times the vibration resistance and up to twice the life of ordinary batteries. The Optima is like no other battery found in today's market. Optima's unique patented Spiralcell® design offers the best technology by providing a strong and clean power source that far surpasses any of today's traditional lead acid batteries. With Optima as your choice, you can count on a longer lasting battery.

#### Yellow Top

Demand more from your vehicle? Then get more from your battery. Optima Yellow Top batteries are made for the extremes. If your vehicle is designed to take the abuse of off-road driving, you need increased performance and reliability from your battery. Optima batteries combine patented Spiralcell® Technology to deliver that performance. The deep cycle

# OPTIMA® BATTERIES

characteristics of this technology coupled with its extreme resistance to vibration provides performance vehicles with the repetitive power they need, packaged in a spill-proof compact design. If your vehicle is fitted with high drain accessories such as additional lighting, tracking devices, ICE systems, winches, hydraulics etc, then this

ultimately demands more from your battery. Optima Yellow Top batteries provide the extra performance and deep cycling capability that your vehicle demands.

#### Red Top

Optima Red Top batteries are built to withstand the abuse 4x4's experience on and off-road. Spiralcell® Technology immobilises the internal components of the battery, enabling Optima batteries to withstand incredible amounts of vibration.

Vehicles modified for improved engine performance demand more from a battery. Optima batteries withstand the high engine bay temperatures associated with these performance vehicles. The sealed construction makes the battery spill-proof, even if you install it on its side! This prevents external gassing and leaking which can damage engine components and reduce battery performance. If your battery is used in applications that demand extra reliability endurance and performance, or if you just take pride in getting the best performance out of your vehicle, Optima Red Top batteries deliver the performance you demand.

#### Yellow Top Batteries

Voltage - 12v

Capacity - 55Ah

Cold Cranking Amps (CCA) - 765

**DB1018** Top terminals

**DB1020** Top & side terminals

#### Red Top Batteries

Voltage - 12v

Capacity - 50Ah

Cold Cranking Amps (CCA) - 815

**DB1019** Top terminals

**DB1021** Top & side terminals

### Battery Charger



- > Includes settings for both standard vehicles and Start/Stop
- > Includes battery repair tools to increase performance and battery life
- > Charging current up to 12A
- > Battery capacity: 25-300Ah
- > Interactive LCD display
- > Memory saver function allows vehicle and audio settings to be retained if the battery is removed
- > Product dimensions - 139 H x 197 W x 74mm D
- > Weight - 1.48kg
- > Voltage - 230V AC input & 12V DC output
- > Includes the following battery and alternator analysis tools:
  - Start power test - measures voltage drop during engine start to identify potential battery issues
  - Alternator check - tests the recharging performance of the vehicles alternator
  - Battery cranking performance - measures the battery's cold cranking performance to determine engine starting ability

*Keep your batteries  
in tip-top condition*

#### DA3185R

#### Multi-Stage Fully Automatic SmartCharger

From Ring - the ultimate in battery maintenance. Diagnose, repair, recondition and charge in one automatic device. Ideal for long-term connection and winter charging. This is battery care made easy. This charger is a multi-award winning SmartCharger. It has won the Automechanika Madrid Exhibition Award for Innovation, Auto Express' Product of the Year and Land Rover Monthly's Best Buy.

- > Multi stage fully automatic SmartCharger
- > Auto charge applies the fastest charge, based on battery size

### Replacement Batteries



- > Batteries are manufactured on the same equipment as OE batteries and use the same components to give consistent quality and performance
- > OE quality standards, giving assurance that the batteries will not let the user down
- > Batteries are recyclable, helping to protect the environment

	Capacity	CCA*
<b>LR047630</b>	15Ah	200
<b>STC4757</b>	70Ah	500
<b>YGD500100</b>	70Ah	640
<b>LR094611</b>	70Ah	760
<b>LR038128</b>	80Ah	770
<b>LR072855</b>	95Ah	855
<b>LR038341</b>	95Ah	855
<b>LR094642</b>	95Ah	855
<b>YGD100860</b>	100Ah	1000mCA
<b>STC8587</b>	110Ah	750
<b>YGD000271</b>	110Ah	920

\*Cold cranking amps

### Battery-Guard

#### DA1460

With the Battery-Guard and Apple or Android App, you can check your battery's state of charge quickly and easily. Because only with a fully charged vehicle battery can you be sure to avoid getting stuck. Compatible from iPhone 4S, Android 4.3 and Windows 10.

#### Features

- > Several vehicles can be monitored
- > Easy install to the battery
- > Monitoring of 6, 12 and 24 volt batteries possible
- > Power consumption is only about 6-24 mW
- > Reverse-polarity does not cause damage to the transmitter or battery
- > App compatible from iPhone 4S, Android 4.3 or Windows 10



*Battery monitoring  
via Bluetooth*

#### Operating Instructions

1. Download the Battery-Guard App  
Compatible from iPhone 4S, Android 4.3 & Windows 10.
2. Connect the Battery-Guard  
Attach the Battery-Guard to the battery terminals. Fix the transmitter to the cleaned battery using the adhesive film provided.
3. Activate Bluetooth  
Activate Bluetooth on your smartphone and then open the App. Bluetooth search mode is not required.
4. Functions  
The transmitter appears in the list display. You can assign a name, an image and the rated voltage to the transmitter.





**Dual Battery Management System**

**DA1174**

**Microprocessor Controlled  
Dual Battery Management System**

This fully automatic battery management system separates the starter battery from auxiliary battery if the vehicle has stopped and links them while the car is running. All systems are equipped with a 200A power relay. For emergency situations all systems are equipped with the manual override function. This manual linking function (called load sharing) is very helpful for jump starting or when using high current appliances such as an electrical recovery winch, power inverter or compressor. The kit includes a 4.7m wiring loom with sealed automotive plug, battery and crimp terminals for easy installation. The battery monitor is installed in the vehicle and informs the driver about the charge level of both batteries, the charging voltage from the alternator or an additionally installed solar system and the relay link status. The system offers low battery alarm on both batteries and a link failure alarm. Includes a manual link for 30 & 120 minutes with automatic return.

**Functions**

**Display of Battery Voltage (Energy Level)**

**LED Indicators**

- Green: Batteries are in the safe working range
- Yellow: Check batteries
- Red: Batteries should be charged

The LED's show the energy level if all loads are switched off: 12.6V = 100% / 12.4V = 75% / 12.2V = 50% / 12.0V = 25% 11.0V = flashing and beeping indicates low battery situation This function is called by pressing the display button for about 30 seconds.

**Display of Charge Voltage While Charging**

**LED Indicators**

- Red: >14.5V: High loading of batteries, may be present at cold ambient temperature for a longer time.
- Yellow: >14.0V: Proper charge mode.
- Green: <14.0V: Save charge mode, no damage to batteries.

**Bi-directional Automatic Battery Link**

While the engine is running the main and auxiliary batteries are linked together for parallel charging from the alternator (green LED linked is on). If the engine is stopped, the two batteries will be disconnected automatically with some delay. Appliances such as fridges, lights, compressors, inverters are now safely fed from the auxiliary battery. With the additional charge by solar equipment, battery charger or generator is sufficient for charging, the starter battery will be charged automatically with auxiliary battery together (green LED "link" lights).

**Manual Battery "Link"**

In an emergency situation (defective or empty main battery) or in case of higher power consumption the two batteries (main & auxiliary) may be connected together by activating the link button (red LED manually linked is on). After a lapse of time of 30 minutes (or immediately after activating the auto button), the system returns to the automatic mode. When using an electric winch, the battery connection can be activated for 120 minutes by pressing the link button twice. In this mode sounds a beep every 30 seconds to remind of this status (auto return after time expired). The load sharing function with the manual battery connection reduces the load on the alternator, the wiring and the batteries in the use of the winch.

**Alarm Functions:**

**Low Battery Alarm**

If the battery voltage of one or both of the batteries, is for a longer period below 12V, the sound low battery with "Beep" and the LED "Low Battery" of the corresponding battery (main and/or auxiliary) flashes. With the display button, the "Beep" is switched off. The blinking LED "Low Battery" is reset if the battery voltage is exceeding 12V.

**Link Failure Alarm**

The monitor monitors the charge on both batteries. When fitting charge (from alternator, solar, charger) no charge to the other battery is detected, the link error alarm with flashing green LED "linked" and the "Beep" sounds. If this error occurs, check immediately the wiring of the power cables to (relay, battery terminals, crimp contacts, control relays). After bug fixes, alarm will automatically reset.

**Deactivation of Automatic & Manual Battery Dual Link Function**

If there a problem with the auxiliary battery (aux) as short circuit of cells, short circuit or defective battery housing, leading to damage of the generator (alternator). In an emergency situation the battery system can be operated in the vehicle in the basic configuration (alternator, starter battery without additional charge to auxiliary battery). By pressing the link button for 6 seconds (until the sound of the beep), the link is deactivated. In this mode, no manual and automatic battery connection is possible. This feature can solve the battery problem of the auxiliary battery by pressing the auto button for 6 seconds to be reset. Now the system is working again with all the functions.

**Specifications**

- Supply voltage 4 - 16V
- System voltage 12V
- Measuring range (sense wire blue) 8 - 16V
- Display range (battery voltage) 11.0V - 12.8V
- Alarm level main and aux 12.0V
- Display range (charge) 13.0V - 14.5V
- Accuracy +/-1%
- Consumption monitor 1mA
- Consumption max. display active (30 sec) 20mA
- Isolator link-on/off threshold 13.1V/13.0V
- Consumption on-state (relay) 0.6A
- Relay continuous load current 200A
- Relay current inrush 500A
- Relay contact material Silver (AG SnO2)
- Free combination of batteries possible? Yes
- Operating temperature -40°C - +80°C
- Housing ABS black
- Sealing level IP40
- Size, dimensions 100 x 65 x 24mm
- Weight 800g

- Cabling Red - Supply/sense (main battery)
- Black - GND (main battery)
- Blue - Sense (aux battery)
- Green - Control relay (open collector)

**Protected against**

Wrong polarity & against overload of solenoid driving circuit on PC board with SMD electronically security devices, no fuses have to be replaced.

**Winch Application**

Connect an electrical recovery winch to the main battery as shown in the wiring diagram.

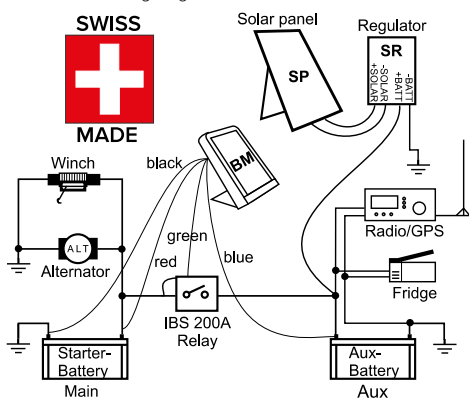

DA1174



**Mounting Options**

- DA1174GM Mounting plate with flexible arm
- DA1174SM Mounting plate with swivel mount
- DA1174HM Mounting plate with swivel arm



**Comfort Connectors**

**DA1410**



**DA1409**

7-pin charging adaptor

**DA1410**

13-pin charging adaptor

Custom adaptors, using genuine CTEK comfort connect adaptors allows a vehicle's battery to be charged through the caravan towing electric socket. The vehicle must have fully populated towing electrics for these adaptors to work. For use with CTEK Multi-XS7000 universal battery charger.

**Split Charge Relay**

**DB1500**

Heavy-duty  
200A split charger



**Alternator Upgrade Kits**



**DA7195**

- 200Tdi alternator upgrade kits. Kits include uprated cable.
- DA1195 Defender - 200Tdi Upgrade 45A to 100A
- DA7195 NEW Defender - 200Tdi Upgrade 45A to 70A
- DA1196 Discovery 1 - 200Tdi Upgrade to 100A



### Tamper Proof Nuts & Bolts



DA7333

DA7332

Ensure your precious accessories remain firmly on your Land Rover by using a set of these stainless steel tamper proof nuts and bolts. Ideal for securing your winch and front bumper. Each set contains either 4 nuts or bolts and 1 key.

DA7330 M6 nut set & key

DA7331 M8 nut set & key

DA7332 M10 nut set & key

DA7333 M10 x 110 bolt set & key

DA7334 M10 x 35 bolt set & key

### Number Plate Bracket



DA5699

Universal number plate mounting bracket  
405 W x 110mm D



Number plate not included





# PERFORMANCE

Upgrade From  
The Ordinary





### Britpart Performance Brake Discs

Corresponds to					Corresponds to				
<b>Defender 1987 - 2006 &amp; 2007 onwards</b>					<b>Range Rover Classic</b>				
<b>DA4600</b>	LR017951/FRC7329		Front	Solid	<b>DA4600</b>	LR017951/FRC7329	1986 - 1991	Front	Solid
<b>DA4602</b>	LR017952/FTC902		Front	Vented	<b>DA4602</b>	LR017952/FTC902	1986 - 1994	Front	Vented
<b>DA4601</b>	LR017953/FTC1381		Rear	Solid	<b>DA4601</b>	LR017953/FTC1381	1986 - 1994	Rear	Solid
<b>DA4605</b>	LR018026/SDB000330		Rear	Solid					
<b>Discovery 1</b>					<b>Range Rover P38</b>				
<b>DA4600</b>	LR017951/FRC7329		Front	Solid	<b>DA4603</b>	NTC8780	1995 - 2002	Front	Vented
<b>DA4602</b>	LR017952/FTC902		Front	Vented	<b>DA4604</b>	SDB000470	1995 - 2002	Rear	Solid
<b>DA4601</b>	LR017953/FTC1381		Rear	Solid					
<b>Discovery 2</b>					<b>Range Rover Sport</b>				
<b>DA4606</b>	SDB000380		Front	Vented	<b>DA4611</b>	SDB000614	2005 - 2009	Front	Vented
<b>DA4604</b>	SDB000470		Rear	Solid	<b>DA4612</b>	SDB000604	2005 - 2009	Front	Vented
					<b>DA4624</b>	SDB000624	2005 - 2013	Front	Vented
<b>Discovery 3</b>					<b>Range Rover Sport</b>				
<b>DA4611</b>	SDB000614		Front	Vented	<b>DA4613</b>	SDB000646	2005 - 2013	Rear	Vented
<b>DA4612</b>	SDB000604		Front	Vented	<b>DA4614</b>	SDB000636	2005 - 2009	Rear	Vented
<b>DA4613</b>	SDB000646		Rear	Vented	<b>DA4628</b>	LR016192	2010 - 2013	Rear	Vented
<b>DA4614</b>	SDB000636		Rear	Vented	<b>DA4627</b>	LR016176	2014 onwards	Front	Vented
<b>Discovery 4</b>					<b>Range Rover L322</b>				
<b>DA4612</b>	SDB000604		Front	Vented	<b>DA4609</b>	SDB000201		Front	Vented
<b>DA4624</b>	SDB000624		Front	Vented	<b>DA4619</b>	SDB500182		Front	Vented
<b>DA4613</b>	SDB000646		Rear	Vented	<b>DA4622</b>	LR031843/SDB500193		Front	Vented
<b>DA4614</b>	SDB000636		Rear	Vented	<b>DA4610</b>	SDB000211		Rear	Solid
<b>Discovery Sport</b>					<b>Range Rover L405</b>				
<b>DA4689</b>	LR059122		Front	Vented	<b>DA4627</b>	LR017804/LR031844/SDB500202/SDB500201		Rear	Vented
<b>DA4690</b>	LR061388		Rear	Solid	<b>DA4625</b>	LR011591	2010 - 2012	Front	Vented
					<b>DA4627</b>	LR016176	2010 - 2012	Front	Vented
<b>Freelander 1</b>					<b>Range Rover L405</b>				
<b>DA4607</b>	SDB100830	Up to YA999999	Front	Solid	<b>DA4626</b>	LR011891/LR031846	2010 - 2012	Rear	Vented
<b>DA4608</b>	SDB101070	1A000001 onwards	Front	Vented					
<b>Freelander 2</b>					<b>Range Rover Evoque</b>				
<b>DA4617</b>	LR000470/LR027107	Petrol	Front	Vented	<b>DA4618</b>	LR007055		Front	Vented
<b>DA4615</b>	LR001019	Petrol	Rear	Vented	<b>DA4689</b>	LR059122	17"	Front	Vented
<b>DA4618</b>	LR007055	Diesel	Front	Vented	<b>DA4683</b>	LR027123		Rear	Solid
<b>DA4616</b>	LR001018	Diesel	Rear	Solid					
<b>DA4688</b>	LR039935		Rear	Solid					

## Quality performance brake discs

- > Slotted design to increase braking efficiency by reducing dust, debris, water & gas on the disc
- > To improve brake cooling, reduce weight and to offer an escape route for dirt & gasses these performance discs are drilled with rows of holes
- > Excellent upgrade for your Land Rover to aid braking, especially under a heavy load
- > Ideal for off-road use
- > Manufactured to British Standard BS1452 Grade 220 and DIN1691 GG20
- > Supplied in pairs



#### IMPORTANT BRAKE INFORMATION

For exact change over points with vehicle applications please contact your local Britpart stockist with the full chassis number for the correct application. These references are intended as a guide only.



Alcon Brake Kits



DA2700



DA2703



DA2704

**Defender 18" Wheel Front Brake Kits**

- > Fixed iron 'C' groove disc assembly - Ø355 x 32mm
- > 6 Piston monoblock cast caliper
- > Performance brake pads included

DA2700	18" 6 Piston kit	Red
DA2701	18" 6 Piston kit	Silver

**Replacement Parts**

DA2709	18" Front left brake disc
DA2710	18" Front right brake disc
DA2711	18" Front brake pad set
DA2797 NEW	18" Front anti-rattle clip

**Alcon Defender Brake Kits**

- > High friction brake pads increase stopping power
- > Increased brake pad area reduces temperatures and increases pad life
- > Staggered position in order to ensure even brake pad wear
- > Stainless steel pistons as standard for improved resistance to thermal conductivity
- > Hard wearing anodised alloy caliper
- > Internally drilled, no external pipes

**Defender 16" Wheel Front Brake Kits**

- > Fixed iron 'C' groove disc assembly - Ø334 x 28mm
- > 4 Piston 2 piece cast caliper
- > Performance brake pads included

> TÜV approval certification is available when fitting the 16" brake kits to a Defender - DA2702 plus DA2704 and DA2703 plus DA2705

DA2702	16" 4 Piston kit	Red
DA2703	16" 4 Piston kit	Silver

**Replacement Parts**

DA2706	16" Front left brake disc
DA2707	16" Front right brake disc
DA2708	16" Front brake pad set
DA3335 NEW	16" Front anti-rattle clip

**Defender Rear Brake Kits**

- > Solid 'C' groove disc - Ø298 x 14mm
- > 4 Piston forged caliper
- > Performance brake pads included

DA2704	4 Piston kit	Red
DA2705	4 Piston kit	Silver

**Replacement Parts**

DA2712	Rear left brake disc
DA2713	Rear right brake disc
DA2714	Rear brake pad set
DA3339 NEW	Rear anti-rattle clip

**Note** - Both DA2704 & DA2705 rear kits are suitable for fitment on Defenders where either 16" or 18" front disc kits are fitted. For Defender 110 the rear kit will only fit vehicles from VA128340.

*When you're heading into extreme terrain, you leave nothing to chance. That's why you've probably already added some aftermarket upgrades - suspension lift kit, bigger tyres & a winch etc. But there's one problem; the weight of all that extra gear can put a strain on your Defender's braking performance. The more serious your adventure, the more you need an Alcon uprated brake kit.*

*The Alcon complete uprated brake solutions are designed to perform superbly even in the harshest conditions. From high rocks to desert washes, these extensively tested brake systems will battle through the toughest challenges without sacrificing performance.*



Alcon is a global leader in the design, development and manufacture of brakes, clutches & actuation for motorsport, OEM, aftermarket, specialist and armoured/military vehicles. Alcon's range of brakes, clutches & actuation is huge. It has been developed for over 30 years by working at the top level of motorsport including F1, NASCAR, GT racing, World Rally, and Touring Cars to name but a few. With a wealth of experience in brake and clutch design, backed up by our well-equipped development facility based within "Motorsport Valley" in the UK, Alcon thrives on the challenge of devising innovative and unusual solutions for every application. We use our specialist knowledge to create the best solutions for every customer's need. That's why we're the best at what we do.

*Extensively tested brake systems will battle through the toughest challenges without sacrificing performance.*



DA2700



Photo by Ming Lee



### EBC Brake Discs

Defender	Corresponds to			
<b>DA4165</b>	LR017951/FRC7329	Defender - 1987 - 2006 & 2007 onwards	Front	Solid
<b>DA4151</b>	LR017952/FTC902	Defender - 1987 - 2006 & 2007 onwards	Front	Vented
<b>DA4152</b>	LR017953/FTC1381	Defender - 1987 - 2006 & 2007 onwards	Rear	Solid
<b>DA4855</b>	SDB000330	Defender - 1987 - 2006 & 2007 onwards	Rear	Solid
<b>Discovery</b>				
<b>DA4165</b>	LR017951/FRC7329	Discovery 1	Front	Solid
<b>DA4151</b>	LR017952/FTC902	Discovery 1	Front	Vented
<b>DA4152</b>	LR017953/FTC1381	Discovery 1	Rear	Solid
<b>DA4158</b>	SDB000380	Discovery 2	Front	Vented
<b>DA4148</b>	SDB000470	Discovery 2	Rear	Solid
<b>DA4187</b>	SDB000614	Discovery 3	Front	Vented
<b>DA4475</b>	SDB000604	Discovery 3	Front	Vented
<b>DA4188</b>	SDB000646	Discovery 3	Rear	Vented
<b>DA4473</b>	SDB000636	Discovery 3	Rear	Vented
<b>DA4496</b>	SDB000624	Discovery 4	Front	Vented
<b>DA4475</b>	SDB000604	Discovery 4	Front	Vented
<b>DA4188</b>	SDB000646	Discovery 4	Rear	Vented
<b>DA4473</b>	SDB000636	Discovery 4	Rear	Vented
<b>Freelander</b>				
<b>DA4477</b>	SDB101070	Freelander 1 - 1996 from 1A000001	Front	Vented
<b>DA4551</b>	LR000470/LR027107	Freelander 2 - petrol	Front	Vented
<b>DA4549</b>	LR001019	Freelander 2 - petrol	Rear	Vented
<b>DA4552</b>	LR007055	Freelander 2 - diesel	Front	Vented
<b>DA4550</b>	LR001018	Freelander 2 - diesel	Rear	Solid
<b>Range Rover</b>				
<b>DA4165</b>	LR017951/FRC7329	Range Rover Classic - 1986 - 1991	Front	Solid
<b>DA4151</b>	LR017952/FTC902	Range Rover Classic - 1986 - 1994	Front	Vented
<b>DA4152</b>	LR017953/FTC1381	Range Rover Classic - 1986 - 1994	Rear	Solid
<b>DA4147</b>	NTC8780	Range Rover P38 - 1995 - 2002	Front	Vented
<b>DA4148</b>	SDB000470	Range Rover P38 - 1995 - 2002	Rear	Solid
<b>DA4187</b>	SDB000614	Range Rover Sport - 2005 - 2009	Front	Vented
<b>DA4475</b>	SDB000604	Range Rover Sport - 2005 - 2009	Front	Vented
<b>DA4496</b>	SDB000624	Range Rover Sport - 2005 - 2009 & 2010 - 2013	Front	Vented
<b>DA4188</b>	SDB000646	Range Rover Sport - 2005 - 2013	Rear	Vented
<b>DA4473</b>	SDB000636	Range Rover Sport - 2005 - 2009	Rear	Vented
<b>DA4474</b>	SDB000201	Range Rover L322	Front	Vented
<b>DA4476</b>	SDB500193	Range Rover L322	Front	Vented
<b>DA4856</b>	SDB500182	Range Rover L322	Front	Vented
<b>DA4472</b>	SDB000211	Range Rover L322	Rear	Solid
<b>DA4488</b>	LR017804/LR031844	Range Rover L322	Rear	Vented
	SDB500202/SDB500201	<b>Note</b> - not dimpled or slotted		
<b>DA4552</b>	LR007055	Range Rover Evoque	Front	Vented
<b>DA4554</b>	LR027123	Range Rover Evoque	Rear	Solid



# EBC BRAKES

- > Sold in pairs
- > 100% British cast and machined high quality product
- > Wide aperture slots that draw cool air under the pad surface
- > Slots that expel all dirt dust and debris from the braking area
- > Blind drilled dimples that eliminate cracking common with through drilled sport rotors whilst helping maintain perfect pad contact

#### IMPORTANT BRAKE INFORMATION

For exact change over points with vehicle applications please contact your local Britpart stockist with the full chassis number for the correct application. These references are intended as a guide only.

### Anti-squeal Shims



#### DA1141

Universal self adhesive noise dampening shims. Pack of 4. The shims are manufactured from wolverine and cut to shape and applied to the backing plate of the brake pads prior to fitting to help eliminate any noise issues (should the pad be unshimmed). When used in conjunction with Mintex Cera-Tec silicon based lubricant, most brake noise related issues will be eradicated.

### Brake Pads - DTEC

#### High Performance, Low Dust

DTEC is an advanced, low dust, ceramic formulation which has been developed by TRW for those customers who want cleaner wheels without compromising the braking performance that they are used to.

The new material meets all EU legislative requirements as well as TRW's demanding performance requirements.

In addition, rim surface dust levels have been reduced by up to 45% when compared to other standard materials. Cotec coating improves green behaviour during bedding in and ensures great pedal feel from the first stop.

#### Discovery 3

**LR134694DT**

Front

**LR134696DT**

Rear

#### Discovery 4

**LR134694DT**

Front

**LR134700DT**

Front

**LR134696DT**

Rear

**LR139969DT**

Rear

#### Discovery 5

**LR134700DT**

Front



#### Range Rover L322

**LR148353DT NEW**

2002 - 2009

Front

**LR134694DT**

2002 - 2009

Front

**LR026221DT**

2010 - 2012

Front

**LR134696DT**

2002 - 2009

Rear

**LR139969DT**

2010 - 2012

Rear

#### Range Rover L405

**LR134700DT**

Front

#### Freelander 2

**LR134692DT**

Front

**LR134695DT**

Rear

#### Range Rover Sport

**LR148353DT NEW**

2002 - 2009

Front

**LR134694DT**

2005 - 2009

Front

**LR134700DT**

2010 - 2013 & 2014 -

Front

**LR134696DT**

2005 - 2009

Rear

**LR139969DT**

2010 - 2013

Rear

### Brake Lubrication



#### DA2389 Cera-Tec Advanced Lubricant

75ml  
Mintex Cera-Tec is an advanced non-metallic universal lubricant that provides many benefits over traditional copper-based grease. More details available in the Repair & Service section.



Dust levels reduced  
by up to 45%

Developed for customers who want cleaner wheels without compromising the braking performance that they are used to





Brake Pads - EBC



			Cross Reference 1	Cross Reference 2	Cross Reference 3	
<b>Defender</b>						
DA3311*	DA4157	DA4842	Defender 90 - 1986 - 1991	SFP500160	STC9191	Front
DA3310*	DA4159	DA4560	Defender 90 - from 1991	SFP000260	STC2952	Front
DA3318	DA4485	DA4849	Defender 90 - from 1994	SFP000270		Rear
DA3319*	DA4154	DA4850	Defender 90 - from 1994	SFP500200	STC9189	Rear
DA3307	DA4153		Defender 90 - up to 1986	SFP500220	STC9187	STC9186
DA3310*	DA4159	DA4560	Defender 110 - from 1986	SFP000260	STC2952	Front
DA3313*	DA4185	DA4695	Defender 110 - from 1994	SFP000280	SFP000160	STC1601
DA3308*			Defender 110 - up to 1986	STC2950		Front
<b>Discovery</b>						
DA3312*	DA4156	DA4842	Discovery 1	SFP500180	STC9190	Front
DA3311*	DA4157	DA4842	Discovery 1 - from 1994	SFP500160	STC9191	Front
DA3309*	DA4153		Discovery 1 - up to 1993	SFP500220	STC9187	Front
DA3319*	DA4154	DA4850	Discovery 1 - with sensor	SFP500200	STC9189	Rear
DA3318	DA4485	DA4849	Discovery 1 - without sensor	SFP000270		Rear
DA3300	DA4149	DA4336	Discovery 2	SFP500150	SFP000210	Front
DA3314	DA4150	DA4339	Discovery 2	SFP500130	SFP100470	Rear
DA3304	DA4481	DA4335	Discovery 3	LR019618	SFP500010	Front
DA3316	DA4484	DA4340	Discovery 3	LR019627	LR021316	SFP500140
DA3304	DA4481	DA4335	Discovery 4	LR019618	SFP500010	Front
DA4830	DA4837	DA4843	Discovery 4	LR021253	LR026221	Front
DA4831	DA4838	DA4844	Discovery 4	LR051626		Front
DA3316	DA4484	DA4340	Discovery 4	LR019627	LR021316	SFP500140
DA4900	DA4901	DA4902	Discovery Sport	LR072681		Front
DA4903	DA4904	DA4905	Discovery Sport	LR061385		Rear
<b>Freelander</b>						
DA3301	DA4478	DA4845	Freelander 1 - 1996 - from 1A000001	LR021899	SFP500100	Front
DA3302	DA4479		Freelander 1 - 1996 - up to YA999999	SFP100360		Front
DA3306	DA4486	DA4846	Freelander 2	LR004936		Front
	DA4839		Freelander 2	LR027309		Front
DA3317	DA4487	DA4851	Freelander 2	LR003657	LR023888	Rear
<b>Range Rover</b>						
DA3309*			Range Rover Classic - 1986 - 1991	SFP500220	STC9187	Front
DA3312*	DA4156	DA4842	Range Rover Classic - 1986 - 1996 - with sensor	SFP500180	STC9190	Front
DA3319*	DA4155	DA4850	Range Rover Classic - from 1986	SFP500200		Rear
DA3318	DA4485	DA4849	Range Rover Classic - up to 1985	SFP000270		Rear
DA3319*	DA4154	DA4850	Range Rover Classic - up to 1985	SFP500200	STC9189	Rear
DA3307	DA4153		Range Rover Classic - up to 1986	SFP500220	STC9187	STC9186
DA3300	DA4149	DA4336	Range Rover P38 - 1995 - 2002	SFP500120	SFP100460	Front
DA3314	DA4150	DA4339	Range Rover P38 - 1995 - 2002	SFP500130	SFP100470	Rear
DA3304	DA4481	DA4335	Range Rover Sport - 2005 - 2009	LR019618	SFP500010	Front
DA3305	DA4482	DA4337	Range Rover Sport - 2005 - 2009	SFP500070		Front
DA3316	DA4484	DA4340	Range Rover Sport - 2005 - 2013	LR019627	LR021316	SFP500140
DA4830	DA4837	DA4843	Range Rover Sport - 2010 - 2013	LR021253	LR026221	Front
DA4831	DA4838	DA4844	Range Rover Sport - 2010 - 2013	LR051626		Front
DA4833	DA4739	DA4847	Range Rover Sport - 2010 - 2013	LR064181	LR020362	Front
DA4835	DA4740	DA4853	Range Rover Sport - 2010 - 2013	LR025739		Rear
DA4831	DA4838	DA4844	Range Rover Sport - 2014 onwards	LR051626		Front
DA4833	DA4739	DA4847	Range Rover Sport - 2014 onwards	LR064181	LR020362	Front
DA4834	DA4840	DA4852	Range Rover Sport - 2014 onwards	LR036574	LR065492	LR068303
DA3303	DA4480	DA4338	Range Rover L322	SFC500080	SFC500050	Front
DA3304	DA4481	DA4335	Range Rover L322	LR019618	SFP500010	Front
DA3315	DA4483	DA4341	Range Rover L322	SFP500210	SFP000120	Rear
DA3316	DA4484	DA4340	Range Rover L322	LR019627	LR021316	SFP500140
DA3305	DA4482	DA4337	Range Rover L322 - 2002 - 2009	SFP500070		Front
DA4830	DA4837	DA4843	Range Rover L322 - 2010 - 2012	LR021253	LR026221	Front
DA4833	DA4739	DA4847	Range Rover L322 - 2010 - 2012	LR064181	LR020362	Front
DA4835	DA4740	DA4853	Range Rover L322 - 2010 - 2012	LR025739		Rear
DA4831	DA4838	DA4844	Range Rover L405	LR051626		Front
DA4833	DA4739	DA4847	Range Rover L405	LR064181	LR020362	Front
DA4834	DA4840	DA4852	Range Rover L405	LR036574	LR065492	LR068303
DA4900	DA4901	DA4902	Range Rover Evoque	LR072681		Front
DA3306	DA4839	DA4846	Range Rover Evoque - 2012 - 2015	LR027309		Front
DA4900	DA4901	DA4902	Range Rover Evoque - 2015 onwards	LR072681		Front
DA4836	DA4841	DA4854	Range Rover Evoque - 2012 - 2015	LR043714		Rear
DA4903	DA4904	DA4905	Range Rover Evoque - 2015 onwards	LR061385		Rear
DA4900	DA4901	DA4902	Range Rover Velar	LR072681		Front
DA4906	DA4907	DA4908	Range Rover Velar	LR064687		Front
DA4903	DA4904	DA4905	Range Rover Velar	LR061385		Rear

**EBC Ultimax Heavy-duty**

- > New AF42/66 friction material which completely eliminates brake judder and produces a high friction long lasting brake pad.
- > Unique powder coat finish to both pad and back plate gives lifetime resistance to corrosion and prevents moisture ingress.
- > Unique Brake-In surface coating provides instant brake efficiency on installation and conditions the brake rotor removing glaze, black spotting etc from disc surface.
- > All pads feature centre line slot which prevents heat expansion cracks and reduces brake noise.
- > All pads feature edge chamfers which have major technical benefits;
  - Significant reduction in brake noise
  - Prevents 'edge lifting' under left and right extremities of pad which can cause corrosion ingress and eventual pad de-bond
  - Can extend pad life by virtue of improved pad efficiency
- > Most pads in the Ultimax range features factory fitted noise reduction shims.

**EBC Green Stuff High Performance**

- > 100% British design and manufacture.
- > Superb gloss powder coat paint finish to reduce corrosion.
- > Unique engineering finish with noise reduction slots and edge chamfers.
- > Extra high friction compounds for better stops, these pads will improve your stopping power by up to three vehicle lengths.
- > Special compound ingredients that prevent "Outline Etching" eliminating brake stiction onto the rotor in damp conditions.
- > Unique "Brake-In" surface coating to accelerate pad bed in after installing new pads which also guarantees brake efficiency from installation.
- > Super quiet braking with rubber-steel-rubber noise reduction shims on the reverse, this dampens all possible noise.
- > Extra heavy duty compound lasts longer than low cost standard pads.
- > Fully ECE R 90 approved and legal for road and off road use.

**EBC Yellow Stuff Performance Race**

- > High friction compound which is effective from cold up to high heat.
- > Effective brake upgrade for heavy-duty braking.
- > Long lasting powerful brakes.
- > Shims, edge chamfers and slots for silent braking.

EBC Yellowstuff brake pads are British made and contain Aramid fibres. These are man-made high performance fibres, used widely for their light-weight, high strength, abrasion resistance and thermal stability. These properties provide advantages over cheaper steel fibre based products. Not only high in friction from first application when brakes are cold but extremely effective at higher brake temperatures as encountered in faster driving and towing/trailing. These pads are a favourite with the military and are used on armoured vehicles in several countries to handle the higher loads and heat and offer a good brake upgrade. Fitted with shims chamfers, centre slots and the unique EBC Brake in coating for fast bedding in of new brakes these pads are also long lasting and silent in operation.

**IMPORTANT BRAKE INFORMATION**

For exact change over points with vehicle applications please contact your local Britpart stockist with the full chassis number for the correct application. These references are intended as a guide only.

\*Pad sets exclude shims





### Britpart Stainless Steel Brake Line Kits

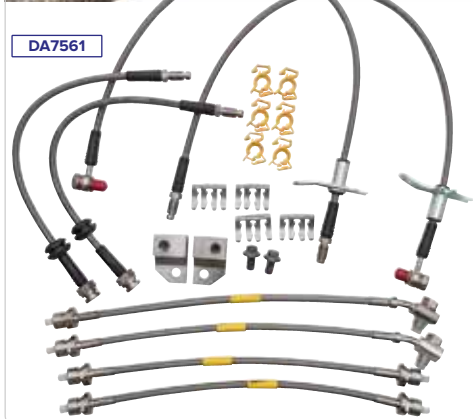

Britpart Brake Hose Kits	Standard	Plus 40mm	Plus 150mm
<b>Series 2/Series 3</b>			
SWB - 1960 - 1979 - imperial	DA2418S	DA241840S	
SWB - 1980 - 1984 - metric	DA2419S	DA241940S	
LWB - 1971 - 1979 approx - imperial	DA2420S*	DA242040S	
LWB - 1980 - 1984 - metric	DA2421S	DA242140S	
<b>Defender</b>			
90 - 1984 - 1998 (WA159806)	DA2400S	DA240040S	DA2400150S
110 - 1983 - 1998 (WA159806)	DA2402S	DA240240S	DA2402150S
90/110 - metric - 1999 (XA159807) - 2004 (4A683087) Non-ABS	DA2401S	DA240140S	DA2401150S
From 4A683088	DA3401S	DA340140S	
<b>Discovery 1</b>			
1989 - 1992 (JA034313)	DA2410S	DA241040S	DA2410150S
1992 (KA034314) - 1995 (LA081991)	DA2411S	DA241140S	DA2411150S
1995 (from MA018992) - 1999 - Non-ABS	DA2412S	DA241240S	DA2412150S
1995 (from MA018992) - 1999 - ABS	DA2413S	DA241340S	DA2413150S
<b>Discovery 2 - ABS</b>	DA2414S	DA241440S	DA2414150S
<b>Discovery 3</b>	DA7561		
<b>Discovery 4</b>	DA7561		
<b>Range Rover Classic</b>			
Up to 1981 - imperial - Non-ABS		DA240340S	
1981 - 1990 - metric - Non-ABS		DA240440S	
1990 - 1992 - metric - ABS		DA240640S	
1992 - metric - ABS		DA240740S	
<b>Range Rover P38</b>			
1995 - up to TA	DA2409S	DA240940S	
<b>Range Rover Sport - Mk1</b>	DA7561		

\*Note - Front hoses fit directly into the wheel cylinders replacing brake pipe 537763

These brakelines are constructed from the finest quality hose, consisting of a PTFE inner and stainless steel overbraid.

- > Eliminates sponginess under heavy braking
- > Increases braking efficiency
- > Abrasion and corrosion resistant
- > Britpart hoses available at plus 150mm lengths - ideal for use with our Plus 5" suspension products

**Note** - Brake hose clips - EJP7813 - are not included in any of the kits apart from DA7561.



*Increase your braking efficiency*

### Goodridge Premium Performance Brake Line Kits

- DA2930 Defender - 90/110/130 - 1999 - 2004 with ABS
- DA2672 Discovery 3
- DA2673 Discovery 4
- DA2677 Range Rover Sport - Mk1
- DA2674 Range Rover L322

Goodridge race-bred brake lines are constructed from the finest quality hose, consisting of a PTFE inner and stainless steel over braid.

- > 100% pressure tested
- > Greater braking efficiency
- > Resistance to abrasion and corrosion
- > Eliminates sponginess under heavy braking
- > Added reliability, safety & brilliant looks
- > Technically superior and race proven
- > FMVSS 106 Compliant, DOT, TÜV, ADR, ISO9001 Accredited



DA2421

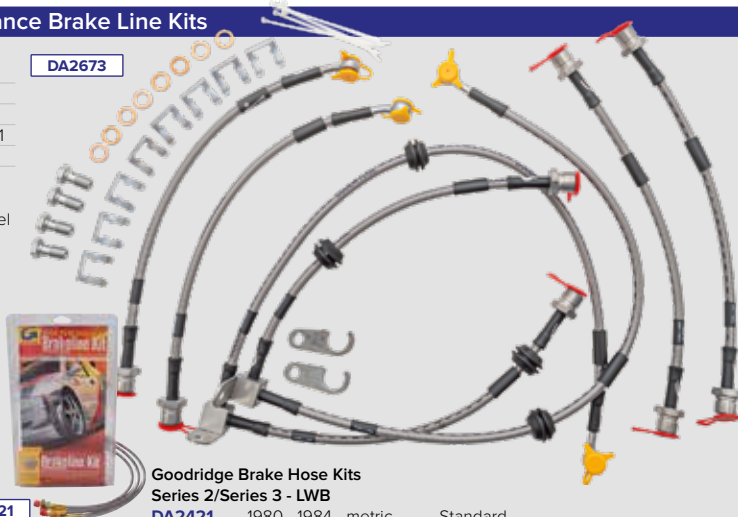

**Goodridge Brake Hose Kits**  
Series 2/Series 3 - LWB  
DA2421 1980 - 1984 - metric Standard



Photo by Enzo Garcia



Handbrake Conversion Kits

**Defender/Discovery/Range Rover Classic**

The disc transmission brake uses a state of the art monster sized mechanical caliper designed for agricultural vehicles and earth moving equipment - so using it on a Land Rover is easy work for it. The mechanism is sealed so it will not seize up due to ingress of mud or water and it uses special 'sintered' pads which are resistant to abrasion from mud as well as providing greater friction against the disc than a standard pad. The disc has been specially designed for Land Rovers and manufactured from tough 10mm thick steel. It has a smaller diameter than a standard drum and so does not dangle below the transfer box which helps to protect it from whatever you are driving over. The caliper mechanism sits in a well protected area at the top, away from most of the mud and water.

**DA5513**

Defender 90 & 110

For anything post 1993 (300Tdi, Td5 & Puma) you need to change the cable - NRC5088. Puma onwards - modifications may be needed to the chassis to enable fitment.

**DA5526**

Discovery 1/Discovery 2/Range Rover Classic  
Will not fit a Borg Warner or LT95 transfer box.

**XDISC**

Replacement disc

for DA5513

& DA5526

**XPAD**

Replacement pads

for DA5513

& DA5526

**Beef Up Your Land Rover's Handbrake!**

**Series**

**DA5537**

Series 1, 2 & 3

This will fit any Land Rover fitted with a standard Series transfer box, including those fitted with PTO's, under or overdrive units. The new brake replaces the original transmission brake drum. It is supplied with a new adjustable actuator rod which connects from your original handbrake lever, direct to the caliper, reducing the amount of slack in the linkages. The disc transmission brake uses an industrial open-frame caliper with simple adjustment and easy cleaning. The new caliper is mounted on a laser cut steel back-plate with a folded gusset for added strength and incorporating a built in skid plate to protect the disc which is manufactured from robust 10mm thick mild steel plate and which bolts directly to your original gearbox output flange with six new bolts (supplied). The system is very light weight, offering a saving of almost 10kg compared to an original drum brake.

**XPADSERIES**

Replacement brake pads for handbrake conversion kit - DA5537

*Driving off-road you'll know how easy it is for the standard Land Rover hand brake to get bunged up with dirt and once the mechanism gets clogged up it doesn't work as efficiently as it should. Britpart now offer a solution to that problem - a drum to disc conversion kit. These kits use powerful calipers whose mechanism is sealed to prevent the access of mud. Parts are supplied coated with a tough corrosion resistant coating of gold zinc passivate to ensure a long life. Fitting is easy requiring only simple tools. Full fitting instructions are included as well as advice on adjustment and use.*

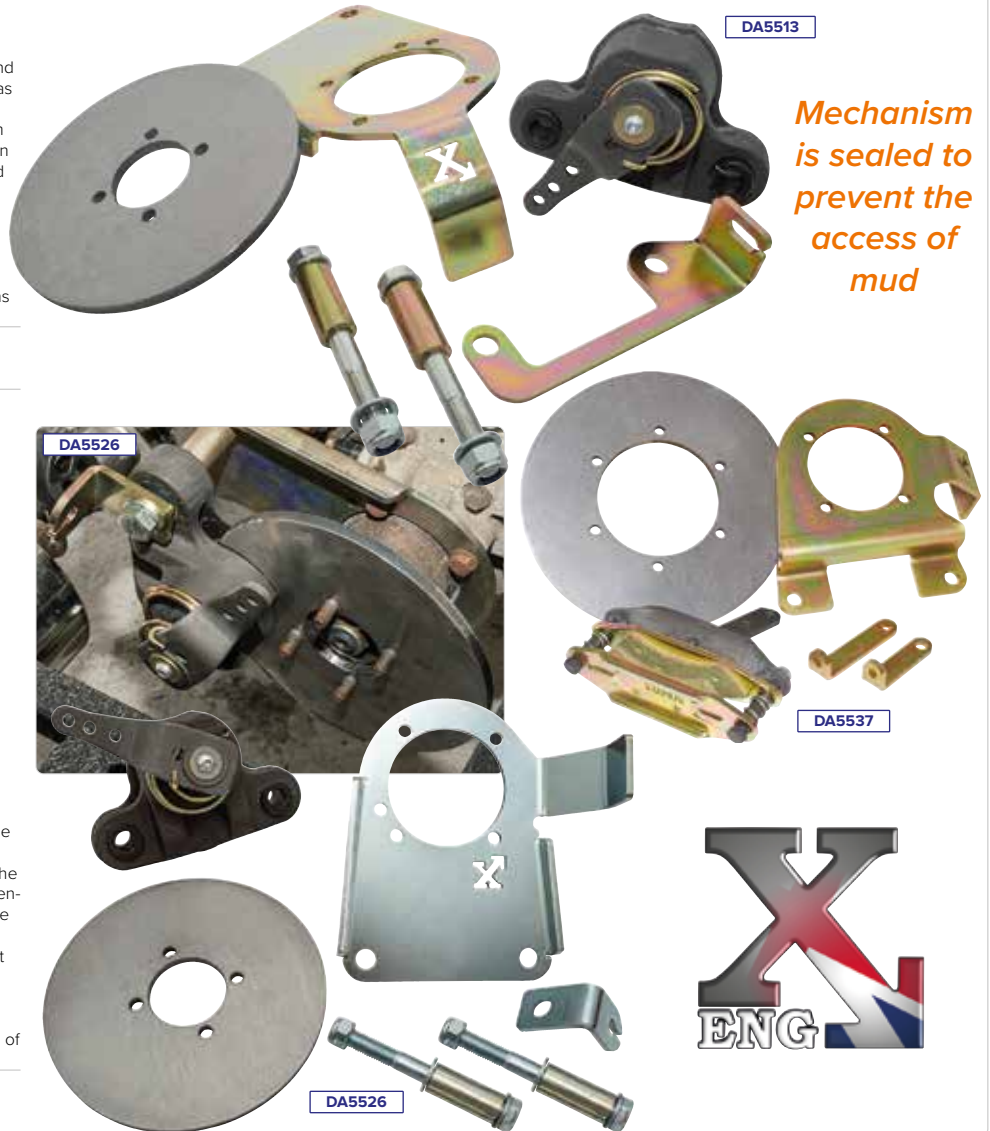

**Mechanism is sealed to prevent the access of mud**

Engine

PRORAM Induction Kit

**DA3492 NEW**

**PRORAM Induction Kit**

Defender - 5.0 V8 - 2020 onwards

The PRORAM kit features a performance synthetic nanofibre air filter, a twin-tangential velocity stack, designed to optimise airflow. It offers proven performance gains - especially with a tuned vehicle.

Designed to fit directly to the standard OEM factory air box mounting points and rubbers without the need for any modifications.

The heat shield helps maintain low intake temperatures by providing a physical barrier between the air filter and the rest of the engine bay.

**What Does It Do?**

This induction kit will increase the airflow into the supercharger while increasing engine noise over the restrictive factory air intake system. This kit includes everything required for the fitting of the induction kit.

Ramair Filters utilise the top-quality components in all their kits which includes:

2 x Black powder coated bespoke heat shields.

2 x Proram performance pleated filters.

2 x Silicone hoses.

All ancillaries/fittings required for complete retrofit installation including easy step by step instructions.



Air Filters - K&N

**DA4275**

K&N Dirt retention lubricating oil  
204ml aerosol

**DA3136**

K&N Cleaning solution  
946ml bottle

**DA3137**

K&N Cleaning kit  
Cleaning Fluid  
355ml  
Lubricating Oil  
204ml



Britpart



### Aluminium Tanks



DA4748

**No More Leaks!!**

#### DA4748 Upgraded Engine Breather Oil Catch Tank

200Tdi & 300Tdi engines  
Allisport high performance aluminium engine breather oil catch tank separator. Manufactured using mounting flange machined from billet aluminium. All engines need to breathe crankcase pressure to atmosphere and most are designed to re-enter the air intake system after the air cleaner. Standard breather pots use a gauze and mesh design which over time becomes blocked with oil deposits, reducing the capacity to release crankcase pressure and also allowing more oil vapour to enter the intake system. This high performance replacement is designed to effectively reduce crankcase pressure build up on Tdi engines by using an internal baffle rather than the standard gauze and mesh design. Designed to have a practical purpose offering an improvement over the original black plastic units, but will also look great in the engine bay. Will fit all Tdi engines including 2.8 TGV. Tank has new integral o-ring-seal design. Manufactured by hand, fully TIG welded.

DA4750



DA4751



This is a direct replacement for the original plastic tank which is prone to splitting. TIG welded by hand and manufactured from high specification lightweight non-corrosive alloy, this tank also aids cooling. Tank uses original pressure release screw cap and is a straight fit with no modifications required. Ideal for motorsport, overland or just to improve the look of your engine bay.

**DA4750**  
Defender - 200Tdi/300Tdi/V8  
Discovery 1 - 200Tdi/300Tdi/V8  
Range Rover Classic  
- petrol & diesel - 1990 onwards

**DA4751**  
Defender - Td5 & Td4 Tdci

### EGR Blanking Kits & Tubes



DA1108



DA1109



DA1112



DA1087 / DA1088



DA1109



DA1272



DA1108TDI



DA1109DEF



DA1109DIS

**DA4749 NEW**  
**Aluminium Power Steering Reservoir with Internal Baffle**  
Defender - Tdi, Td5, Tdci & V8  
Designed to replace the plastic ZF reservoir which is prone to splitting and leaking vapour through the breathable cap, which in turn then collects dirt and runs the risk of water ingress. The external breather design means no unsightly mess under the bonnet and allows routing with high axle/gearbox breathers to eliminate water ingress. Manufactured from laser cut 2mm high grade aluminium with CNC machined pipe connections, knurled cap and external breather. The corrosion resistant aluminium rolled body is fully TIG welded by hand in house. 110mm high (155mm height including cap) & 91mm diameter.



DA1087FL



Britpart

### Filter Guards

- > Extends engine life
- > No vehicle modification needed
- > Added protection for stop & go driving and towing
- > Improves fuel economy
- > Cleans engine oil for 50,000 miles

Britpart Filter Guard removes potential engine damaging metal particles from your oil. Clean oil works better than dirty oil with reduced friction and less wear. Britpart's Filter Guard is an inexpensive way of removing the harmful contaminants that conventional oil filters can miss. The contaminants are fine metal particles which act like an abrasive on the fast moving parts in your vehicle's engine - dramatically shortening engine life. Filter Guard works by magnetic filtration technology resulting in cleaner oil which your engine will thank you for by running better now and in years to come. The Filter Guard will never clog or restrict the all important oil flow.

**Note** - Filter not included with Filter Guard. Please check that there is sufficient room for the addition of the filter guard.

**DA6080**  
Fits filters - AEU2218L & ERR3340  
Defender/Discovery 1/Discovery 2  
Range Rover Classic/Range Rover P38  
Diameter x height - 95 x 30mm  
Thread/Insert - 3/4" x 16

**DA6081**  
Fits filter - RTC3186  
Range Rover Classic  
Diameter x height - 95 x 30mm  
Thread/Insert - 9/16" x 16

**DA6082**  
Fits filters - LPW100180L, LPW100230, STC974 & CDU1268  
Discovery 1/Freelander 1  
Diameter x height - 77 x 30mm  
Thread/Insert - 9/16" x 16

**DA6084**  
Fits filter - LR007160  
Discovery 3  
Range Rover Sport - 2005 - 2009  
Range Rover L322  
Diameter x height - 77 x 30mm  
Thread/Insert - 1" x 12



**BRITPART**  
The quality parts for Land Rovers  
**FILTER GUARD**

**Added protection for your engine!**



**Air Filters - Britpart Performance**

- > A range of performance filters tailored to fit your Land Rover.
- > Maximum breathing efficiency for your engine means more power or better fuel mileage.
- > No compromise on quality - the engine gets more air but the dirt particles are trapped by the quality filters.
- > No need to replace as easy cleaning means maximum performance guaranteed.
- > Easy fit, directly replaces standard air filter.
- > Ideal for use in hot dusty conditions to reduce engine wear.
- > Compatible with snorkels, ideal for use in conjunction with other performance modifications.
- > Filters don't need pre-oiling and if the filter gets dirty there is no need to use a cleaner to clear the dirt on the filter - just use air, water or detergent.

A breath of  
**fresh air**  
for your  
Land Rover



*"Breathing efficiency for your engine means more power or better fuel mileage"*

**Corresponds to**

<b>Series 3</b>			
<b>DA3138</b>		4-cylinder - fits Zenith and Weber carbs	
<b>DA4274</b>	605191	LWB - 3.5 V8 - 2 filters required	1979 - 1982
<b>Defender</b>			
<b>DA4269</b>	NRC9238	2.5 petrol	1983 - 1990
<b>DA4269</b>	NRC9238	2.5 D & Td	1983 - 1990
<b>DA4270</b>	NTC6660	2.5 200Tdi	1990 - 1993
<b>DA4262</b>	NTC1435	2.5 300Tdi	1994 - 1997
<b>DA4262</b>	ESR2623	2.5 300Tdi	1994 - 1997
<b>DA4260</b>	ESR4238	Td5	1999 - 2007
<b>DA4379</b>	PHE500060	Puma	2007 -
<b>Discovery 1</b>			
<b>DA4274</b>	605191	3.5 V8 carb - 2 filters required	1989 - 1990
<b>DA4262</b>	NTC1435	2.5 200Tdi	1989 - 1992
<b>DA4262</b>	ESR2623	2.5 200Tdi	1989 - 1992
<b>DA4268</b>	RTC4683	3.5i V8 Efi	1990 - 1993
<b>DA4261</b>	ESR1445	2.0i Mpi petrol	
<b>DA4261</b>	ESR1445	2.5 300Tdi	1994 - 1997
<b>DA4261</b>	ESR1445	3.9i V8	1994 - 1997
<b>Discovery 2</b>			
<b>DA4260</b>	ESR4238	Td5	1999 - 2004
<b>DA4260</b>	ESR4238	4.0i	1999 - 2004
<b>Discovery 3</b>			
<b>DA3139</b>	PHE000112	2.7 V6 diesel, 4.0 V6 petrol & 4.4 V8 petrol	
<b>Discovery 4</b>			
<b>DA3139</b>	PHE000112	2.7 V6 diesel, 3.0 V6 diesel & 4.0 V6 petrol	
<b>DA4376</b>	LR011593	5.0 V8 - nat. asp.	
<b>Discovery Sport</b>			
<b>DA4637</b>	LR029078	2.0 petrol & 2.2 diesel	
<b>Freelander 1</b>			
<b>DA4267</b>	ESR4103	1.8 16v	1997 - 2000
<b>DA4267</b>	ESR4103	2.0i Tcie diesel (Rover engine)	1997 - 2000
<b>DA4263</b>	PHE100500L	2.0 Td4 (BMW engine)	2001 - 2006
<b>DA4260</b>	ESR4238	V6 petrol	
<b>Freelander 2</b>			
<b>DA4375</b>	LR005816	Petrol & diesel	
<b>DA4637</b>	LR029078	from CH000001 - 2.0 petrol	

**Corresponds to**

<b>Range Rover Classic</b>			
<b>DA4274</b>	605191	3.5 V8 carb - 2 filters required	1972 - 1986
<b>DA4272</b>		3.5 carb V8 - cone type off-road extreme power filter	2 filters required
<b>DA4266</b>		3.5 carb V8 - cone type - replaces 605191	2 filters required
<b>DA4268</b>	RTC4683	3.5i V8 Efi	1985 - 1989
<b>DA4262</b>	NTC1435	2.4D VM Turbo	1986 - 1992
<b>DA4262</b>	ESR2623	2.4D VM Turbo	1986 - 1992
<b>DA4262</b>	NTC1435	2.5D VM Turbo	1986 - 1992
<b>DA4262</b>	ESR2623	2.5D VM Turbo	1986 - 1992
<b>DA4268</b>	RTC4683	3.9i Efi	1989 - 1994
<b>DA4273</b>		3.9i Efi - replaces complete air filter box	1989 - 1992
<b>DA4261</b>	ESR1445	3.9i V8 Efi	1992 - 1994
<b>DA4265</b>	ESR341	4.0i V8	1990 - 1995
<b>DA4265</b>	ESR341	4.2i V8	1990 - 1995
<b>DA4265</b>	ESR341	4.6i V8	1990 - 1995
<b>DA4261</b>	ESR1445	2.5 300Tdi	1993 - 1995
<b>Range Rover P38</b>			
<b>DA4265</b>	ESR341	Diesel up to TA346793	
<b>DA4265</b>	ESR341	Petrol up to TA346793	
<b>DA4260</b>	ESR4238	Diesel from TA346794 up to VA376579	
<b>DA4260</b>	ESR4238	Petrol from VA346794 up to VA376579	
<b>DA4260</b>	ESR4238	Diesel from WA376580	
<b>DA4260</b>	ESR4238	Petrol from WA385949 up to WA410481	
<b>DA4265</b>	ESR341	Petrol from WA376580 up to WA385948	
<b>DA4260</b>	ESR4238	Petrol from XA410482	
<b>Range Rover Sport</b>			
<b>DA3139</b>	PHE000112	2.7 V6 diesel, 4.0 V6 petrol & 4.4 V8 petrol	2005 - 2013
<b>DA4376</b>	LR011593	5.0 V8 nat. asp. & supercharged	2010 - 2013
<b>DA4376</b>	LR011593	5.0 V8 supercharged	2014 -
<b>Range Rover L322</b>			
<b>DA4378</b>	PHE000050	4.4 V8 (BMW engine)	2002 - 2005
<b>DA4377</b>	PHE500021	4.4 V8 nat. asp.	2006 - 2009
<b>DA4377</b>	PHE500021	4.2 V8 supercharged	2006 - 2009
<b>DA4377</b>	PHE500021	3.6 Td8	2007 - 2009
<b>DA4259</b>	PHE000040	Td6	2002 - 2009
<b>DA4376</b>	LR011593	4.4 Td8	2010 - 2012
<b>DA4376</b>	LR011593	5.0 V8 nat. asp. & supercharged	2010 - 2012
<b>Range Rover Evoque</b>			
<b>DA4637</b>	LR029078	2.0 petrol & 2.2 diesel	



To see an image of each filter go to [www.britpart.com/filters](http://www.britpart.com/filters)

*"Filters don't need pre-oiling"*



# PERFORMANCE

## Engine

### High Output Heater Matrixes



DA4743



DA4744

AlliSport uprated high output heater matrixes with high quality vacuum brazed cores and louvred fins. These larger matrixes have twice the capacity of standard which increases heat output and improves windscreen demisting times. TIG welded by hand. Only requires some small mods to the heater box to install.

**DA4743**

Defender - early models with downward facing pipes. Equivalent to AAP817.

**DA4744**

Defender - late models with horizontal inlet/outlet pipes. Right hand drive (including some LHD NAS spec). Check your application before ordering. Not suitable for Puma 2.4 and 2.2 vehicles. Equivalent to UTP1725.



### Intercoolers - Performance

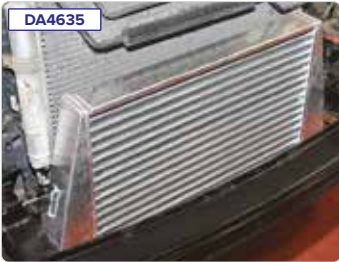

DA4635



*These high performance and robust units are constructed from polished aluminium and are 30% larger than the standard intercooler.*

*As a result air has a chance to cool before entering the engine. This cooler air can increase engine power by up to 25bhp (subject to application).*

*Other benefits include better throttle response and reduction in fuel consumption depending on driving conditions. Ideal for on or off road use.*

*Fully pressure tested, capped and sealed.*

**DA4635**

Discovery 3 - 2.7 TdV6  
Range Rover Sport - 2.7 TdV6  
The original Land Rover intercooler design can have problems due to the blocking up of the core with mud when the vehicles are used off road, as the intercooler is mounted at the lowest point in the front of the vehicle. This intercooler is designed to be easier to clean and less prone to blockage due to the coarser, less dense fin design whilst dramatically improving flow, performance and economy, even without any further tuning. Tests have shown a minimum improvement in fuel economy of 12-15%. Power and throttle response in the lower and mid-range engine revs particularly are noticeably improved. The intercooler is designed to be simple to install without major modifications to the vehicle. The performance intercooler makes full use of the space available behind the bumper. It is designed with an integral fan cowl extension to ensure no loss of cooling efficiency and is supplied with mounting brackets and fitting guide.

**Defender comparison - performance vs standard**

<b>DA4634</b>	Defender 90/110 - Td5 & 2007 onwards including air-con vehicles	60mm D x 300mm H
<b>DA4631</b>	Discovery 2 - Td5 - Automatic/manual with transmission oil cooler - 1999 - 2004	60mm D x 235mm H
<b>DA4632</b>	Discovery 2 - Td5 - Manual without transmission oil cooler - 1999 - 2004	60mm D x 300mm H
<b>DA4633</b>	Range Rover P38 - DSE	60mm D x 280mm H

**Note** - Dimensions for main intercooler body only. If you have a winch fitted please check clearance before fitting.

DA4634



*Better Throttle Response & Reduction In Fuel Consumption*

*Increase Engine Power*



DA4635



DA4631



DA4632



DA4633

### Starter Motors



**NAD10040HD**

Defender - 2½ petrol 4-cylinder

**NAD101490HD**

Defender - V8/Discovery 1 - V8

Discovery 2 - V8

Range Rover P38 - V8 - 1994-2001

**RTC5225HD**

Series 3 - 2¼ petrol

**RTC5232HD**

Series 3 - 2¼ diesel



RTC5232HD

**Powerlite Starter Motors**

High torque gear reduction starter motors. These lightweight units offer increased cranking speeds and considerably more cranking power than original units, whilst drawing less current from the battery.

*More information and images online at [www.britpart.com](http://www.britpart.com)*

### Defender Td5 Alloy Intake Pipe Kit

**DA3421 NEW**

Defender - Td5  
Original hard intake pipe upgrade for Defender Td5 engines. Eliminates intake hose collapsing under induction, common with tuned engines and larger turbos. Made from individually laser cut aluminium cones to smoothly transition from air flow meter connection to turbo inlet.

Unlike many copies which use a sharp reducing hose causing a restriction, each segment is rolled and welded by hand - gradually reducing the diameter to create a smooth air flow. Induction air is under negative pressure and requires as smooth a transition as possible and this gradual reduction in size acts as a venturi; helping to speed up air entering the turbo. Includes CNC machined breather take off, making this a direct replacement part.





Britpart Silicone Turbo Hose Kits

DA3170B	Defender - 200Tdi	4 piece kit	Intercooler hose kit
DA3171B	Defender - 300Tdi	3 piece kit	Intercooler hose kit
DA3173B	Defender - Td5	3 piece kit	Intercooler hose kit
DA3174B	Defender - 2.4Tdc	2 piece kit	Intercooler hose kit
DA4578	Defender - 2.2Tdc	2 piece kit	Intercooler hose kit
DA3209	Defender - 2007 onwards	1 piece	Engine to intercooler (LR066344)
DA3210	Defender - 2007 onwards	1 piece	Air inlet connector (LR067644)
DA3175B	Discovery 1 - 200Tdi	3 piece kit	Intercooler hose kit
DA3176B	Discovery 1 - 300Tdi	3 piece kit	Intercooler hose kit
<p>&gt; Quality silicone hoses are designed to operate at a higher temperature than the original hoses</p> <p>&gt; Will not rot or perish like rubber hoses</p> <p>&gt; Hoses will fit with both standard and performance intercoolers</p>			
DA3177B	Discovery 2 - Td5	4 piece kit	Intercooler hose kit
DA3177BCOM NEW	Discovery 2 - Td5	5 piece kit	Intercooler hose kit with pipe
DA3183	Discovery 3/Discovery 4	1 piece	Intercooler to duct hose (PNH500025)
DA4577	Discovery 3/Discovery 4	3 piece kit	Intercooler hose kit
DA3184	Freelander 1 - Td4	1 piece	Intercooler to turbo hose (PNH10181)
DA3182B	Freelander 1 - Td4	2 piece kit	Intercooler hose kit
DA4582	Freelander 1 - Td4	3 piece kit	Intercooler hose kit
DA4699	Freelander 2 - Td4 2.2	2 piece kit	Intercooler hose kit
DA4699COM	Freelander 2 - Td4 2.2	3 piece kit	Intercooler hose kit (LR066429)
DA3183	Range Rover Sport - 2.7 TdV6	1 piece	Intercooler to duct hose (PNH500025)
DA4577	Range Rover Sport - 2.7 TdV6	3 piece kit	Intercooler hose kit
DA4579	Range Rover Sport - 2005 - 2013 - TdV8	6 piece kit	Intercooler hose kit
DA4580	Range Rover L322 - 3.6 TdV8	6 piece kit	Intercooler hose kit

Britpart Silicone Heater Hoses

DA3213



DA3212



**Will not rot or perish!**

DA3212 Heater hose outlet pipe  
Defender - 300Tdi - Right hand drive

DA3213 Heater hose inlet pipe  
Defender - 300Tdi - Right hand drive

DA3491 NEW Heater hose kit  
Discovery 2 - Td5

DA3498 NEW Heater hose kit  
Discovery 1/Range Rover Classic - 300Tdi



Britpart Silicone Coolant Hose Kits

DA4571	Defender - 200Tdi	5 piece kit	Coolant hose kit
DA4570	Defender - 300Tdi	3 piece kit	Coolant hose kit
DA4572	Defender - Td5	1 piece	Coolant top hose kit
DA4573	Defender - Td5	2 piece kit	Coolant hose kit
DA4575	Defender - 2.4Tdc - 2007 - 2012	5 piece kit	Coolant top hose kit
DA4568	Discovery 1 - 200Tdi	3 piece kit	Coolant hose kit
DA4567	Discovery 1 - 300Tdi	3 piece kit	Coolant hose kit
DA4569	Discovery 2 - Td5	1 piece kit	Coolant top hose kit
DA3387 NEW	Discovery 2 - Td5 - up to 3A828206	2 piece kit	Coolant hose kit
DA3388 NEW	Discovery 2 - Td5 - from 3A828207	2 piece kit	Coolant hose kit
DA4574	200Tdi & 300Tdi engines	3 piece kit	Expansion tank bleed kit
DA4781	Range Rover L322 - TdV8	2 piece kit	Coolant top hose kit
For complete kit see DA4580 above			

- > Quality silicone hoses are designed to operate at a higher temperature than the original hoses
- > Will not rot or perish like rubber hoses
- > Fits with both standard and performance intercoolers

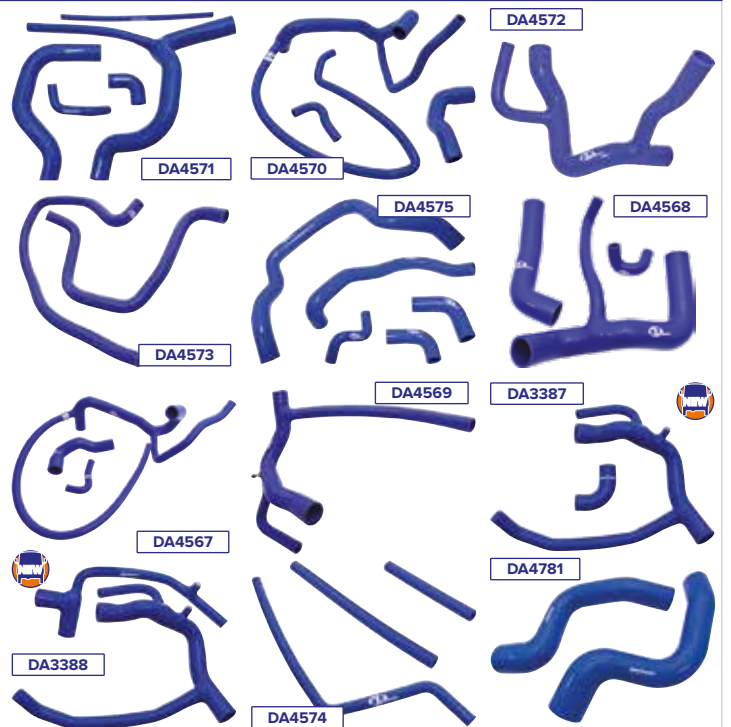

Britpart Silicone Breather Hose Kits

DA3386



DA3385



DA3386 NEW  
Defender 200Tdi  
3 piece kit  
Hoses in kit - ERR1729 / ERR1605 / ERR877

DA3385 NEW  
Defender - 300Tdi  
3 piece kit  
Hoses in kit - LLH500200 / LLH500190 / LLH500170





### Electronic Fan Kits

#### Revotec Electronic Fan Conversion Kits

Revotec cooling kits undergo a rigorous development which includes, radiator air flow performance testing at COMEX to ensure the fan(s) used outperform the original setup. The final stage is extensive road testing before release. The latest fan and controller technology used together with vehicle specific fan mounting brackets, for the ultimate cooling package.

- > Custom engineered to fit and cool your Land Rover perfectly
- > Supplied complete with all necessary fittings and fixings to complete an electronic fan conversion on your vehicle. Kits include mounting brackets or shroud, 35mm Revotec electronic fan controller designed for Land Rovers with an extended loom, earth wire kit and bolts & fixings
- > Engineered to fit without any permanent modifications and utilising original radiator mountings
- > Easy to install with basic hand tools
- > Latest fan and controller technology used together for the ultimate cooling package

#### Benefits of fitting an electric fan

- > Engine reaches operating temperature quickly, reducing wear
- > Sufficient cooling when needed i.e. sitting in traffic idling
- > Overcome hotter running caused by modern fuel
- > Increased performance
- > Improved fuel economy
- > Reduced load on engine

#### Revotec Electronic Fan Controller

- > Adjustable temperature range of 70 - 120°C
- > Instant response
- > No interruption to water flow
- > Simple to install with no leaks!
- > Only 3 wires to connect

#### COMEX Electric Fan

- > Lightweight, slimline body
- > Low noise
- > Finger guard
- > Balanced blades
- > High output, long-life design
- > Rated to run continuously
- > Waterproofed to IP68

#### Fan Mounting Kit

- > No permanent modifications required
- > Vehicle specific brackets
- > Laser cut
- > Engineered to fit perfectly
- > Fitting kit which includes all necessary fittings

<b>DA8963</b>	Series 2/Series 2A/Series 3	14" High power blowing fan
<b>DA8964</b>	Series 3 V8	2 x 12" High power suction fans
<b>DA8965</b>	Ninety/One Ten - 2.5 petrol/2.5 diesel/2.5 TD	15.2" High power suction fan
<b>DA8966</b>	Ninety/One Ten - V8	2 x 12" High power suction fans
<b>DA8967</b>	Defender & Discovery - 200Tdi/300Tdi	15.2" High power suction fan
<b>DA8968</b>	Defender & Discovery - Td5	15.2" High power suction fan
<b>DA8976</b>	<b>NEW</b> Range Rover Classic - AA - 1969 - 1985 - V8 Petrol	2 x 12" High power suction fans
<b>DA8977</b>	<b>NEW</b> Range Rover Classic - GA 1985 - 1993 - V8 Petrol	2 x 12" High power suction fans
<b>DA8978</b>	<b>NEW</b> Range Rover Classic - 92 - 94 Soft Dash - V8 Petrol	2 x 12" High power suction fans
<b>DA8970P</b>	Range Rover P38 - petrol	15.2" High power suction fan
<b>DA8970D</b>	Range Rover P38 - diesel	15.2" High power suction fan

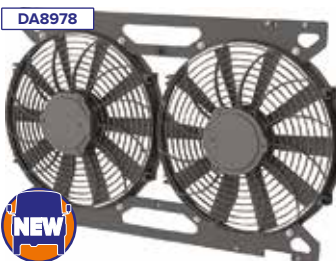
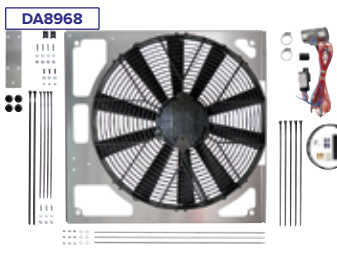
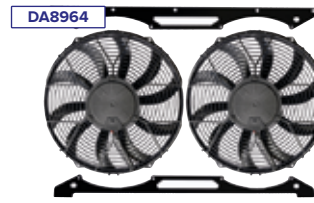
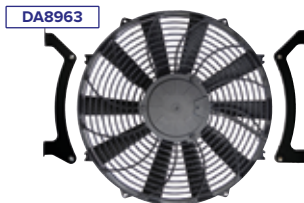

#### Air Conditioning Fans

##### DA8971 Defender

This is a direct replacement to the vehicles original air conditioning fan. Kit contains - 1 x 10" blowing fan.

##### DA8972 Discovery 2

This is a direct replacement for OEM Part No. JRP100000. Kit contains - 1 x 12" high power blowing fan, 2 x anodised brackets & 1 x fixing kit.

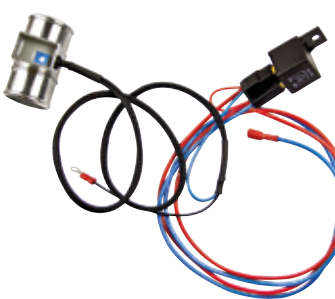

##### DA8973

#### Electronic Fan Controller

- > 35mm
  - > To fit extended loom
  - > Negative earth housing. Fits directly in to a radiator top or bottom hose for direct water contact.
  - > Supply voltage - 12V
  - > Space in hose approx - 35mm
  - > Overall length approx - 65mm
  - > Material - Aluminium
  - > Relay rating - 30 amps
  - > Wire length - 2,500mm
- Kit contains -  
2 x hose clamps, relay, cap, 3 x cable ties, fitting Instructions.

##### DA8974

#### Fan Override Switch

3-way rotary switch for use with a Revotec fan controller enabling the fan to be manually controlled either on, off or automatic. Perfect for 4x4 applications such as wading. This product must be used with a Revotec electronic fan controller.

- Kit contains -
- > Black anodised mounting bracket kit
- > Position decal
- > Sealed 3m wiring loom & connection diagram



Photo by Michael Underdown

# Revotec

Custom  
engineered to  
fit & cool your  
Land Rover  
perfectly



**Tuning Box**



**DA4507**  
Tuning box for the Defender - Puma 2.2Tdc

Power increases by **27bhp** (20kw)  
Torque increases by **71Nm**

The 2011 onwards 2.2 Tdci model Defender has new style piezo injectors and requires specialised tuning solutions. It is currently not possible to remap the ECU through the OBD port. This substantial new tuning unit is designed to plug directly into the wiring loom and requires no modification to the vehicle. Contained in waterproof housing so can be safely located in the engine bay.

**Turbo Boost Box**



**DA4667**  
The Td5 engine fitted in the Defender and Discovery is one of the most 'tuneable' engines available and it responds well to modifications including a PSI power tune box, larger intercooler, EGR removal kit and decat pipes. However the turbo will only boost to 14.7psi in standard form and this will quickly limit the potential from the modifications you have made. The ECU will cut fuel to the engine if it detects an over boosting situation, but there is a solution.

**Turbo Boost Box!** This intelligent box allows the Td5 engine to run with a higher boost pressure after adjusting the waste gate in accordance with the instructions. This allows increased turbo boost pressure without the engine going into limp home mode. You will feel the benefits of fitting the Turbo Boost Box as soon as you drive. At the lower rpm's the vehicle will feel more responsive whilst at the same time giving you a much smoother spread of power through the rpm range. An added benefit is a reduction of exhaust smoke.

Fitting the Turbo Boost Box is an easy 3 wire installation. The box is water resistant - ideal for most off-road uses.

This product must be fitted by a competent mechanic in accordance with the included instructions, incorrect waste gate adjustment can lead to engine damage.

**You will feel the benefits of fitting the Turbo Boost Box as soon as you drive!**

**PSI Power Tuning**

The Power Box houses a digital microprocessor which intercepts the fuelling signals being transmitted from the ECU to the fuel pump; it then modifies them to ensure the exact amount of diesel required for enhanced performance. Such efficient use of the fuel optimises consumption, reduces smoke emissions and there is less engine stress, enhancing engine life in many cases.

The Power Box improves torque enabling the vehicle to change gears earlier and hold higher gears at lower speeds, making driving more pleasurable.

The unit fits using the original manufacturers plugs; these existing plugs are opened and the Power Box is secured in between. Full fitting instructions are included with every unit.

**Features**

- > Plug-in unit
- > No intervention with the original ECU
- > Compact size
- > Shock resistant & waterproof

**Benefits**

- > Can be removed prior to sale or used as a selling point
- > Traceless
- > Peace of mind
- > Quality product which is legal & safe
- > Unobtrusive in interior of vehicle
- > No worries off road
- > A good investment



**Power improvement - before / after**

	Power - HP	Power - Kw	Torque - Nm
<b>DA4418</b> Freelander 1 - Td4 - 2000 - 2006	110 / <b>135</b>	82 / <b>101</b>	260 / <b>309</b>
<b>DA4421</b> Range Rover L322 - Td6 - 2002 onwards	175 / <b>204</b>	130 / <b>152</b>	390 / <b>449</b>
<b>DA4436</b> Defender - 2.4Tdc - 2007-2011 <b>Note</b> - Will not override speed restrictor	121 / <b>153</b>	90 / <b>114</b>	360 / <b>424</b>
<b>DA4435</b> Discovery 4/Range Rover Sport - 3.0 TdV6	252 / <b>286</b>	188 / <b>213</b>	600 / <b>677</b>

*Improves torque*

*Improves m.p.g*

**Tunit Box**



**DA4437**  
Freelander 2 - 2.2 Td4 - 2007 onwards  
Power improvement - before / after

**Power - HP - 152 / 177**

**Power - Kw - 112 / 130**

**Torque - Nm - 295 / 325**

**Tunit Diesel Performance**

The Diesel Tunit has been forged from many years of experience to bring a world class unbeatable range of diesel performance solutions.

**Tunit Features**

Tunit possesses many advantageous features not seen in other tuning solutions such as chips, eeprom serial reprogramming (flashing) or other types of fixed map devices. It is interchangeable between vehicles and able to be upgraded. External to the ECU or 'Plug and play' as it is often called means no interference with the original manufacturers engine equipment. Its option to adjust power and performance provides easy manual adjustment for the novice or finer electronic alterations for the more dedicated tuner.

**"Plug & Play"**

**Fuel Savings**

Tunit has become advantageous in reducing fuel costs for a variety of applications; not just improving performance but now helping with saving fuel costs.

**Installation**

The Tunit is normally connected to original plugs on the vehicle and can either be self-installed or by a professional mechanic.

**Upgrade Chips**



**DA4497**  
Range Rover P38  
**No trade off between fuel economy & increased power!**

Replacement ECU chip to improve power and economy on the GEMS engine 4.0 and 4.6 in the Range Rover P38. Fitting this chip will increase economy by approx 15% and power by 10%. Once fitted, it helps makes a big difference to the driveability of the vehicle by improving throttle response and mid-range pull.

**Accelerate technology**

Limitations and restrictions exist which prevent your vehicle from achieving optimal performance. The manufacturer's emissions test is extremely rigorous due to inclusion of all parts of the driving cycle, especially warm up and full load operation, which is where problem emissions are at a maximum. To meet these they compromise performance and efficiency of the engine - this chip helps redress that balance.

**Off-Roaders in the driving seat**

Your requirements are met through a stable and predictable idle quality, good engine braking and an engine which has plenty of midrange torque. Perfect idle control for hill descents and winching, with no possibility of stalling. Total reliability ensures you never lose control.

**Greater expectations**

By comparison we know climate conditions and fuel quality your vehicle experiences and can therefore improve efficiency by reducing fuel consumption and optimising the engine to get its best performance on full load, which is less than 10% of the time.

**Weber Carburettors**

**DA3049**  
V8 4-Barrel conversion kit including manifold  
The Webcon 4 barrel replacement carburettor kit is a direct replacement for the twin Stromberg or SU carbs fitted to the Rover V8. Calibrated to work perfectly on the 3.5 and 3.9 engines, the Webcon kit is the most complete on the market and features a Webcon modified Weber 4 barrel 500cfm carburettor, intake manifold, air filter and every single nut, bolt washer, gasket and hose that could possibly be needed. The kit adds up to 20bhp at the wheels and transforms the driveability and economy. Starting becomes instant either hot or cold and with no balance adjustment to worry about with twin carbs, the engine is simply superbly smooth as a V8 should be.



**ERC2886W**  
Series - right hand drive  
Replacement for the Zenith 36IV  
The Weber range of carburettor kit replaces the Zenith 36IV to offer the optimum balance of power and economy together with the legendary quality and reliability of Weber. Shipped as complete turnkey solutions, all kits are supplied with every nut, bolt, washer and gasket required and comprehensive, easy to follow instructions ensure that installation can be carried out with no specialist carburettor knowledge.

**DA3049AF**  
Replacement air filter for DA3049

**DA3049KD**  
Weber kick down kit for use with DA3049 on automatic vehicles.

**DA2126**  
Series carburettor - to replace Solex use also STC541 adaptor  
Left hand drive vehicles

**DA2126A**  
Choke cable for DA2126

**DA2206**  
Service kit for DA2126 & ERC2886W



Photo by Ming Lee



### Double 'S' Stainless Steel - Standard Exhaust Systems

Series			
DA3998	Series 1 - 80"	2.0 petrol	Front pipe / link pipe / rear silencer
DA4540	Series 1 - 86 & 88" - 1954 - 1961	2.0 petrol	Front pipe / link pipe / rear silencer
DA4251	Series 3 - SWB	2.25 diesel - 3 stud manifold exit	Front pipe / link pipe / rear silencer
DA4528	Series 3 - SWB - RHD	2.25 petrol	Front pipe / link pipe / rear silencer
DA4528LHD	Series 3 - SWB - LHD	2.25 petrol	Front pipe / link pipe / rear silencer
Defender			
DA4231	Defender 90	200Tdi	Front pipe / centre box / rear silencer
DA4232	Defender 90 - 1994 - 1995	300Tdi	Front pipe / centre box / rear silencer
DA4233	Defender 90 - 1995 - 1997	300Tdi	Front pipe / centre box / rear silencer
DA4234	Defender 90 - 1997 - onwards	300Tdi	Centre box / rear silencer
DA4235	Defender 90	Td5	Centre box / rear silencer
DA2773	Defender 90	2.4 & 2.2	Centre box / rear silencer
DA4228	Defender 110	200Tdi	Front pipe / centre box / rear silencer
DA4229	Defender 110	300Tdi	Front pipe / centre box / rear silencer
DA4244	Defender 110	Td5	Centre box / rear silencer
DA1954	Defender 110	2.4 & 2.2	Centre box / rear silencer
Discovery			
DA4223	Discovery 1	300Tdi	Centre box / rear silencer
DA4224	Discovery 2	Td5	Centre box / rear silencer
DA1945	Discovery 3 & Discovery 4	2.7 TdV6 & 3.0 TdV6	
DA1944	Discovery Sport	2.0 diesel	
Freelander			
DA4226	Freelander 1	1.8 petrol - up to YA999999	Centre box / rear silencer
DA4246	Freelander 1	1.8 petrol - up to YA999999	Transplex rear silencer (2 x 3" roll tailpipe)
DA4227	Freelander 1	2.0 diesel - up to YA999999	Link pipe / rear silencer
DA3249	Freelander 2	Td4	Link pipe / rear silencer / tailpipe
Range Rover			
DA4237	Range Rover Classic - cat & non-cat	3.9 V8 from catalyst to back	Centre box / rear silencer
DA4238	Range Rover P38	2.5 BMW diesel single tailpipe	Centre box / rear silencer
DA4239	Range Rover P38	4.0/4.6 single tailpipe	Centre box / rear silencer
DA4240	Range Rover P38	4.0/4.6 twin tailpipe	Centre box / silencers - RHS & LHS
DA4241	Range Rover P38	2.5 BMW twin tailpipe	Centre box / silencers - RHS & LHS
DA4395	Range Rover Sport	4.2 V8 Supercharged - 2005 - 2009	Centre box / link pipes - RHS & LHS / rear silencers - RHS & LHS
DA6815	Range Rover Sport	4.4 - 2005 - 2009	Front silencer / link pipes - RHS & LHS / rear - RHS & LHS
DA6811	Range Rover L322	4.4 - 2002 - 2005	Link pipes - RHS & LHS / silencer
DA6813	Range Rover L322	4.4 - 2005 - 2009	Link pipes - RHS & LHS / twin rear silencer
DA6814	Range Rover L405	5.0 Supercharged - 2012 onwards	Front silencer / link pipe RHS & LHS / rear silencer RHS & LHS
DA6817	Range Rover Evoque	2.2 - 2011 onwards	Link pipe / Y-section / tail pipe - RHS & LHS

**Double 'S' is recognised as one of Europe's leading manufacturers of stainless steel automotive components with a wide selection of systems for off-road use.**

Using only the finest austenitic and ferritic stainless steels and employing the latest in CNC mandrel and empty tube bending, measuring and inspection equipment, means increasingly high levels of product quality.



All Double 'S' exhaust systems carry a lifetime guarantee. Double 'S' will replace or repair any part of their Stainless Steel Exhaust Systems found defective through corrosion during the period that the system remains the property of the original owner. Provided that the system is inspected by a garage or exhaust fitting centre annually to ensure that the rubber and other mountings are in good condition.



For many more images - [www.britpart.com/double-s](http://www.britpart.com/double-s)

*Using only the finest austenitic & ferritic stainless steels...*

**Double 'S' Stainless Steel - Sports Exhaust Systems**

**Defender**

<b>DA4249</b>	Defender 90	Td5 sports system
Sports centre link pipe / rear silencer*		
<b>DA4236</b>	Defender 90	3.5 V8 sports system
Manifolds - RHS & LHS / Y-Pipe / rear silencer / tailpipe / fitting bracket & kit		
<b>DA1949</b>	Defender 90	2.2 sports system
Sports centre link pipe / rear silencer*. No front pipe.		
<b>DA2774</b>	Defender 90	2.4 sports system
Sports centre link pipe / rear silencer*. No front pipe.		
<b>DA1956</b>	Defender 110	2.2 sports system
Sports centre link pipe / rear silencer*. No front pipe.		
<b>DA2776</b>	Defender 110	2.4 sports system
Sports centre link pipe / rear silencer*. No front pipe.		
<b>DA4230</b>	Defender 110	3.5 V8 sports system
Manifolds - RHS & LHS / Y-Pipe / extension pipe / centre box / tailpipe / fitting bracket & kit		

**Range Rover**

<b>DA4242</b>	Range Rover Classic	3.5 V8 Efi sports system with tubular manifold
Manifolds - RHS & LHS / Y-Pipe / centre box / rear silencer*		
<b>DA4243</b>	Range Rover Classic	3.9 V8 Efi sports system with tubular manifold
1970 - 1989		
Manifolds - RHS & LHS / Y-Pipe / link pipe / centre box / rear silencer*		
<b>DA4243EXT</b>	Range Rover Classic	Extension piece for DA4243 for use on long wheel base Range Rover Classic LSE models
<b>DA4245</b>	Range Rover P38	4.0/4.6 sports system with twin tailpipe
Rear silencers - RHS & LHS / Y-Pipe / centre box*		
<b>DA4247</b>	Range Rover P38	2.5 diesel sports system with twin tailpipe
Rear silencers - RHS & LHS / Y-Pipe / centre box*		

\*Note - Kits exclude a fitting kit

For many more images - [www.britpart.com/double-s](http://www.britpart.com/double-s)

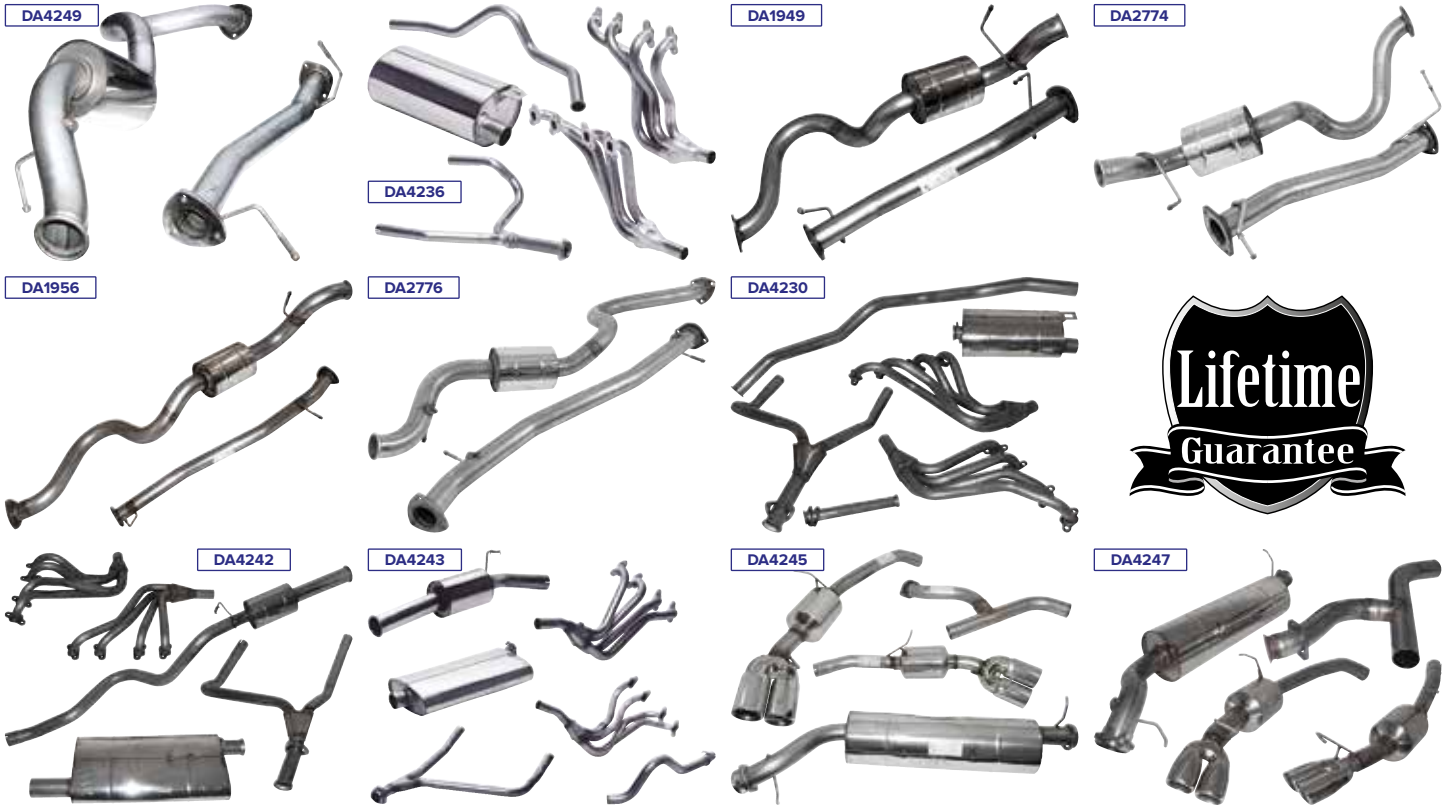

**Saver Sports Exhausts**

<b>DA3550</b>	<b>DA3551</b>	<b>DA3552</b>
---------------	---------------	---------------

Photo by Jane Myers

Made in collaboration with Double S exhausts, these Saver Sports Exhausts are a stainless steel budget system for the cost conscious customer.

Made in the UK, these straight through type 430 silencers offer great weight saving and sound enhanced performance at an affordable price. They use the same internal design as regular Double S stainless steel exhausts.

Exclusively available to Britpart distributors.

<b>DA3550 NEW</b>	Defender 90 - Td5	Centre box / rear silencer
<b>DA3551 NEW</b>	Defender 90 - 2.4 & 2.2	Centre box / rear silencer
<b>DA3552 NEW</b>	Defender 110 - Td5	Centre box / rear silencer
<b>DA3553 NEW</b>	Defender 110 - 2.4 & 2.2	Centre box / rear silencer

Images for illustrative purposes only



# PERFORMANCE

## Exhaust Systems & Components

### Double 'S' Stainless Steel - Exhaust Components

<b>Defender</b>		<b>Discovery 2</b>	
<b>ESR158SS</b>	Front pipe	<b>WDE100590SS</b>	Intermediate silencer
<b>ESR2297SS</b>	Front pipe - non-cat	<b>Freelander 1</b>	
<b>ESR2381SS</b>	Intermediate pipe & silencer	<b>WCE104231SS</b>	Intermediate pipe
<b>ESR2383SS</b>	Intermediate pipe & silencer	<b>WDV500020SS</b>	Rear silencer
<b>ESR3495SS</b>	Front pipe	<b>Range Rover Classic</b>	
<b>ESR358SS</b>	Front silencer	<b>NTC1322SS</b>	Intermediate silencer
<b>ESR4526SS</b>	Centre silencer	<b>Range Rover P38</b>	
<b>ESR545S</b>	Intermediate pipe & silencer	<b>ESR3195SS</b>	Intermediate pipe & silencer
<b>NRC4218SS</b>	Intermediate pipe	<b>ESR3538SS</b>	Rear tailpipe & silencer
<b>NRC4219SS</b>	Front pipe - left	<b>WDV100260SS</b>	Twin tailpipe & silencer - left
<b>NRC6432SS</b>	Front pipe - right	<b>WDV100270SS</b>	Twin tailpipe & silencer - right
<b>NRC6433SS</b>	Intermediate pipe & silencer	<b>Series</b>	
<b>NRC6436SS</b>	Intermediate pipe	<b>244449SS</b>	Intermediate pipe
<b>NRC7842SS</b>	Rear tailpipe & silencer	<b>264195SS</b>	Intermediate pipe
<b>NRC8888SS</b>	Intermediate silencer	<b>500289SS</b>	Intermediate pipe
<b>NRC8889SS</b>	Rear tailpipe & silencer	<b>503456SS</b>	Intermediate pipe
<b>NRC9137SS</b>	Front pipe	<b>517469SS</b>	Front pipe
<b>NRC9836SS</b>	Rear tailpipe & silencer	<b>562731SS</b>	Rear silencer
<b>NTC1149SS</b>	Rear tailpipe	<b>562858SS</b>	Front pipe
<b>NTC1150SS</b>	Rear silencer	<b>598540SS</b>	Rear silencer
<b>NTC1665SS</b>	Intermediate silencer	<b>599378SS</b>	Silencer & tailpipe
<b>NTC1666SS</b>	Intermediate pipe & silencer	<b>624196SS</b>	Front pipe
<b>NTC1800SS</b>	Rear tailpipe & silencer		
<b>NTC2726SS</b>	Y pipe		
<b>NTC2832SS</b>	Rear tailpipe & silencer		
<b>NTC4221SS</b>	Intermediate pipe		
<b>NTC4426SS</b>	Front pipe		
<b>NTC4614SS</b>	Intermediate silencer		
<b>WCE000030SS</b>	Centre silencer		
<b>WCE000040SS</b>	Centre silencer		
<b>Discovery 1</b>			
<b>ESR3495SS</b>	Front pipe		
<b>NTC1322SS</b>	Intermediate silencer		
<b>NTC6791SS</b>	Intermediate silencer		



For many more images  
[www.britpart.com/double-s](http://www.britpart.com/double-s)

### Big Bore Exhaust Tailpipes



**DA1676**  
 Defender 90  
 Td5 & 2007 Puma  
 onwards\*

**DA2779**  
 Defender 110  
 Td5 & 2007 Puma  
 onwards



3" stainless steel  
 big bore straight  
 through tailpipe.  
 No silencer.

\*Not suitable for  
 Australian Defenders

### Exhaust Clamps



<b>DA4062</b>	45mm	Qty 1	<b>DA4063</b>	60mm	Qty 1
<b>DA4186</b>	54mm	Qty 1	<b>DA4064</b>	65mm	Qty 1

### Exhaust Fitting Kits



All you need to replace the exhaust on a Series - SWB.  
**DA1293** Right hand drive  
**DA1294** Left hand drive



Watch Tim & Fuzz  
 from **Car SOS** explore  
 Britpart...



[www.britpart.com/sos](http://www.britpart.com/sos)



**Utility Link Pipes & Rear Silencers**

Britpart Link Pipe		Double 'S' Rear Silencer	
<b>Defender</b>			
DA4371	DA3250	Defender 90 - 2007 onwards	
DA4292	DA3250	Defender 90 - Td5	
DA4294	DA3251	Defender 90 - 300Tdi 1994 - 1995	
DA4294	DA3252	Defender 90 - 300Tdi 1995 - 1997	
DA4304	DA3253	Defender 90 - 300Tdi 1997 - 1999	
DA4295	DA3254	Defender 90 - 200Tdi	
DA4372	DA3255	Defender 110 - 2007 onwards	
DA4293	DA3255	Defender 110 - Td5	
DA4302	DA3256	Defender 110 - 300Tdi	
DA4306	DA3257	Defender 110 - 200Tdi	
<b>Discovery</b>			
DA4291	DA3258	Discovery 1 - 300Tdi	
<b>Note</b> - Will only fit with Double 'S' rear silencer (DA3258)			
DA4303	DA3259	Discovery 1 - 200Tdi	
DA4223S		Discovery 1 - 300Tdi	
<b>Sport system kit</b>			
<b>Note</b> - Kit includes Double 'S' rear silencer (DA3258)			
ESR2391S		Discovery 1 - 300Tdi	
<b>Sport system kit</b>			
<b>Note</b> - Not stainless steel			
DA4290	DA3260	Discovery 2 - Td5	
<b>Freelander</b>			
	<b>Rear Silencer</b>		
	DA4537	Freelander 1 - Td4	Rear silencer

These stainless steel exhaust silencer replacement pipes are designed to directly replace the front silencer in your exhaust system. Once replaced the pipe will give your vehicle more power or reduced fuel consumption with only a small increase in cabin noise. CNC mandrel formed for a perfect fit with laser cut flanges, the pipes have a sateen finish, deep lustre appearance. Quick and easy to install.

**Reduced fuel consumption**



**Quick & easy to install with more power**



Photo by Fay Gadsby

**Front Downpipes**

DA3262	DA3262	300Tdi - downpipe less cat Defender Equivalent to ESR2297
DA4348	DA4348	Td5 - downpipe less cat - mild steel Defender 90 Equivalent to WCD000960 Discovery 2 Equivalent to WCD000500
DA4359	DA4359	2.4 EU4 2007 onwards - downpipe less cat Defender 90 Equivalent to LR020683
ESR2740	ESR2740	300Tdi - downpipe less cat Discovery 1 Range Rover Classic Equivalent to ESR2440
DA4396	DA4396	TdV6 - downpipe less cat Discovery 3 Equivalent to WCD500433

**Note** - Fitting downpipe may then require vehicle needing an engine re-map by a specialist.



Photo by Sirsendu Gayen



### Roamerdrive Overdrive Units

<b>Defender</b>	
<b>DA9017</b>	Overdrive Unit
<b>DA9019</b>	Replacement Rubber Gaiter

Defender - up to 2007

The distinctive third lever on the centre console of a Defender identifies it as a vehicle equipped with a Roamerdrive overdrive. This rugged, bolt on accessory has been proven in hundreds of installations and tested under the most demanding expedition conditions. No other modification improves the performance and economy of your Land Rover like a Roamerdrive. The DS model overdrive is an auxiliary gearbox that is easily fitted to a Defender 90 or 110 with standard five speed transmission. The unit adds an optional 28% to the ratio of the drive train giving improved fuel economy. Reduced engine speed contributes to quieter more comfortable travel under motorway conditions and reduces wear and tear on mechanical components. The Roamerdrive is a completely mechanical device built in the tradition of rugged dependability that has made Land Rover the world's favourite expedition vehicle. These overdrives have no electronic or hydraulic components. They are controlled by moving the convenient hand lever. Unlike a high ratio transfer case that will permanently detract from the versatility of the gearbox, the Roamerdrive does not alter the vehicle's designed gear ratios. Off road performance is enhanced as the overdrive ratio can be added to any gear in high or low range.

The Roamerdrive uses the same epicyclical gear technology as a modern automatic transmission and runs quietly. This is particularly evident at high speeds and makes driving a Defender for long distances a pleasurable experience. On long journeys Roamerdrive users have reported fuel savings of up to 18% - not surprising when you consider that the engine lopes along the highway at about 2,000rpm - a favourable spot on the diesel torque band. Although precise fuel savings will depend on your driving habits.



DA9017



DA9017



DA1285



DA9018



DA9016



*Reduced engine speed contributes to quieter more comfortable travel under motorway conditions and reduces wear & tear*

#### DA9029 Transfer Case Dipstick Kit

Series 1, 2, 2A & 3

If you do not own a Roamerdrive (DA9015), you can buy a handy dipstick kit that will enable you to check the oil level in your transfer case by simply lifting out the centre seat. The kit consists of a dip-stick tube that screws into the level plug and a replacement top cover with a filler plug.



DA9029

#### DA9018 Transfer Case Sump Cover

Fits models fitted with 230 type transfer case. Defender - up to 2007, Discovery 1 & Range Rover diesel.

Billet transfer case sump oil coolers are designed to replace the flimsy sump covers supplied as standard equipment. These covers are stronger than the originals and have cooling fins to keep the oil in your transfer case cool in harsh conditions. The sump cover is supplied with a new gasket, and the existing bolts are used for installation. The sump cover is significantly stronger than the original and adds about 1/2 litre to oil capacity. Existing ground clearance is not compromised. A plugged port is supplied so that DA1285 oil temperature gauge can be fitted. It is possible to fit this sump cover to V8 models but check first that there is good clearance between the cover and existing exhaust pipes.

#### DA1285 Oil Temperature Gauge

This oil temperature gauge is a high precision mechanical temperature gauge with a full 270 degree sweep. The unit is designed to compliment DA9018 transfer case sump cover and fits directly to a pre-drilled port in the sump cover. The unit fits into a standard two inch mounting hole and operates completely independently of electrical power. A 12 volt light supplies illumination. The gauges are far more accurate than common electrical types using thermistor senders. These gauges can also be used to measure cooling water temperature or engine oil temperature in commercial or marine applications. The sending tube is 1,800mm long, and contains pressurised fluid so it cannot be shortened - but you can coil surplus tube behind your dash.

#### Series DA9015 Overdrive Unit

Series

DA9015 Overdrive Unit

The distinctive extra lever on the right hand side of the transmission tunnel on a Series 1, 2 or 3 shows that it is equipped with a Roamerdrive. Since 2002 the majority of new overdrives fitted to these timeless vehicles have been simple rugged units. Proven in hundreds of installations worldwide, this rugged and well engineered product will improve the performance and economy of your collectable Land Rover. The SS model Roamerdrive is an auxiliary gearbox that is easily fitted to a Series 1, 2 or 3 with a 4 or 6 cylinder engine. The unit adds an additional 28% to the ratio of the transmission giving improved fuel economy. Reduced engine speed contributes to quieter more comfortable travel at motorway speeds and extends the life of drive train components.



The Roamerdrive is a completely mechanical device built in the same tradition of rugged dependability that has made Land Rover the world's favourite expedition vehicle. These overdrives have no electronic or hydraulic components. They are engaged or disengaged by moving a convenient lever.

Unlike a high ratio transfer case that will permanently detract from the versatility of the gearbox, the Roamerdrive does not affect the vehicle's designed gear ratios. The unit provides useful 'splitter' gears such as a gear ratio midway between conventional third and fourth.

The Roamerdrive uses the same epicyclical gear technology as a modern automatic transmission and is very quiet running. This is particularly evident at higher speeds and makes driving a Series Land Rover for long distances a more pleasurable experience. Fuel savings will depend on your driving habits. On long journeys Roamerdrive users have reported fuel savings of up to 18%.

#### DA9016 Transfer Case Sump Cover

Fits all Land Rover Series 1, 2, 2A and 3 models (except V8)

Billet transfer case sump oil coolers are designed to replace the flimsy sump covers supplied as standard equipment. These covers are stronger than the originals and have cooling fins to keep the oil in your transfer case cool in harsh conditions. This Series model is supplied with a new gasket and replacement fastening bolt to replace the brittle standard studs. Being solid aluminium, the cover completely eliminates leaks caused by differential expansion. If your vehicle is pre 1980 you can use your existing drain plug and washer. Owners of Later Series Vehicles with Metric fasteners should purchase a plug (Land Rover part 235592) to fit the threads in this casting. As the cover expands at the same rate as the aluminium transfer case the stubborn oil leaks associated with the original steel cover are completely eliminated.



DA9015



Photo by Sourav Mishra



Garage Therapy Overdrive Unit

DA3338 NEW

Garage Therapy Overdrive Kit - 4-Speed (LT95)

Range Rover Classic 1970-1983

The kit includes:

- > GT-LT95 overdrive
- > 2 piece LT95 coupling
- > Coupling spacer
- > Finned transfer case cover and gasket
- > Digital temperature gauge kit including 2 sensors
- > Overdrive selector kit
- > Installation manual

It has been specifically designed to fit the restricted space of the 1970 - 1983 Range Rover Classic that use the Rover LT95 gearbox. Comes with everything required to complete the installation. Because the overdrive has been designed to fit onto the PTO flange area of the Land Rover LT95 gearbox, you can enjoy the 28% overdrive in any gear, including reverse, and in high or low range.

Garage Therapy have worked closely with Global Roamer Corporation of Canada to develop a robust overdrive that will allow you to enjoy quieter, more fuel-efficient cruising on motorways and the ability to split every gear while towing heavy loads. It also allows you to overdrive all gears in low range, reducing engine noise and wear on those long sandy tracks and beaches.

The GT-LT95 overdrive takes advantage of Global Roamer's legendary epicyclic gear train technology as used in their Roamerdrive overdrives. Also known as planetary gear sets, they are well known for their strength and silent operation. Global Roamer Corporation has a worldwide population of many thousands of overdrives using this very same bullet-proof technology.

Many of the older style 'layshaft' overdrive units suffered badly from a lack of lubrication. The GT-LT95 is designed to be open to the transfer case and utilises an innovative lubrication system which directs transfer case oil through the overdrive gearbox and back to the transfer case via a large deep groove ball bearing.

As with all gearboxes, lubrication failure due to excessive heat, lack of supply, or both, is to be avoided at all costs. To handle the extra heat generated by the overdrive gearbox, a finned transfer case cover is included which doubles the heat rejection compared to the standard cover. If even more cooling is required for high speed, high load in hot climates, the cover has ports for an optional oil cooler and manual temperature sensor.

To assist this, an accurate digital temperature gauge is supplied. This very clever gauge uses simple lug style sensors that can monitor both engine and gearbox temperature. Unlike traditional sensors, they operate independent of oil level. It even has an optional exhaust gas temperature thermocouple available; perfect for turbocharged applications. Not only does the gauge have simple to understand icons that change colour if safe limits are exceeded, it also has a series of audible alarms so you never miss that vital warning.



You can enjoy the 28% overdrive in any gear



Heavy-Duty Axles

Defender heavy-duty axles are a straight replacement for your existing axles and offer substantial protection.



- > CNC cut
- > Exact replacement
- > 6 - 10mm steel
- > Powder coated
- > Heavy-duty mounts

DA1706 Short nose rear non-ABS axle  
DA1707 Long nose rear non-ABS axle



Photo by Peter Schulz





Photo by Martin Price



Ride Smoothly With  
Suspension & Axle  
Upgrades

# SUSPENSION & AXLE



### Anti-Roll Bar Kits



Defender 90, 110 & 130/Discovery 1/Range Rover Classic

**STC8156AA**

Black

Rubber bushes

**STC8156AAPY**

Yellow

Britpart yellow polyurethane bushes

Stiffen up your Land Rover! Front and rear kits complete with fitting instructions. Only suitable for vehicles with the chassis and axle brackets fitted.

**Note** - Additional parts needed to fit these anti-roll bars to the rear of a Defender

Defender 90 Td5 - onwards

2 x EGP1661L & 2 x EGP1889

Defender 110/130 Td5 - onwards

2 x NRC5674 & 2 x 592773

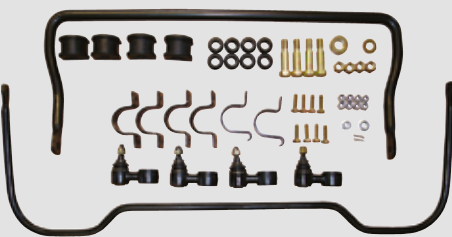

### Fulcrum Brackets

Defender/Discovery 1  
Range Rover Classic

**DA1129**

With ball joint assembly  
(ANR1799)

**DA1129G**

With OEM ball joint assembly  
(ANR1799G)

**DA1129ADJ**



Defender/Discovery 1  
Range Rover Classic

**DA1129ADJ**

With adjustable ball joint assembly  
(ANR1799A)

**DA1129KIT**

Fitting kit for all  
fulcrum brackets

**DA1129ULTRA**

Fulcrum Bracket with  
High Articulation

Defender

Discovery 1

Range Rover Classic



One of the major factors limiting the rear suspension movement on vehicles fitted with an A-frame is the standard ball joint. We have developed this part to provide significantly more articulation than the standard and most aftermarket joints. Others claim more articulation yet in reality they offer very little over the standard 30°. This exclusive ball joint offers 45° movement in all directions. It is easily adjustable with a regular hex spanner and has a grease nipple for convenient regular maintenance. It is supplied fitted ready to bolt to your Land Rover.

### Castor Corrected Swivel Housings



**DA3203**

Defender - from LA up to WA

**DA2992**

Discovery 1 - JA32851 onwards - non-ABS

Range Rover Classic - JA624517 onwards - non-ABS

#### '3 degrees of additional castor'

Normally the only way to correct the castor angle on a beam axle vehicle is to fit castor corrected radius arms or go through the lengthy process of repositioning the brackets on the axle. Something which takes considerable time and skill. Britpart offer you an alternative. These castor corrected swivel housings come as a handed pair. They are a direct replacement for vehicles normally using the FRC7065 swivel housing but they have the mounting holes positioned to give 3 degrees of additional castor. The swivel housings are from the OEM supplier and then machined to our specification. Kit contents - Swivel housings; swivel pin bearings; gaskets; seals; plates; shims; joint washers; swivel pin uppers - non-ABS & swivel housing grease sachets.

### Heavy-Duty Drive Flanges

**DA1148**



*These heavy-duty drive flange kits have been engineered to outperform many of the inferior products available on the market and are much stronger than an OE drive flange. Kits are complete with hex head bolts and screw on caps with integral seal.*

**DA1148**

Manufactured from chromoly steel - 40CrNiMo

Defender - from LA/Discovery 1 - from JA

Range Rover Classic - ABS and front from JA

**DA1149**

Manufactured from 5140 steel

Defender - up to KA

### Radius Arm & Panhard Rod Bush Kits



Front bush kits include bushes for radius arms and panhard rods. Rear bush kits include bushes for top & bottom links.

**Front Bush Kits**

**DA1242** Range Rover Classic - up to 1985

**DA1244** Defender - up to KA

**DA1244G** Defender - up to KA OEM

**DA1245** Defender - from LA up to VA130784/Discovery 1  
Range Rover Classic - from 1986 onwards

**DA1245G** Defender - from LA up to VA130784  
Discovery 1 OEM

Range Rover Classic - from 1986 onwards

**DA1246** Defender - from VA130785 up to 2A626645

**DA1247** Defender - from 2A626646 onwards

**Rear Bush Kits**

**DA1243** Range Rover Classic - up to 1985

**DA1248** Defender - from VA130785 up to 2A626645

Range Rover Classic from 1986 on

**DA1248G** Defender to 9A768936/Discovery 1 OEM

Range Rover Classic from 1986 on

**DA1249** Defender from 9A768937

### Heavy-Duty Drive Flanges

**DA1148**



**DA1149**

*These heavy-duty drive flange kits have been engineered to outperform many of the inferior products available on the market and are much stronger than an OE drive flange. Kits are complete with hex head bolts and screw on caps with integral seal.*

**DA1148**

Manufactured from chromoly steel - 40CrNiMo

Defender - from LA/Discovery 1 - from JA

Range Rover Classic - ABS and front from JA

**DA1149**

Manufactured from 5140 steel

Defender - up to KA

**RUC105200HD**

Replacement drive flange for DA1148

Manufactured from chromoly steel - 40CrNiMo

**FRC5806HD**

Replacement drive flange for DA1149

Manufactured from 5140 steel

**DA1148CAP**

Drive flange cap with rubber seal

Manufactured from chromoly steel - 40CrNiMo

Replacement for DA1148 & DA1149

**DA1128**

Drive flange bolt set

Replacement for DA1148 & DA1149

**DA2989**

Defender drive

flange bolt caps

Qty 20



**DA2989**

**DA1148CAP**

**DA1128**

### Panhard Rod

**DA1130**

Ninety/One Ten

Defender

Complete with yellow  
polyurethane bush set

If your Land Rover has raised suspension it is wise to use an adjustable panhard rod to correct the axle position which will in turn maintain and restore the steering geometry.



**DA1130TUBEKIT**

90/110

Defender

Replacement panhard  
rod adaptor tubes

### Radius Arms



DA5505

- > Designed for Defender Discovery 1 Range Rover Classic with an extended 1 to 3" lift
- > Front radius arms correct castor alignment which in turn ensures safe driving
- > Rear radius arms provide full rear axle articulation
- > Fitting the radius arms will contribute to much better off-road capability for your vehicle by fully utilising your spring and shock absorber set
- > Zinc passivated with a yellow heavy-duty powder coating finish to complement each component and the Britpart coil springs

**DA5505** 3° Heavy-duty - pair Narrow - 38mm  
Use with NTC7307 & DA2353 bushes

**DA5506** 3° Heavy-duty - pair Wide - 45mm  
Use with NTC6781 & DA2353 bushes



**DA5510** 2" Lift rear radius arm Pair

### Subframe Arms & Bolt Kit



**DA3431 NEW**  
Subframe suspension arms and bolt kit  
Rear  
Freelander 2  
Range Rover Evoque - 2012 - 2018

### XS Half Axle Shafts



Rear half axle shafts with black painted flange  
Defender - 2007 - 2016  
**LR072976XS NEW**  
Right hand side  
**LR072977XS NEW**  
Left hand side

### Meyle Heavy-Duty

Steering and suspension components are subject to extremely high load levels, which frequently results in increased part wear and shorter replacement intervals. Required to perform reliably under these conditions, the parts are therefore made to genuine Meyle heavy duty quality which means optimised products offering maximum service life and outshining OE solutions.

Bushes	
<b>LR073366HD</b>	Discovery 4
Connecting Spindle Rods	
<b>QFK500020HD</b>	Discovery 3
<b>QFK500010HD</b>	Discovery 3/Discovery 4

Stabiliser Link Bars	
<b>RBM500190HD</b>	Discovery 3
<b>RGD000312HD</b>	Discovery 3/Discovery 4 Range Rover Sport
<b>LR014145HD</b>	Discovery 4
<b>LR024474HD</b>	Discovery Sport Range Rover Evoque
<b>LR002626HD</b>	Freelander 2
<b>LR002876HD</b>	Freelander 2 Range Rover Evoque
<b>LR030048HD</b>	Range Rover L322
<b>LR030047HD</b>	Range Rover L322
<b>LR073340HD</b>	Range Rover L322

Suspension Arms	
<b>LR075993HD</b>	Discovery 3
<b>LR075995HD</b>	Discovery 3
<b>LR075996HD</b>	Discovery 3
<b>LR073367HD NEW</b>	Discovery 4
<b>LR073369HD NEW</b>	Discovery 4
<b>LR029303HD</b>	Range Rover Sport - 2005 - 2009
<b>LR029304HD</b>	Range Rover Sport - 2005 - 2009
<b>LR029305HD</b>	Range Rover Sport - 2005 - 2009
<b>LR029306HD</b>	Range Rover Sport - 2005 - 2009
<b>LR029301HD</b>	Range Rover Sport - 2010 - 2013
<b>LR029302HD</b>	Range Rover Sport - 2010 - 2013

Link Assembly Anti-roll Bars	
<b>RBM100223HD</b>	Discovery 2
<b>RGD100682HD</b>	Discovery 2
<b>RBM100172HD</b>	Freelander 1
<b>ANR3304HD</b>	Range Rover P38
<b>RGD500140HD</b>	Range Rover Sport - 2002 - 2013



**RBM100223HD**

**QFK500020HD**

**LR075996HD**

**4-year guarantee for Meyle-HD!**

**LR002876HD**

**LR033238**

**Insulator**  
**LR033238 NEW**  
Discovery 5  
Range Rover L405  
Rear Cross Member & Stabiliser Bar Insulator

**LR073366HD**



**DA1710**

**Adjustable Control Arms**  
Discovery 5  
Range Rover Sport - Mk2  
Range Rover L405  
The Meyle HD control arms are designed to combine the three different camber options available from OE into one adjustable reference per side. Bushings and ball joint are designed for higher durability in comparison to OE and the control arm body is forged instead of casted for higher strength. The design deviates from the OE but the control arms are developed to replace the following OE references:

<b>DA1710</b>		<b>DA1709</b>	
Right hand side		Left hand side	
LR034211	LR113259	LR034214	LR113265
LR034212	LR113260	LR034215	LR113266
LR034213	LR113261	LR034216	LR113267
LR044841	LR113262	LR044844	LR113268
LR044842	LR113263	LR044845	LR113270
LR044843	LR113264	LR044846	LR113271
LR108765		LR108766	

OE Meyle



**Ball Joint Assembly**  
**RBK500210M NEW**  
Range Rover L322  
Front upper suspension arm ball joint assembly



Photo by Dennis Canonizado



# SUSPENSION & AXLE

## Axle

### Suspension Arms



Kits contains suspension arm, bushes and bolts where applicable.

Have all the parts you need with one easy part number when you have to change a suspension arm.

Britpart XS Kit with Lemförder bushes	Britpart XS Kit with Britpart bushes	Britpart Kit	OEM Kit	No Bushes or Bolts*			
<b>RBJ500222G</b>			<b>RBJ500222GK</b>		Discovery 3	Front - upper	RHS
<b>RBJ500232G</b>			<b>RBJ500232GK</b>		Discovery 3	Front - upper	LHS
				<b>RBJ500840NB</b>	Discovery 3 - heavy-duty	Front - upper	RHS
				<b>RBJ500850NB</b>	Discovery 3 - heavy-duty	Front - upper	LHS
<b>LR075993G</b>	<b>LR075993PY NEW</b>	<b>LR075993K</b>	<b>LR075993GK</b>	<b>LR075993NB</b>	Discovery 3	Front - lower	RHS
<b>LR075995G</b>	<b>LR075995PY NEW</b>	<b>LR075995K</b>	<b>LR075995GK</b>	<b>LR075995NB</b>	Discovery 3	Front - lower	LHS
<b>LR051622G</b>			<b>LR051622GK</b>		Discovery 3	Rear - upper	RHS
<b>LR051623G</b>			<b>LR051623GK</b>		Discovery 3	Rear - upper	LHS
<b>LR051614G</b>					Discovery 4	Rear - upper	RHS
<b>LR051615G</b>					Discovery 4	Rear - upper	LHS
				<b>RBJ500840NB</b>	Discovery 4 - heavy-duty	Front - upper	RHS
				<b>RBJ500850NB</b>	Discovery 4 - heavy-duty	Front - upper	LHS
<b>LR073367G</b>		<b>LR073367K</b>	<b>LR073367GK</b>		Discovery 4	Front - lower	RHS
<b>LR073369G</b>		<b>LR073369K</b>	<b>LR073369GK</b>		Discovery 4	Front - lower	LHS
<b>LR051622G</b>			<b>LR051622GK</b>		Discovery 4	Rear - upper	RHS
<b>LR051623G</b>			<b>LR051623GK</b>		Discovery 4	Rear - upper	LHS
<b>LR051592G NEW</b>		<b>LR051592K</b>			Discovery 4	Rear - lower	RHS
<b>LR051594G NEW</b>		<b>LR051594K</b>			Discovery 4	Rear - lower	LHS
				<b>RBJ500840NB</b>	Range Rover Sport - 2005 - 2009 - with ACE suspension	Front - upper	RHS
				<b>RBJ500850NB</b>	Range Rover Sport - 2005 - 2009 - with ACE suspension	Front - upper	LHS
<b>LR029303G</b>		<b>LR029303K</b>	<b>LR029303GK</b>		Range Rover Sport - 2005 - 2009	Front - lower	RHS
<b>LR029304G</b>		<b>LR029304K</b>	<b>LR029304GK</b>		Range Rover Sport - 2005 - 2009	Front - lower	RHS
<b>LR029305G</b>		<b>LR029305K</b>	<b>LR029305GK</b>		Range Rover Sport - 2005 - 2009	Front - lower	LHS
<b>LR029306G</b>		<b>LR029306K</b>	<b>LR029306GK</b>		Range Rover Sport - 2005 - 2009	Front - lower	LHS
<b>LR029301G</b>					Range Rover Sport - 2010 - 2013	Front - lower	RHS
<b>LR029302G</b>					Range Rover Sport - 2010 - 2013	Front - lower	LHS
<b>LR063719G</b>					Range Rover Sport - 2005 - 2013	Rear - upper	RHS
<b>LR063718G</b>					Range Rover Sport - 2005 - 2013	Rear - upper	LHS
<b>LR019977G NEW</b>					Range Rover Sport - 2010 - 2013	Rear - lower	RHS
<b>LR019978G NEW</b>					Range Rover Sport - 2010 - 2013	Rear - lower	LHS

\*Supplied with ball joint.

### Suspension Bolt Kits

**DA7202**  
Defender - up to KA930455  
Front suspension - radius arms & panhard rod bolts  
**DA7200**  
Defender - LA930456 to WA159806  
Front suspension - radius arms & panhard rod bolts  
**DA7203**  
Defender - XA159807 to 2A626645  
Front suspension - radius arms & panhard rod bolts  
**DA7204**  
Defender - 2A625546 onwards  
Front suspension - radius arms & panhard rod bolts  
**DA7201**  
Defender - up to YA185790  
Rear suspension - trailing arms & a-frame bolts  
**DA7208**  
Defender - YA185791 onwards  
Rear suspension - trailing arms & a-frame bolts  
**DA7212**  
Discovery 3/Discovery 4/Range Rover Sport - 2005 - 2012  
Front upper suspension arm Single  
**DA7205**  
Discovery 3/Discovery 4/Range Rover Sport - 2005 - 2012  
Front lower suspension arm Single  
**Note** - This kit includes a 1.5mm pitch threaded nut, please check the thread pitch on your drive shaft before changing. If you require the 2mm pitch nut please order LR024151.  
**DA7207**  
Discovery 3/Discovery 4/Range Rover Sport - 2005 - 2012  
Rear upper suspension arm Single  
**DA7206**  
Discovery 3/Discovery 4/Range Rover Sport - 2005 - 2012  
Rear lower suspension arm Single



### Heavy-Duty Axles

Defender heavy-duty axles are a straight replacement for your existing axles and offer substantial protection.

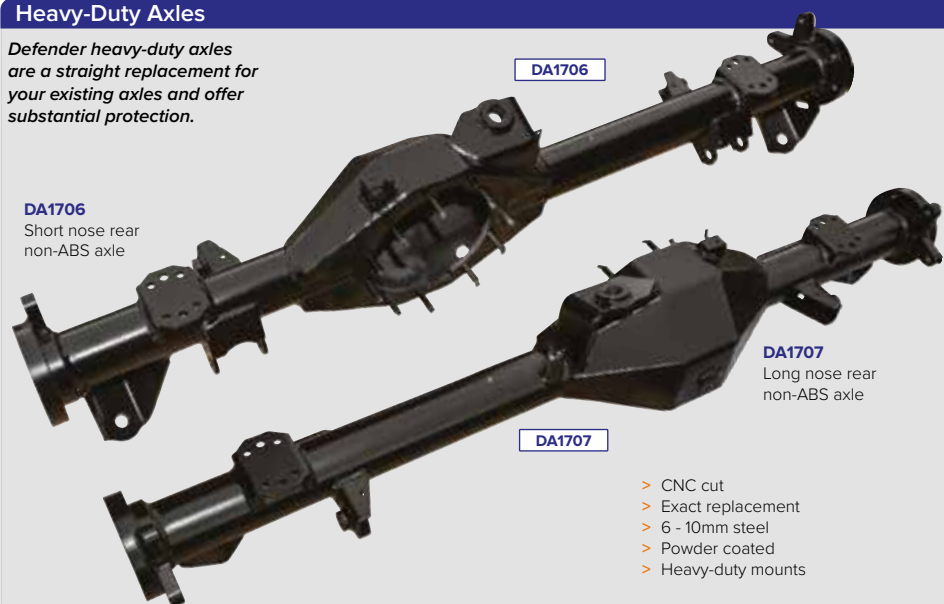

**Shock Absorber Brackets & Turrets**



**DA1186**

**Shock Turrets**

Defender/Discovery 1/Range Rover Classic  
**DA1186**

Galvanised standard height front shock turrets with fitting kit.

**NRC6372GALV**

Galvanised standard height front shock turret - single

**NRC9700GALV**

Galvanised spring seat - single



**Long Travel Rear Shock Absorber Mounting Kit DA6337**

Defender/Discovery 1/Range Rover Classic  
The standard pin and eye shock absorbers don't have the necessary articulation for extreme off-road conditions and the answer is to use pin and pin shock absorbers.

If you use our Cellular Dynamic Plus 5 shock absorbers they offer better articulation. Laser cut, jigged and computer welded with zinc plated and powder coated finish. To be used in conjunction with DC6000LL.

**Note** - On Defender Td5 the fuel filter must be moved.

**XS Skeletonised Shock Turrets**

Discovery 2

**DA3296 NEW**

Front

Standard height

Front

2" Lift

Stylish XS skeletonised shock absorber turrets. Stronger and easier to clean than the original turrets. Powder coated for a heavy-duty hard wearing finish. Complete with nuts and bolts

**DA3297**



**DA6323L**



**DA6322**



**DA6324**

Kit includes nuts, bolts & washers

Defender/Discovery 1/Range Rover Classic\*

**DA6322** Twin shock turrets Front Standard height

**DA6322L** Twin shock turrets Front 2" Lift

**DA6323** Single shock turrets Front Standard height

**DA6323L** Single shock turrets Front 2" Lift

**DA6324** Twin shock brackets - kit Rear

\***Note** - Rear brackets involve some welding to fit. Fitting shock absorber brackets may require some vehicle modification, please ask your Britpart stockist for full details.



Sometimes off-road conditions can be serious enough to test the standard equipment on your Land Rover to its maximum. One of the critical components that takes most of the abuse is the suspension system. When using the standard single shock absorber configuration it is not unknown for the shock absorber to break the factory fitted turret mount. These shock absorber turrets from Britpart give you confidence that your vehicles suspension will tackle the terrain you take it through with greater ease.

The single shock absorber turret is manufactured from heavy-duty steel and replaces the existing turret mount which is susceptible to corrosion by allowing a build up of dirt inside which is hard to clean thoroughly. The new design is harder wearing and easier to clean.

The twin shock absorber turret is manufactured from the same quality steel as the single shock absorber turret but allows for the fitting of an additional shock absorber. The benefits of having extra shock absorbers fitted to your Land Rover is that any extreme force encountered is divided between the two shock absorbers for a more comfortable ride for you and your passengers. Using twin shocks is also beneficial when carrying loads both on and off-road as it improves the load carrying ability of the vehicle. An additional benefit is that when changing shock absorbers there is no need to remove the turrets.

*Sometimes off-road conditions can be serious enough to test the standard equipment on your Land Rover...*



**DA6322L**

**DA6323**

**DA6324L**

**Adjustable Ball Joint**



**RHF500110A**

Defender/Discovery 1/Range Rover Classic  
An adjustable A-frame ball joint  
Single

**Turret Rings**



**DA6338**

Defender  
Discovery 1  
Range Rover Classic  
These robust & heavy-duty front shock absorber turret rings are made to replace the existing standard turret rings.

**Spring Retainers**



**DA2363**

**DA2362**

**DA2362** Front  
**DA2363** Rear  
Defender/Discovery 1/Range Rover Classic  
In some situations the vehicle's springs can get dislodged from their seating, these heavy-duty spring retainers ensure the springs are kept in the correct position.

**Rear Shock Droppers**



Defender/Discovery 1/Range Rover Classic  
**DA7528**  
Rear shock absorber droppers  
Pair



# SUSPENSION & AXLE

## Brackets, Mounts & Ancillary Products

### Spring Spacer Blocks



#### Defender - 90/Discovery 1/Range Rover Classic

**DA6344** Front pair  
**DA6345** Rear pair

These 50mm spring spacer blocks are manufactured from 6mm plate with a powder coated finish. The spacers fit between the axle and the spring seats on the front and rear to give you that extra 50mm of lift you need.

#### Discovery 2

These 40mm spring spacer blocks are machined from high quality aluminium and anodised deep blue.

**DA6341** Front pair  
With this kit you are able to retain the standard springs and shock absorbers. Use in conjunction with DA6342.

**DA6342** Rear pair  
This kit enables you to retain your air springs yet give your vehicle the desired 40mm lift. We recommend that this kit be fitted in conjunction with DA6341, DA4198 or DA4199. Please look at the shock absorbers suitable for this vehicle and at 40mm braided brake hoses.

### Dislocation Cones

These clever products ensure your springs relocate correctly when using your Land Rover in extreme conditions. Use in conjunction with spring retainers.



#### Stainless Steel

**DA2186**

Defender 90/Discovery 1

Rear

Pair

#### Galvanised

**DA1965**

Defender 110

Rear

Pair

### Rear Spring Seats



Galvanised rear spring seat fitting kits

**DA1215**

Defender - 90/Discovery 1/Range Rover Classic

**DA1233**

Defender - 110 & 130

**NRC9700GALV**

Galvanised spring seat - single

### Lift Rod Kit



#### DA7531

Fully adjustable suspension lift rod kit  
Discovery 3/Discovery 4/Range Rover Sport - 2005 - 2013

*"The ease of changing the ride height is what separates these rods from others in the marketplace."*

These adjustable rods replace the plastic and rubber parts Land Rover supply on the vehicle. Made from aluminium with an industrial heavy grade rubber bushing, the aluminium parts are anodised black to help with corrosion protection and blending in when in the garage for work.

The lift rods have two settings; standard and off-road. With the air suspension set to normal driving height the lengthened rods will give you standard road and off road driving heights. If you shorten the rods the standard ride height will be approx 50mm higher. If you select off-road height the vehicle will be in the 'super extended' position.

No tools are required and should take no more than 2 minutes to do all four rods.

Access to the front is over the front wheels and for the back is through the rear wishbones (blanket required!)

**Note** - If run for a long time in off-road position then wheels may need realigning.

## Bushes

### Bump Stops



Extended polyurethane bump stops should be used on vehicles with raised suspension to prevent the shock absorbers from bottoming out. All sold individually.



#### Discovery 2

Set of 4 stops

**DC7112**

Front/Rear Standard height - 60mm Black

**DC7012**

Front/Rear Standard height - 60mm Yellow

**DC7113**

Front/Rear Extended height - 90mm Black

**DC7013**

Front/Rear Extended height - 90mm Yellow

#### Defender & Discovery 1

**ANR4188PY-YELLOW**

Front Standard height - 56mm Yellow

**ANR4189PY**

Front & rear Standard height - 56mm Black

**ANR4189PY-YELLOW**

Rear Standard height - 56mm Yellow

**ANR4188EYELLOW**

Front Extended height - 80mm Yellow

**ANR4189PYE**

Front & rear Extended height - 80mm Black

**ANR4189EYELLOW**

Rear Extended height - 80mm Yellow

### Bush Sets - Britpart



#### Rubber Bush Set

Front radius arm to chassis kit  
Defender - 1987 - 1997/Discovery 1  
Range Rover Classic - 1986 - 1994

**DA2353**

**DA2353G**

Britpart

OEM

#### Polyurethane Bush Sets

**DA4035BLUE**  
Defender - 90/110/130 - up to 1993 with drum brakes

**DA4036BLUE**

Defender - 1994 onwards/Discovery 1

Range Rover Classic - 1986 onwards

**DA4035BLUE**

### Bush Sets - Powerflex

#### Discovery 3/Discovery 4/Range Rover Sport - Mk1

**LR073366PF** Front arm - lower - rear

**LR051585PF** Front arm - lower - front

> Better handling & better stability under braking

> Prolong tyre life

> High quality polyurethane material

> Last longer (up to 10 x rubber equivalent)

> Easily fitted

Powerflex bushes offer improved performance, safety and prolong tyre life. Engineered to be the best, Powerflex bushes are an answer to soft ageing and failing rubber suspension bushes and provide improved suspension mountings. No special tools are needed and comprehensive fitting instructions are included.

**LR051585PF**



### Bush Fitting Tool



**LRT-60-004**

Fitting new front radius arm bushes (part number ANR3332) for the Range Rover P38A is impossible to do without using the Land Rover special tool.

### Bush Sets - Watts Linkage



**RGX100960K**

**DA1199**

**RGX100960K**

Discovery 2  
Watts rear linkage bush set contains bushes to replace centre bearing, top & bottom bush links and axle end links.

**DA1199**

Discovery 2

This replacement pivot for the rear suspension is complete with bushes fitted which makes an awkward job easier.

### Bush Sets - Castor Correction



**DA8952**

Available in UK only

Defender/Discovery 1/Range Rover Classic Old Man Emu replacement bushes to correct the castor angle after a Land Rover has been lifted. These will ensure the correct steering geometry is maintained.

**DA8952** Wide bush - 44mm

**DA8951** Narrow bush - 38mm

### Bushes - Meyle Heavy-Duty



**LR073366HD**

Discovery 4

Steering and suspension components are subject to extremely high load levels, which frequently results in increased part wear and shorter replacement intervals. Required to perform reliably under these conditions our parts are therefore made in genuine Meyle heavy duty quality which means optimised products offering maximum service life and outshining OE solutions.

### Bush Sets - Polybush

#### Polybush Orange Dynamic Bushes

Discovery 2

**DA2204**

Full Polybush Dynamic Orange Kit  
Kit contents - Front radius arm to axle; front radius arm to chassis; front panhard rod; rear axle - watts link to chassis bush; rear radius arm to chassis; rear radius arm to axle

**ROA100040PYB**

Shock absorber - lower

Freelander 2/Discovery Sport

Range Rover Evoque

**DA8899**

Full Polybush Dynamic Orange Kit

Kit contains -

Front wishbone - front & rear bushes; rear trailing arm - inner & outer (hub end) bushes; rear forward track arm - inner & outer bushes; rear rear track arm - inner & outer bushes  
Individual Polybush Dynamic Orange Kits

**LR005649PY**

Front anti-roll bar bush kit

**LR031310PY / LR034392PY**

Rear anti-roll bar bush kit

Range Rover L322

**DA8897**

Full Polybush Dynamic Orange Kit

Kit contains - Front - front wishbone arm inner & rear wishbone arm inner; Rear - upper wishbone inner front and rear; lower wishbone inner front & lower wishbone inner rear

Discovery 5

Range Rover Sport - 2014 onwards

**DA2887 NEW**

Full Polybush Dynamic Orange Kit

Kit contains -

Front upper arm bushes; front lower rear arm inner bushes; front lower rear arm outer bushes; front lower front arm bushes & rear upper arm bushes

Range Rover L405

**DA2888 NEW**

Full Polybush Dynamic Orange Kit

Kit contains -

Front upper arm bushes; front lower rear arm inner bushes; front lower rear arm outer bushes; front lower front arm bushes & rear upper arm bushes

#### Polybush Blue Comfort Bushes

Range Rover P38 - 1994 onwards

**DA2203**

Full Polybush Blue Comfort Kit

Kit contents - Front radius arm to axle; front radius arm to chassis; panhard rod; rear radius arm to chassis

Discovery 1

Range Rover Classic - 1986 onwards

**DA2217**

Full Polybush Blue Comfort Kit

Kit contents - Front radius arm to axle; front radius arm to chassis; panhard rod; rear radius arm to axle; rear radius arm to chassis

**Lasts 4-5 times longer than rubber**



Discovery 3 & Discovery 4

**DA3144**

Full Polybush Dynamic Orange Kit

Kit contains - Front lower wishbone - front & rear bushes; front upper wishbone bushes; rear lower wishbone - front & rear bushes; rear upper wishbone - front & rear bushes  
Individual Polybush Dynamic Orange Kits

**LR015339PY**

Front anti-roll bar clamp kit

**RGX500060PY**

Rear anti-roll bar clamp kit

**LR056964PY**

Front upper wishbone kit

**LR051585PYB**

Front lower wishbone - front kit

**LR073366PYB**

Front lower wishbone - rear kit

**LR051611PY**

Rear lower wishbone - front kit

**LR054831PY**

Rear lower wishbone - rear kit

**LR051616PY**

Rear upper wishbone - rear kit

**LR051621PY**

Rear upper wishbone - front kit

**ROA000022PY**

Damper kit - front & rear

#### Polybush Red Classic Bushes

Defender/Discovery 1/Range Rover Classic

**DA2220**

Full Polybush Classic Red Kit

Suspension bush set - wide bushes

Defender 90 & 110 - 1994 onwards

Discovery 1

Range Rover Classic - 1986 onwards

Kit contains - Axle - front radius arm/rear radius arm & panhard rod. Chassis - front radius arm & rear radius arm

#### Other Polybush sets available from Britpart

Full details supplied on request.

Benefits of fitting Polybush include:

- > Easy to fit - the original fit and forget
- > Less downtime - keeping your vehicle on the road
- > Reduced MOT costs

Defender - 2020 onwards

Discovery 5

**LR174897PYB NEW**

Dynamic Orange

Front suspension arm bush kit

Defender - 2020/Discovery 5

Range Rover - L405

Range Rover Sport - Mk2

**LR148836PYB**

Dynamic Orange

Front suspension arm bush kit

Range Rover Sport - 2005 - 2013

**DA6049**

Full Polybush Dynamic Orange Kit

Kit contains - Front lower wishbone - front & rear bushes; front upper wishbone bushes; rear lower wishbone - front & rear bushes; rear upper wishbone - front & rear bushes

Range Rover Sport - 2010 - 2013

**RVU500011PY**

Front anti-roll bar bush with ACE - pair

**RVU000022PY**

Rear anti-roll bar bush with ACE - pair

Defender - 2002 onwards

**DA2198**

Full Polybush Classic Red Kit

Kit contents - Front radius arm/axle; front radius arm/chassis; panhard rod; rear radius arm/axle; rear radius arm/chassis

Defender - 1987 - 2006 & 2007 onwards

Discovery 1

Range Rover Classic - 1986 - 1994

**NTC1773PB**

Polybush Classic Red Kit

Rear suspension - upper link bush

- > Lasts 4-5 times longer than rubber
- > Controlled suspension movement
- > Impressive & confident ride
- > Prolonged tyre life
- > Unaffected by oil, fuel and road contaminants
- > Fixes premature bush failures
- > No requirement for specialist tools

*Polybush's use of high quality pure materials offers immense flexibility and resilience, providing original ride comfort with the durability of Polyurethane.*

*All of their bushes are designed and engineered to exact specification. Keeping suspension working as the manufacturer intended.*



Photo by Antony Lee



# SUSPENSION & AXLE

## Bushes

### Bushes - Britpart Individual Polyurethane Sets

<b>Defender</b>	
<b>ANR3410PY</b>	Panhard rod
<b>ANR3410PY-YELLOW</b>	Panhard rod
<b>ANR4164PY</b>	Rear upper link
<b>ANR4164PY-YELLOW</b>	Rear upper link
<b>EGP1889PY</b>	Rear anti-roll bar
<b>NRC4514PY</b>	Radius arm to chassis
<b>NRC4514PY-YELLOW</b>	Radius arm to chassis
<b>NRC5593PY</b>	Damper mounting
<b>NRC5593PY-YELLOW</b>	Damper mounting
<b>NTC1772PY</b>	Lower arm
<b>NTC1772PY-YELLOW</b>	Lower arm
<b>NTC1773PY</b>	Upper link
<b>NTC1773PY-YELLOW</b>	Upper link
<b>NTC6781PY</b>	Radius arm to axle
<b>NTC6781PY-YELLOW</b>	Radius arm to axle
<b>NTC6828PY</b>	Anti-roll bar
<b>NTC6828PY-YELLOW</b>	Anti-roll bar
<b>NTC7307PY</b>	Radius arm to axle
<b>NTC7307PY-YELLOW</b>	Radius arm to axle
<b>NTC7394PY</b>	Anti-roll bar
<b>NTC7394PY-YELLOW</b>	Anti-roll bar
<b>QEM500020PY</b>	Steering damper
<b>QEM500020PY-YELLOW</b>	Steering damper
<b>RBX101340PY</b>	Panhard rod
<b>RBX101340PY-YELLOW</b>	Panhard rod
<b>RBX101690PY</b>	Anti-roll bar
<b>RBX101690PY-YELLOW</b>	Anti-roll bar
<b>STC618PY</b>	Mounting lower link
<b>STC618PY-YELLOW</b>	Mounting lower link

<b>Discovery 1</b>	
<b>ANR1721PY</b>	Damper mounting
<b>ANR1721PY-YELLOW</b>	Damper mounting
<b>ANR3410PY</b>	Panhard rod
<b>ANR3410PY-YELLOW</b>	Panhard rod
<b>NRC4514PY</b>	Radius arm to chassis
<b>NRC4514PY-YELLOW</b>	Radius arm to chassis
<b>NRC5593PY</b>	Damper mounting
<b>NRC5593PY-YELLOW</b>	Damper mounting
<b>NTC1772PY</b>	Lower arm
<b>NTC1772PY-YELLOW</b>	Lower arm
<b>NTC1773PY</b>	Upper link
<b>NTC1773PY-YELLOW</b>	Upper link
<b>NTC6828PY</b>	Anti-roll bar
<b>NTC6828PY-YELLOW</b>	Anti-roll bar
<b>NTC6860PY</b>	Radius arm to axle
<b>NTC6860PY-YELLOW</b>	Radius arm to axle
<b>NTC7394PY</b>	Anti-roll bar
<b>NTC7394PY-YELLOW</b>	Anti-roll bar
<b>STC618PY</b>	Mounting lower link
<b>STC618PY-YELLOW</b>	Mounting lower link

<b>Discovery 2</b>	
<b>ANR6947PY</b>	Radius arm to axle
<b>ANR6947PY-YELLOW</b>	Radius arm to axle
<b>RBX101340PY</b>	Panhard rod
<b>RBX101340PY-YELLOW</b>	Panhard rod
<b>RBX101680PY</b>	Radius arm to axle
<b>RBX101680PY-YELLOW</b>	Radius arm to axle
<b>RBX101690PY</b>	Anti-roll bar
<b>RBX101690PY-YELLOW</b>	Anti-roll bar
<b>RBX101730PY</b>	Radius arm to chassis
<b>RBX101730PY-YELLOW</b>	Radius arm to chassis
<b>RGX100970PY</b>	Transverse link
<b>RGX100970PY-YELLOW</b>	Transverse link
<b>ROA100050PY</b>	Shock absorber - upper

<b>Discovery 4 - Red Bushes</b>	
<b>LR051585PY</b>	Front suspension arm - lower front
<b>LR073366PY</b>	Front suspension arm - lower rear

<b>Range Rover Classic</b>	
<b>572068PY</b>	Radius arm to chassis - outer
<b>572068PY-YELLOW</b>	Radius arm to chassis - outer
<b>572180PY</b>	Bottom link to chassis
<b>572180PY-YELLOW</b>	Bottom link to chassis
<b>575580PY</b>	Panhard rod
<b>575580PY-YELLOW</b>	Panhard rod
<b>ANR1721PY</b>	Damper mounting
<b>ANR1721PY-YELLOW</b>	Damper mounting
<b>ANR3410PY</b>	Panhard rod
<b>ANR3410PY-YELLOW</b>	Panhard rod
<b>NRC4514PY</b>	Radius arm to chassis
<b>NRC4514PY-YELLOW</b>	Radius arm to chassis
<b>NRC5593PY</b>	Damper mounting
<b>NRC5593PY-YELLOW</b>	Damper mounting
<b>NTC1772PY</b>	Lower arm
<b>NTC1772PY-YELLOW</b>	Lower arm
<b>NTC1773PY</b>	Upper link
<b>NTC1773PY-YELLOW</b>	Upper link
<b>NTC6781PY</b>	Radius arm to axle
<b>NTC6781PY-YELLOW</b>	Radius arm to axle
<b>NTC6828PY</b>	Anti-roll bar
<b>NTC6828PY-YELLOW</b>	Anti-roll bar
<b>NTC6860PY</b>	Radius arm to axle
<b>NTC6860PY-YELLOW</b>	Radius arm to axle
<b>NTC7394PY</b>	Anti-roll bar
<b>NTC7394PY-YELLOW</b>	Anti-roll bar
<b>RNF100090PY</b>	Shock absorber - lower
<b>RNF100090PY-YELLOW</b>	Shock absorber - lower
<b>STC618PY</b>	Mounting lower link
<b>STC618PY-YELLOW</b>	Mounting lower link

<b>Range Rover P38</b>	
<b>ANR2563PY</b>	Radius arm to chassis
<b>ANR2563PY-YELLOW</b>	Radius arm to chassis
<b>ANR3285PY</b>	Trailing arm rear suspension
<b>ANR3285PY-YELLOW</b>	Trailing arm rear suspension
<b>ANR3305PY</b>	Anti-roll bar
<b>ANR3305PY-YELLOW</b>	Anti-roll bar
<b>ANR3332PY</b>	Radius arm to axle
<b>ANR3332PY-YELLOW</b>	Radius arm to axle
<b>RNF100090PY</b>	Shock absorber - lower
<b>RNF100090PY-YELLOW</b>	Shock absorber - lower

**Note** - Part numbers without yellow as a suffix indicate the bush colour is black.



All bushes are manufactured using the latest Vulkollan™ polyurethane technology.



<b>Freelander 1</b>	
<b>RBX101240PY</b>	Anti-roll bar
<b>RBX101240PY-YELLOW</b>	Anti-roll bar
<b>RBX101780PY</b>	Lower arm
<b>RBX101780PY-YELLOW</b>	Lower arm
<b>RBX101790PY</b>	Lower arm
<b>RBX101790PY-YELLOW</b>	Lower arm
<b>RDB100080PY</b>	Lower arm control buffer
<b>RDB100080PY-YELLOW</b>	Lower arm control buffer
<b>RGX101000PY</b>	Trailing link
<b>RGX101000PY-YELLOW</b>	Trailing link
<b>RGX101010PY</b>	Hub
<b>RGX101010PY-YELLOW</b>	Hub
<b>RGX101020PY</b>	Bottom link - outer
<b>RGX101020PY-YELLOW</b>	Bottom link - outer
<b>RGX101440PY</b>	Bottom link - inner
<b>RGX101440PY-YELLOW</b>	Bottom link - inner

Machined to exact tolerances once cast to produce the highest finish available

<b>Series</b>	
<b>548205PY</b>	Shackle & spring
<b>548205PY-YELLOW</b>	Shackle & spring
<b>552818PY</b>	Shock absorber
<b>552818PY-YELLOW</b>	Shock absorber
<b>552819PY</b>	Shock absorber
<b>552819PY-YELLOW</b>	Shock absorber
<b>568858PY</b>	Steering damper
<b>568858PY-YELLOW</b>	Steering damper
<b>569746PY</b>	Rear chassis
<b>569746PY-YELLOW</b>	Rear chassis
<b>90577434PY</b>	Rear chassis
<b>90577434PY-YELLOW</b>	Rear chassis

- > Britpart are proud to present an exclusive range of Yellow and Black polyurethane bushes
- > Manufactured exclusively for Britpart using the latest Vulkollan™ polyurethane technology
- > Machined to exact tolerances once cast to produce the highest finish available
- > Produced in both yellow and black they are both the same compound which gives similar ride characteristics to the standard rubber bushes, but they offer improved articulation, vibration damping and last longer
- > The black bushes are ideal for replacing individual bushes as they can be fitted without a press
- > The DC range of kits include shock absorber and A-frame bushes



### Bushes - Britpart Polyurethane Sets



#### Britpart Yellow Suspension Bush Sets

<b>DC7003</b>	Series 1, 2 & 3 - excluding 3 LWB (see DC7004)
<b>DC7004</b>	Series 3 - LWB
<b>DC7009</b>	Defender - up to 1993
<b>DC7010</b>	Defender - 1994 - 1999
<b>DC7008</b>	Defender - 1999 - 2007
<b>DC7011</b>	Defender - 2007 onwards - up to 9A766382
<b>DC7014</b>	Defender - 2007 onwards - from 9A7689367
<b>DA2425</b>	Defender - steering damper bush set
<b>DC7000</b>	Discovery 1
<b>DC7001</b>	Discovery 2*/**
<b>DC7002</b>	Freelander 1
<b>DC7005</b>	Range Rover Classic - up to 1986
<b>DC7006</b>	Range Rover Classic - 1986 - 1994
<b>DC7007</b>	Range Rover P38**

All bushes are manufactured using the latest **Vulkollan™** polyurethane technology.

#### Britpart Black Suspension Bush Sets

<b>DC7103</b>	Series 1, 2 & 3 - excluding 3 LWB (see DC7104)
<b>DC7104</b>	Series 3 - LWB
<b>DC7109</b>	Defender - up to 1993
<b>DC7110</b>	Defender - 1994 - 1999
<b>DC7108</b>	Defender - 1999 - 2007
<b>DC7111</b>	Defender - 2007 onwards - up to 9A766382
<b>DC7114</b>	Defender - 2007 onwards - from 9A7689367
<b>DA2426</b>	Defender - steering damper bush set
<b>DC7100</b>	Discovery 1
<b>DC7101</b>	Discovery 2*/**
<b>DC7102</b>	Freelander 1
<b>DC7105</b>	Range Rover Classic - up to 1986
<b>DC7106</b>	Range Rover Classic - 1986 - 1994
<b>DC7107</b>	Range Rover P38**

- > Britpart are proud to present an exclusive range of Yellow and Black polyurethane bushes
- > Manufactured exclusively for Britpart using the latest Vulkollan™ polyurethane technology
- > Machined to exact tolerances once cast to produce the highest finish available

> Produced in both yellow and black they are both the same compound which gives similar ride characteristics to the standard rubber bushes, but they offer improved articulation, vibration damping and last longer

> The black bushes are ideal for replacing individual bushes as they can be fitted without a press

> The DC range of kits include shock absorber and A-frame bushes

#### Notes

\*Kit includes front anti-roll bar bushes but these bushes aren't suitable for vehicles with ACE fitted.

\*\*Excludes shock absorber bushes.



### Radius Arm & Panhard Rod Bush Kits



Front bush kits include bushes for radius arms and panhard rods. Rear bush kits include bushes for top & bottom links.

#### Front Bush Kits

<b>DA1242</b>	Range Rover Classic - up to 1985
<b>DA1244</b>	Defender - up to KA
<b>DA1244G</b>	Defender - up to KA <span style="float: right;">OEM</span>
<b>DA1245</b>	Defender - from LA up to VA130784/Discovery 1
	Range Rover Classic - from 1986 onwards
<b>DA1245G</b>	Defender - from LA up to VA130784 <span style="float: right;">OEM</span>
	Discovery 1
	Range Rover Classic - from 1986 onwards
<b>DA1246</b>	Defender - from VA130785 up to 2A626645
<b>DA1247</b>	Defender - from 2A626646 onwards

#### Rear Bush Kits

<b>DA1243</b>	Range Rover Classic - up to 1985
<b>DA1248</b>	Defender to 9A768936/Discovery 1
	Range Rover Classic from 1986 on
<b>DA1248G</b>	Defender to 9A768936/Discovery 1 <span style="float: right;">OEM</span>
	Range Rover Classic from 1986 on
<b>DA1249</b>	Defender from 9A768937



# SUSPENSION & AXLE

## Air Suspension Compressors

### Hitachi Compressors

- DA3965**  
Complete Hitachi compressor kit  
Discovery 3 - up to 9A513325  
Range Rover Sport - up to 9A215622  
LR023964 - compressor & relay  
RQU500064 - compressor bracket  
DA3964 - compressor pipe/install kit  
Plus - bolts, nuts, clips & mounting rubbers
- LR023964**  
Hitachi compressor & relay  
Discovery 3 - up to 9A513325  
Range Rover Sport - up to 9A215622
- LR023964G**  
Hitachi compressor & genuine Land Rover relay  
Discovery 3 - up to 9A513325  
Range Rover Sport - up to 9A215622
- LR025111**  
Hitachi compressor & relay  
Range Rover L322 - from 6A198058 up to CA393639
- DA3964**  
Hitachi compressor pipe/install kit



*No need to reprogram the air suspension ECU*

At last, a cost effective and easy way to replace the OE air suspension compressor. These compressors are a direct replacement fit for the OE compressors that were fitted by the factory. They are made in Japan by Hitachi. By using the original brackets and pipes they are easy to install. The relay, which is included, must be changed. No need to reprogram the ECU (fault codes may need to be cleared).

- > Direct replacement fit
- > Cost effective
- > No need to reprogram the air suspension ECU
- > Uses all original mounting & pipework

### AMK Compressors

Direct replacement AMK compressors for all non-Hitachi vehicles. Manufactured by the OE company in Germany. The relay, which is included, must be changed.

- Discovery 3/Discovery 4**  
**Range Rover Sport - Mk1**  
**LR072537**  
AMK compressor, compressor covers, relay, bracket, wiring & fixings
- LR078650**  
AMK compressor, relay, bracket & fixings
- LR044034**  
Bracket only
- DA1888**  
AMK compressor pipe/install kit
- Discovery 4**  
**Range Rover Sport - Mk1 - 2010 - 2013**  
**LR038148G**  
AMK compressor, relay
- Range Rover L322**  
**LR041777C**  
AMK compressor & relay  
**Note** - Only compatible with factory fitted AMK units.
- LR041777G**  
AMK full compressor kit & relay
- Range Rover Sport - Mk2**  
**Range Rover L405**  
**LR088859G**  
AMK compressor, relay & filter
- LR108984G**  
AMK compressor, relay, filter, bracket, covers & wires
- Defender - 2020 onwards**  
**Discovery 5**  
**Range Rover Velar**  
**Range Rover Sport - 2014**  
**Range Rover - 2013**  
**LR140034G NEW**  
AMK compressor

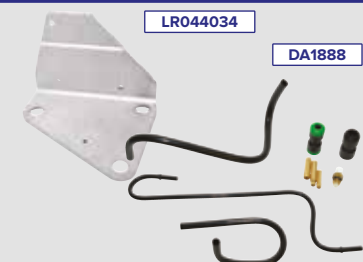

Photo by Jake Lloyd



**Britpart XD Remote Reservoir Shock Absorbers**

Britpart have developed this range of remote reservoir shock absorbers for users wanting the extra benefits of a remote reservoir shock absorber on a vehicle that is used both on and off-road. The remote reservoir allows the shock to remain cooler under more extreme conditions and hence reduces the possibility of fade. Unlike most remote reservoir shock absorbers on the market the Britpart XD remote reservoir shock absorbers use conventional rubber bushings instead of ball joints. This is because ball joints have a very short life span when used on a road vehicle and are more suited to an all out competition vehicle.

Nitrogen filled remote reservoir shock absorbers with zinc plated steel body and anodised fittings.

**Note** - Will require extra fabrication to fit.

Defender 90 & 110/Discovery 1/Range Rover Classic

Body diameter - 51mm

Shaft diameter - 20mm

Hydraulic hose length - 600mm

		Open length	Closed length
<b>DC8000</b>	Front pair	716mm	462mm
<b>DC8001</b>	Rear pair	717mm	463mm

**DA6323XD**



**DA6323XD**  
Front shock absorber turrets for use with the Britpart XD Remote Reservoir Shock Absorbers



**BRITPART XD**

**DC8000**



**DC8001**



Photo by Michael Donatin



# SUSPENSION & AXLE

## Shock Absorbers

### Britpart Cellular Dynamic Shock Absorbers

	Application	Lift	Fitment	Open/Closed Dimensions**
DC6012	Series - SWB/LWB	Long travel	Front	460/305mm
DC6013	Series - SWB	Long travel	Rear	580/360mm
DC6014	Series - LWB	Long travel	Rear	570/355mm
DC6000	Defender/Discovery 1/Range Rover Classic		Front	600/380mm
DC6001	Defender/Discovery 1/Range Rover Classic		Rear	590/375mm
DC6000L	Defender/Discovery 1/Range Rover Classic	50mm/2"	Front	665/425mm
DC6001L	Defender/Discovery 1/Range Rover Classic	50mm/2"	Rear	625/385mm
DC6000LL	Defender/Discovery 1/Range Rover Classic	125mm/5" (see note***)	Front	765/455mm
DC6001LL	Defender/Discovery 1/Range Rover Classic	125mm/5" (see note***)	Rear	750/440mm
DC6010	Discovery 2		Front	590/370mm
DC6011	Discovery 2		Rear	585/365mm
DC6002	Range Rover P38 - air suspension		Front	560/365mm
DC6003	Range Rover P38 - air suspension		Rear	505/340mm
DC6004	Defender		Steering damper	
DC6005	Discovery 1/Range Rover Classic/Series		Steering damper	
DC6009	Discovery 2		Steering damper	
DC6006	Range Rover P38		Steering damper	
DC6007	Replacement gaiter for DC6000LL & DC6001LL - single			

- > Cellular technology tube
- > Sintered 18mm rod
- > Piston diameter 41mm
- > Polyurethane bush
- > Teflon piston with multi-lip seal
- > Single piece eye ring

The Britpart Cellular Dynamic Shock Absorber represents a significant advance in Land Rover suspension systems. It features a cellular foam insert instead of a normal nitrogen gas or air, this is to stop the oil from boiling. The foam takes up less room which means more room for oil, 50% more, which offers maximum heat dispersion. This heat dispersion translates to a very subtle but controlled ride that will not fade no matter how hard you push them. They are ideal for a driver who needs more control to complement performance improvements or to enhance a standard vehicle. The unique design ensures ride comfort and cornering ability is maximised and of course they are superb off-road.

**Notes** - \*Terms & conditions apply. \*\* Dimensions are +/- 5mm. \*\*\* The Plus 5" Cellular Dynamic Shock Absorbers are specialist suspension products and to install them additional fabrication work or brackets may be required. Please ensure that they are fitted by a competent expert.



DC6001LL



*“They are ideal for a driver who needs more control to complement performance improvements”*

### Britpart Super Gaz Shock Absorbers

Britpart Super Gaz Shock Absorbers offer a 35mm bore tube filled with Fuchs shock absorber fluid, using the best seal available, single piece eye rings, polyurethane bush mounts and a very durable powder coated finish. These offer a vast improvement in ride quality and damping performance. They are ideal for use with either the Britpart Yellow Spring range or standard Land Rover springs.

**Notes** - \*Terms & conditions apply. \*\* Dimensions are +/- 5mm.

*“Vast improvement in ride quality & damping performance”*



**24 month/  
50,000 mile  
Warranty\***  
on all shock absorbers

	Application	Lift	Fitment	Open/Closed Dimensions**
DC5002	Defender/Discovery 1/Range Rover Classic		Front	605/385mm
DC5003	Defender/Discovery 1/Range Rover Classic		Rear	590/375mm
DC5002L	Defender/Discovery 1/Range Rover Classic	50mm/2"	Front	655/405mm
DC5003L	Defender/Discovery 1/Range Rover Classic	50mm/2"	Rear	640/400mm
DC5000	Discovery 2		Front	590/370mm
DC5001	Discovery 2		Rear	585/365mm
DC5000L	Discovery 2	50mm/2"	Front	640/400mm
DC5001L	Discovery 2	50mm/2"	Rear	635/390mm
DC5004	Defender		Steering damper	
DC5005	Discovery 1/Range Rover Classic/Series		Steering damper	



### Old Man Emu Shock Absorbers

	Application	Fitment	Open/Closed Dimensions
<b>N78 NEW</b>	Series 1 (86", 88", 107", 109") Front Series 2, 2A & 3 (88")	Front	447/287mm
<b>DA8911</b>	Defender - 90, 110 & 130	Front	553/329mm
<b>DA8921</b>	Defender - 90 & 110	Rear	560/346mm
<b>DA8913</b>	Defender - 90 & 110	Rear - heavy-duty	560/346mm
<b>60147</b>	Defender - 110 & 130	Rear - high articulation only - heavy loads	530/320mm
<b>60146</b>	Defender - 110 & 130	Rear - high articulation only - light loads	530/320mm
<b>FK64</b>	Defender - 110 & 130	Rear upper shock mount for 60146 & 60147	
<b>DA8913</b>	Defender - 130	Rear	560/346mm
<b>DA8911</b>	Discovery 1	Front	553/329mm
<b>DA8921</b>	Discovery 1	Rear	560/346mm
<b>DA8913</b>	Discovery 1	Rear - heavy-duty	560/346mm
<b>DA8916</b>	Discovery 2	Front	587/368mm
<b>60024L</b>	Discovery 2	Front - high articulation	627/388mm
<b>DA8917</b>	Discovery 2	Rear	587/368mm
<b>60026</b>	Discovery 2	Rear - medium load	593/368mm
<b>DA8911</b>	Range Rover Classic	Front	553/329mm
<b>DA8921</b>	Range Rover Classic	Rear	560/346mm
<b>DA8913</b>	Range Rover Classic	Rear - heavy-duty	560/346mm

Nitrocharger Sport shock absorbers introduces advanced dual-stack deflective disc technology that continuously adapts to the terrain, offering rapid response improvements to ride quality, handling and control. Available in the UK only.

#### Features

- > Interactive, multi-stacked rebound and compression valving systems ensure optimal damping performance in all conditions.
- > Vehicle specific fine tuning for superior handling and ride performance.
- > Piston rod 'slip ring' provides more consistent and uniform damping performance.
- > Triple lipped oil seal with gas retention check valve design virtually eliminates contaminant damage and gas loss.

#### Old Man Emu BP-51 High Performance Long Travel Bypass Shock Absorbers

Defender - 110 - up to 2007  
Defender - 130 - up to 2007

**Note** - Excludes high capacity pick up

<b>BP5160045</b>	Front shock absorber - single
<b>VM80010036</b>	Front fitting kit
<b>BP5160036</b>	Rear shock absorber - single
<b>VM80010037</b>	Rear fitting kit

- > BP-51 shock absorbers feature revolutionary technology developed to deliver unparalleled on and off-road performance for your Land Rover
- > Developed and tested under the harshest conditions in Australia
- > Designed to bolt onto your vehicle without any vehicle modifications
- > Considerable ride comfort around town is combined with significant end-zone damping for exceptional control and handling off-road
- > Easily adjustable damping performance across both rebound and compress

#### Vehicle Specific Applications

- > No fitting modifications are needed
- > Fit kits developed specifically for the Defender
- > All reservoir brackets have been integrated into the geometry of the Defender 110/130
- > Included in the front fit kit is a replacement front shock turret, front sway spacers, front bump stop spacers and reservoir mount assembly
- > Included in the rear fit kit is a replacement rear upper shock mount, rear sway spacers, rear bump stop spacers and reservoir mount assembly
- > Spring selection must be from the current OME Defender long travel application

More information is available on the Britpart website.

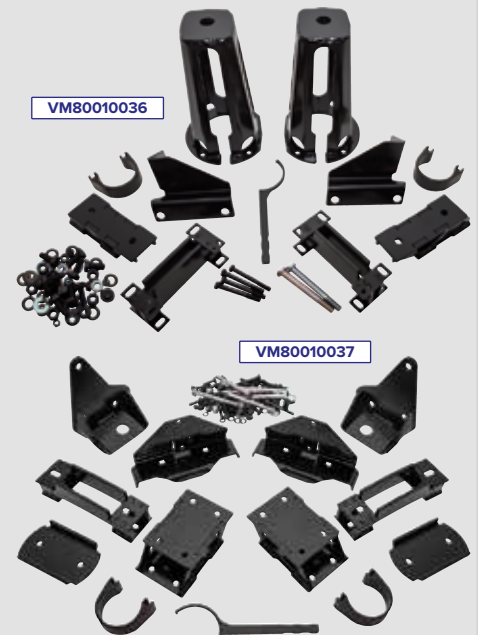

#### Replacement Old Man Emu Shock Absorber Bushes

<b>DA6803</b>	Upper mount bush for DA8916 & DA8917
<b>DA6804</b>	Lower mount bush for DA8917
<b>DA6805</b>	Lower mount bush for DA8916
<b>DA6805</b>	Upper & lower mount bush kit for DA8911
<b>DA6806</b>	Lower mount bush kit for DA8913 & DA8921



- > Impact resistant polymer dirt shield
- > Balanced, 35mm Teflon banded piston assembly
- > Teflon coated low friction glacier piston rod guide
- > 18-25mm induction hardened chrome piston rod
- > High quality replacement mounting bushes
- > Australian made & engineered

*Rapid response improvements to ride quality*



Photo by Craig Hogg

### Boge Shock Absorbers



BOGE shock absorbers offer customers great quality! The technical characteristics are exactly tailored to the vehicle specifications and will contribute to a noticeable improvement in the handling of the vehicle. High quality materials and sophisticated manufacturing processes guarantee the best quality and comfort for your vehicle.

<b>STC3766B</b>	Defender - from VA998900 to WA159806	90	Front
<b>RSC100040B</b>	Defender - XA159807 onwards	90	Front
<b>RPM100070B</b>	Defender - XA159807 onwards	90	Rear
<b>STC3941B</b>	Defender - up to GA417084	90	Rear
<b>STC3769B</b>	Defender - from VA998900 to WA159806	110/130	Front
<b>RSC100050B</b>	Defender - XA159807 onwards	110/130	Front
<b>RPM100080B</b>	Defender - XA159807 onwards	110/130	Rear
<b>STC3941B</b>	Defender - up to GA417084	110/130	Rear
<b>STC3703B</b>	Discovery 1		Front
<b>STC3941B</b>	Discovery 1		Rear
<b>STC3704B</b>	Discovery 1 - MA1359578 onwards		Rear
<b>STC2830B</b>	Range Rover Classic - MA660164 onwards - with air suspension		Front
<b>STC3941B</b>	Range Rover Classic - up to GA417084		Rear





# SUSPENSION & AXLE

## Shock Absorbers

### Britpart Heavy-Duty Shock Absorbers

Heavy-duty oil filled shock absorbers		
DA4211	Defender 90/110	Front
DA4210	Defender 90/110	Rear
RTC4234	Series 2/2A/3 - SWB	Front
RTC4235	Series 2/2A/3 - SWB	Rear
RTC4484	Series 2/2A/3 - LWB	Front
RTC4236	Series 2/2A/3 - LWB	Rear



DA4210

RTC4236



RTC4235

### Monroe Shock Absorbers



Gas filled and supplied in pairs.

STC3671M	Range Rover P38 - 1994 - 2001	Rear
RPD500940M	Range Rover L322	Rear

### Stainless Steel Shock Absorber Washers



**DA4788**  
 Defender  
 Discovery 1  
 Range Rover Classic  
 Set of 4. Stainless steel top of rear chassis shock mount washers. CNC machined from 316 stainless steel. Equivalent to RYF500210 & RYF500220.

### Bilstein Shock Absorbers



LR023573

Discovery Sport - Less magnetic damping			
LR116116G NEW		RHS	Front
LR116119G NEW		LHS	Front
LR098141G NEW			Rear
Range Rover Evoque			
LR024442B		RHS	Front
LR070934B		LHS	Front
LR070942B		RHS	Rear
LR044681B		LHS	Rear
Range Rover Sport - 2014 onwards			
LR087082B NEW		RHS	Front
LR087093B NEW		LHS	Front
Range Rover L322			
LR032567 NEW	2010 - 2012	LHS	Front
LR023573	2010 - 2012 - from BA334343		RHS
			Rear - complete assembly
LR023580 NEW	2010 - 2012 - from BA334343		LHS
			Rear - complete assembly
RPD500260G	2002 - 2009		Rear
	4.4 V8 petrol & 3.0 diesel - from 6A000001 to 7A249757		
RPD500940G NEW	2002 - 2012		Rear
	4.4 V8 & 4.2 V8 Supercharged - from 7A249758		
RPD500760G NEW			Damper only
	2002 - 2012 - 3.6 V8 diesel - from 7A000001		
Range Rover L405			
LR079515B NEW	3.0 V6 & 5.0V8		Front

### Girling Classic Shock Absorbers

RTC4230GIRLING	Series 1 - 1954-1958, Series 2, Series 2A & Series 3 - Short wheel base	Front
RTC4483GIRLING	Series 2, Series 2A & Series 3 - Long wheel base	Front
RTC4484GIRLING	Series 3 with heavy-duty suspension - Long wheel base	Front
RTC4232GIRLING	Series 1, Series 2, Series 2A & Series 3 - Short wheel base	Rear
RTC4442GIRLING	Series 2, Series 2A & Series 3 - Long wheel base	Rear
STC3766GIRLING	Defender 90 - up to WA159806	Front
STC3769GIRLING	Defender 110 & 130 - up to WA15906	Front
STC3767GIRLING	Defender 90 - up to XA159806	Rear
STC3770GIRLING	Defender 110 with self levelling suspension - up to WA159806	Rear
STC3771GIRLING	Defender 110 with normal duty suspension less self levelling suspension - up to WA159806	Rear
STC3772GIRLING	Defender 110 with heavy-duty suspension less self levelling suspension - up to WA159806	Rear
	Defender 130 - up to WA159806	

STC3703GIRLING	Discovery 1	Front
STC3941GIRLING	Discovery 1 - up to HA472849	Rear
STC3939GIRLING	Discovery 1 - up to LA081991	Rear
STC3704GIRLING	Discovery 1 - from MA081992	Rear
STC2829GIRLING	Range Rover Classic - from MA660164	Front
STC3941GIRLING	Range Rover Classic - up to GA417084	Rear
STC2831GIRLING	Range Rover Classic from MA660164	Rear
STC3672GIRLING	Range Rover P38 with air suspension - from VA348054	Front
STC3671GIRLING	Range Rover P38 with air suspension - from VA348054	Rear
Steering Damper		
RTC4472GIRLING NEW	Defender - 1987 - 2016	



RTC4442GIRLING

RTC4230GIRLING

RTC4232GIRLING



These traditional hydraulic shock absorbers come with fluid and seal technology designed to keep your Land Rover suspension under control.

Britpart Coil Springs - Lifted Springs

Britpart performance springs are high quality, versatile and competitively priced - the right choice when replacing the old sagging original springs.

Developed by one of the world's top spring manufacturers these high quality, powder coated yellow springs have been designed with the needs of today's Land Rover owners in mind. Britpart performance lifted springs have the added benefit of improving your vehicles approach and departure angles which in turn allows you to overcome more obstacles when off-roading.

As Land Rovers are often working vehicles as well as the family car, uprated springs must offer the ability to carry loads, handle off-road terrain and provide a good ride on road. The progressive springs offer a compliant ride when lightly loaded, but firm up as the load increases.

**Note** - Supplied in pairs.

			Lift	Load	Bar Diameter	Rate lbs/in	Free Height
<b>Defender</b>							
<b>DA4201</b>	Defender 90/110	Front	25mm	25kg	16mm	200	420mm
<b>DA4202</b>	Defender 90/110/130	Front	40mm	50kg	16mm	230	390mm
<b>DA4203</b>	Defender 90	Rear	40mm	Light	17mm	220	435mm
<b>DA4204</b>	Defender 90	Rear	50mm	100kg	18mm	300 - 340	425mm
<b>DA4205</b>	Defender 90	Rear	50mm	200kg	19mm	360	430mm
<b>DA4206</b>	Defender 110	Rear	40mm	100kg	17mm	270 - 295	445mm
<b>DA4208</b>	Defender 110/130	Rear	50mm	500kg	21mm	420	445mm
<b>Discovery</b>							
<b>DA4201</b>	Discovery 1	Front	25mm	25kg	16mm	200	420mm
<b>DA4202</b>	Discovery 1	Front	40mm	50kg	16mm	230	390mm
<b>DA4199</b>	Discovery 2	Front	40mm	20 - 50kg	15mm	180	390mm
<b>DA4198</b>	Discovery 2	Front	40mm	50 - 100kg	16mm	220	390mm
<b>DA4203</b>	Discovery 1/Discovery 2	Rear	40mm	Light	17mm	220	435mm
<b>DA4197</b>	Discovery 2	Rear	40mm	Medium	18mm	290	430mm
<b>DA4204</b>	Discovery 1	Rear	50mm	100kg	18mm	300 - 340	425mm
<b>DA4205</b>	Discovery 1/Discovery 2	Rear	50mm	200kg	19mm	360	430mm
<b>Range Rover</b>							
<b>DA4201</b>	Range Rover Classic	Front	25mm	25kg	16mm	200	420mm
<b>DA4202</b>	Range Rover Classic	Front	40mm	50kg	16mm	230	390mm
<b>DA4203</b>	Range Rover Classic	Rear	40mm	Light	17mm	220	435mm
<b>DA4204</b>	Range Rover Classic	Rear	50mm	100kg	18mm	300 - 340	425mm
<b>DA4205</b>	Range Rover Classic	Rear	50mm	200kg	19mm	360	430mm

Britpart Coil Springs - Standard Height Springs

Britpart yellow springs are designed for the enthusiast who wants a performance spring without having to raise the vehicle. They offer a firmer ride with less body roll, ideal for a vehicle with uprated performance or one used for carrying heavy loads. The springs are designed to offer full articulation off-road with a compliant ride. Developed by one of the world's top spring manufacturers these high quality, powder coated yellow springs have been designed with the needs of today's Land Rover owners in mind.

**Note** - Supplied in pairs.

					Bar Diameter	Rate lbs/in	Free Height
<b>Defender</b>							
<b>DA4277</b>	Defender 90/110	Front			16mm	225	390mm
<b>DA4278</b>	Defender 90	Rear			18mm	285	385mm
<b>DA4279</b>	Defender 110	Rear			19mm	330	415mm
<b>Discovery</b>							
<b>DA4277</b>	Discovery 1	Front			16mm	225	390mm
<b>DA4278</b>	Discovery 1	Rear			18mm	285	385mm
<b>Range Rover</b>							
<b>DA4277</b>	Range Rover Classic	Front			16mm	225	390mm
<b>DA4278</b>	Range Rover Classic	Rear			18mm	285	385mm

The right choice when replacing the old sagging original springs!





# SUSPENSION & AXLE

## Springs

### Lowered Coil Springs & Kits

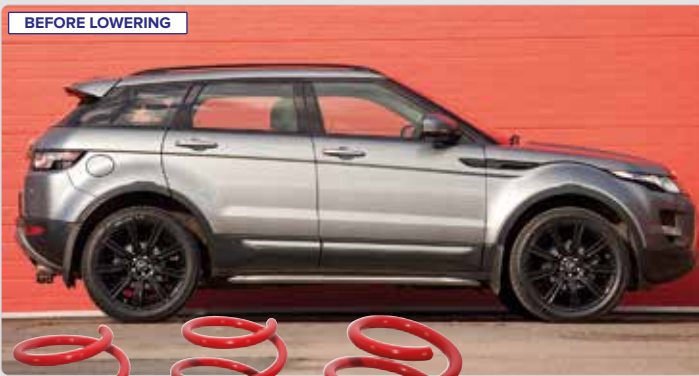

**Range Rover Evoque**  
**DA5135**  
 Range Rover Evoque  
 4WD 2.0 Si4/2.2 TD4/2.2 SD4  
 35mm Lowering springs kit  
 Front & rear

Reduce the ride height of your Land Rover by 1" (25mm). By lowering your vehicle it will help reduce body roll as well as giving your vehicle a more sporty squat stance and improve handling. The springs are designed in line with the standard spring rate specification and are finished in powder coated orange paint to match the anti-roll bars and shock absorbers.



**DA4563**  
 Front springs - pair  
 Defender 90/110  
 Discovery 1  
 Range Rover Classic  
 Rated - 171lb/in  
**DA4564**  
 Rear springs - pair  
 Defender 90  
 Discovery 1  
 Range Rover Classic  
 Rated - 245lb/in  
**DA6449**  
 Rear springs - pair  
 Defender 110  
 Rated - 211/343lb/in



**DA1234**  
**XD Handling Kit**  
 Defender 90  
 Discovery 1  
 Range Rover Classic with axle brackets  
 Kit contains -  
 > Britpart lowered coil springs  
 > Britpart Cellular Dynamic shock absorbers  
 > Anti-roll bars  
 > Turret rings  
 > Straps  
 > Ball joint assemblies  
 > Bushes  
 > Nuts, bolts and washers



### Air Lift Kits



**Air Lift 1000**  
**DA5010**  
 Defender 110/130  
**DA5011**  
 Defender 90/Discovery 1/Range Rover Classic  
 Air adjustability is the difference! Stiff steel factory suspensions must compromise between ride comfort and load hauling capacity. Smooth ride suspensions can't carry heavy loads; heavy springs ride rough, especially when the vehicle is unloaded. Air Lift adjustable air springs solve these problems by allowing you to tune your suspension under all load and road conditions. Just add air when towing or hauling and then remove air for a softer ride when unloaded.

- Features & Benefits of Air Lift 1000**
- > Improve ride, handling and stability by reducing roll, sway and 'bottoming out'
  - > Fits open coil springs, front or rear
  - > Up to 1,000lbs of levelling capacity
  - > Tough long-lasting moulded polyurethane construction
  - > Quick connecting easy-to-use engineered polymer air fittings



**DA5012**  
**Air Lift 1000 - Load Controller II**  
 The economical, popular, basic on board air system. This system controls the rear bags equally. All kits include wiring harness for fast, easy installation. To eliminate the major cause of air spring failure, the low pressure sensor automatically activates if pressure falls below the minimum safe level.

*Adjustable Air Helper Springs  
 The load and towing problem solver!*

### Old Man Emu Springs

Defender			Load	Lift	Spring Rate		Free Height
					lb/in	N/mm	
DA8910	Defender - 90/110/130 - diesel	Front	50kg	Up to 40mm	225	39	390mm
DA8924	Defender - 90 - diesel	Front	51 - 110kg	Up to 40mm	285	50	385mm
DA8914	Defender - 90/110 - petrol	Front	50kgs	Up to 40mm	200	35	400mm
DA8910	Defender - 90/110 - petrol	Front	51 - 110kg	Up to 40mm	225	39	390mm
DA8920	Defender - 90	Rear	100kg	Up to 40mm	220	39	430mm
DA8912	Defender - 90	Rear	200kg	Up to 40mm	300/340	52/60	420mm
DA1414	Defender - 110 <b>NEW</b>	Front	50kg	Up to 50mm	200	35	450mm
DA6841	Defender - 110	Rear	Station Wagon	Up to 25mm	175/200	31/35	440mm
DA8922	Defender - 110	Rear	300kg	Up to 50mm	300	52	435mm
DA8923	Defender - 110	Rear	500kg	Up to 55mm	420	74	435mm
3064	Defender - 110/130	Rear	Medium	Up to 50mm	175/200	31/35	520mm
3065	Defender - 110/130	Rear	300kg	Up to 50mm	270/330	47/58	515mm
3066	Defender - 110/130	Rear	500kg	Up to 50mm	370/430	65/75	500mm
DA8922	Defender - 130	Rear	Light Load	Up to 50mm	300	52	435mm
DA8923	Defender - 130	Rear	400kg	Up to 55mm	420	74	435mm
<b>Discovery</b>							
DA8910	Discovery 1 - diesel	Front	50kg	Up to 40mm	225	39	390mm
DA8914	Discovery 1 - petrol	Front	50kg	Up to 40mm	200	35	400mm
DA8924	Discovery 1	Front	51 - 110kgs	Up to 40mm	285	50	385mm
DA8920	Discovery 1	Rear	Medium	Up to 40mm	220	39	430mm
DA8912	Discovery 1	Rear	100kg	Up to 40mm	300/340	52/60	420mm
DA8955	Discovery 1	Rear	200kg	Up to 40mm	360	63	420mm
DA8915	Discovery 2	Front	21 - 50kg	Up to 40mm	180	32	395mm
2781	Discovery 2	Rear	Medium	Up to 40mm	290	51	425mm
DA8912	Discovery 2	Rear	100kg	Up to 40mm	300/340	52/60	420mm
DA8955	Discovery 2	Rear	200kg	Up to 40mm	360	63	420mm
DA8918	Discovery 3	Front	Standard	Up to 50mm	530	93	400mm
2745	Discovery 3	Front	100kg	Up to 50mm	670	117	390mm
2746	Discovery 3	Rear	Standard	Up to 50mm	530	93	400mm
2743	Discovery 3	Rear	200kg	Up to 50mm	800	140	360mm
<b>Range Rover</b>							
DA8910	Range Rover Classic - diesel	Front	50kg	Up to 40mm	225	39	390mm
DA8914	Range Rover Classic - petrol	Front	50kg	Up to 40mm	200	35	400mm
DA8924	Range Rover Classic	Front	51 - 110kg	Up to 40mm	285	50	385mm
DA8920	Range Rover Classic	Rear	Medium	Up to 40mm	220	39	430mm
DA8912	Range Rover Classic	Rear	100kg	Up to 40mm	300/340	52/60	420mm



- > Manufactured from state of the art micro-alloyed spring steel for superior strength and durability
  - > Double scragged before and after shot peening to reduce spring stress and enhance spring life
  - > Exceptional resistance to sagging and corrosion
  - > Springs are designed for each vehicle to match the spring to the specific applications
  - > Springs formed on computer controlled, precision mandrels to ensure manufacturing consistency
  - > Spring end configurations designed to exact specifications, guaranteeing perfect fitment to your vehicle
  - > Durable, hard wearing black powder coat
  - > Designed and manufactured in Australia
- Note** - See website for specific notes on certain springs. Available in the UK only.

*Springs are designed for each vehicle to match the spring to the specific applications*

### Old Man Emu Coil Set Packers

- OMELRCP1 Coil set packer - 8mm
  - OMELRCP2 Coil set packer - 8mm
  - OMELRCP3 Coil set packer - 8mm
- Available in the UK only.

OMELRCP1

OMELRCP2

OMELRCP3



### Air Springs



DA5091

RKB500240



Air springs can be susceptible to air leaks due to the fact the rubber seals dry out. Why not firm up your suspension and replace them with these quality air springs from Britpart?

#### Standard Springs

RKB101200	Discovery 2	Rear
DA2372	Range Rover P38	Front
DA2373	Range Rover P38	Rear
REB101740	Range Rover P38	Front
RKB101460	Range Rover P38	Rear

#### Lifted Springs

DA5091	Discovery 2	Plus 50mm lift kit
--------	-------------	--------------------

**Note** - All sold individually.

**RKB500082G NEW**  
Range Rover L322 - 2002 - 2012  
4.4 V8/4.2 V8 Supercharged/3.0 diesel  
From 6A233427

**RKB500240G NEW**  
Range Rover L322 - 2002 - 201  
3.6 V8 diesel  
From 7A000001

Rear

Rear



### Leaf Springs



These springs are manufactured to the original OEM specification and constructed from the correct grade alloy steel - 60SiCr8. Each leaf is heat treated consisting of hardening & tempering as the Land Rover engineers specified. Fitted with OEM bushes, these leaf springs will therefore give you years of service with the correct ride comfort for your Series vehicle.

<b>241283G</b>	SWB	Petrol	Front	9 Leaf	RHS
<b>242863G</b>	SWB	Petrol	Front	9 Leaf	LHS
<b>265627G</b>	SWB	Diesel	Front	11 Leaf	RHS
<b>264563G</b>	SWB & LWB	Diesel	Front	11 Leaf	LHS
<b>517588G</b>	SWB		Rear	11 Leaf	RHS
<b>517589G</b>	SWB		Rear	11 Leaf	LHS
<b>276034G</b>	LWB		Front	11 Leaf	RHS
<b>265627G</b>	LWB	Diesel & Petrol	Front	11 Leaf	RHS
<b>279678G</b>	LWB		Rear	10 Leaf	RHS
<b>279679G</b>	LWB		Rear	10 Leaf	LHS
<b>272967G</b>	LWB	Heavy-duty	Rear	8 Leaf	RHS
<b>272968G</b>	LWB	Heavy-duty	Rear	8 Leaf	LHS
<b>535173G</b>	LWB - 1 Ton		Rear	9 Leaf	RHS & LHS
<b>562627G NEW</b>	Lightweight		Front	7 Leaf	RHS
<b>562628G NEW</b>	Lightweight		Front	7 Leaf	LHS
<b>562631G</b>	Lightweight		Rear	7 Leaf	RHS
<b>562632G</b>	Lightweight		Rear	7 Leaf	LHS

279678G

265627G

517588G

272967G

535173G

562631G

241283G

Years of service with the correct ride comfort

### Leaf Spring Castor Correction Wedges



Can be used to correct castor or diff pin angle on leaf sprung vehicles by 3 degrees. Supplied as pairs.

**DA1211**  
Small pin - 13mm castor correction wedges

**DA1212**  
Large pin - 16mm castor correction wedges

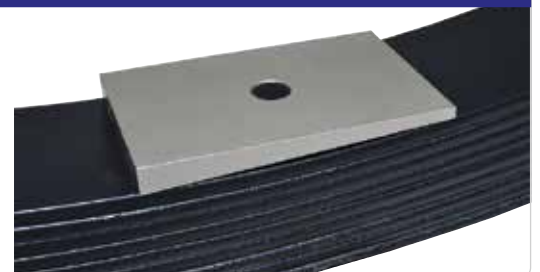

Parabolic Springs & Kits

*High quality parabolic springs are made to the exacting specifications as fitted to Santana specification vehicles*

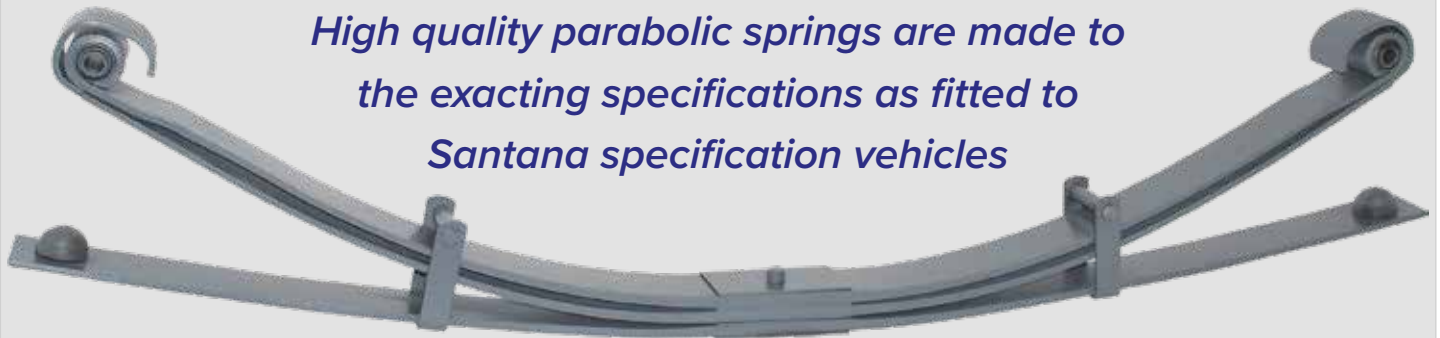

DA4106

DA4107



DA2003



The Britpart range of high quality parabolic springs are made to the exacting specifications as fitted to Santana specification vehicles.

Manufactured to an OEM standard and quality by using the correct grade alloy steel - 60SiCr8. Heat treated consisting of hardening & tempering and springs are shot peened before painting. These parabolic springs will bring a comfortable ride and improved handling to your Series vehicle.

DA4106	Series - SWB/LWB	2 Leaf	Front kit pair
DA4107	Series - SWB	3 Leaf	Rear kit pair
DA2003	Series - LWB	4 Leaf	Rear kit pair

Note - Includes 'U' bolts and nuts.

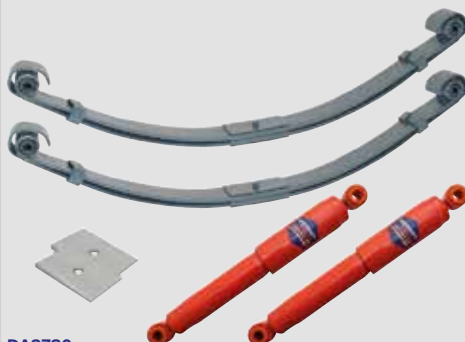

**DA2780**  
Parabolic Spring Kit - Front  
Series - SWB/LWB  
2 x Parabolic springs - 2-leaf  
2 x Long travel Cellular Dynamic shock absorbers  
2 x Angle correction wedges



**DA2781**  
Parabolic Spring Kit - Rear  
Series - SWB  
2 x Parabolic springs - 3-leaf  
2 x Long travel Cellular Dynamic shock absorbers  
2 x Angle correction wedges



**DA2782**  
Parabolic Spring Kit - Rear  
Series - LWB  
2 x Parabolic spring - 4-leaf  
2 x Long travel Cellular Dynamic shock absorbers  
2 x Angle correction wedges

Range of kits with high quality OEM parabolic springs paired with Britpart Cellular Dynamic shock absorbers. Also included in the kit are leaf spring castor correction wedges which can be used to correct castor or diff pin angle by 3 degrees. Parabolic springs include 'U' bolts and nuts.



Photo by Robert Rowlands



# SUSPENSION & AXLE

## Suspension Conversion Kits

### Airbag Man Intelliride Airbag Kits

#### Why Intelliride ECAS?

This front and rear axle full air suspension kit incorporates on-board air control which is a fully automatic Electronically Controlled Air Suspension (ECAS) System. When fitted, the system provides comfort while maintaining a programmed ride height irrespective of the load. Multiple vehicle heights are available at the push of a button.

The on-board system has automatic load levelling at each height which continuously monitors inputs and component performance as a means of increasing safety and durability. The on-board system recognises and responds accordingly to potholes, cross-articulation and extended turns. This intelligence prevents unnecessary activity and air consumption, it even recognises unachievable heights, assisting in the prevention of possible damage above or below the vehicle.

#### Features

- > Automatic 4 corner ride height control catering for all loads
- > 3 pre-set heights - high, drive & low mode
- > Fully adjustable via easy to use hand held control
- > Front to back levelling
- > Raise for clearance
- > Lower for storage and access
- > Inputs available for safety reset to ride height
- > Manual mode
- > Horizon levelling feature option
- > OEM grade components for reliable performance
- > High volume air springs for optimal ride quality & carrying capacity

#### Core Components

- > Rear Firestone air springs - heavy-duty rolling sleeve air springs
- > Front Dunlop air springs - heavy-duty rolling sleeve air springs includes shock relocation brackets
- > AMK air compressor - 12 volt. Max 150 psi working pressure, high quality German built compressor
- > 1 Gallon seamless aluminium air tank - SAE J10 APPROVED, lightweight & no corrosion. Max. working pressure 200psi. Pressure tested to 1,000psi. 3 x 1/4" NPT ports (including drain port). Multi-position low profile bracket set
- > Hand held controller - 9m lead
- > ECU & valve block
- > Vehicle specific air supply mounting brackets
- > Rocker switch & height sensors
- > 6mm high quality nylon tubing
- > Quick fit push to connect air fittings
- > Easy to use electrical connections
- > Sealed relay & harness
- > Hardware
- > Step by step instructions
- > Operators manual

#### DA9200 NEW

##### Defender 90

Height Range Automatic Mode	Front	Rear
Ride height up to raised height	40mm	40mm
Ride height down to access height	-80mm	-80mm

##### Height Range Manual Mode

Maximum height from ride height	50mm	50mm
Minimum height from ride height	-100mm	-100mm

#### DA9201 NEW

##### Defender 110/130

Height Range Automatic Mode	Front	Rear
Ride height up to raised height	40mm	60mm
Ride height down to access height	-80mm	-90mm

##### Height Range Manual Mode

Maximum height from ride height	50mm	70mm
Minimum height from ride height	-100mm	-110mm



See them in action  
www.britpart.com /airbag



DA9200



DA9200



HIGH MODE



DRIVE MODE



LOW MODE

DA9201



HIGH MODE



DRIVE MODE



LOW MODE

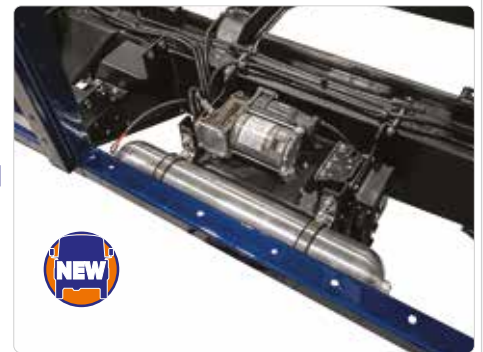

Photo by Pieter Nel



**Defender 4-Corner Air Suspension Conversion Kit**

*How about modifying your Defender with improved on-road behaviour for daily use and the ability of increased ground clearance when venturing off-road?*

When your Defender is fitted with the standard coil suspension, the ride is a compromise between off-road ability, load carrying and normal road use. By using a full air suspension kit, ride quality is improved and vehicle height can be altered by moving to a pre-set relevant to your needs. Vehicle height and wheel travel then stays in the optimal working range for suspension performance and comfort at all legal loads\*.

**Benefits of Full Air Conversion**

- > Improved vehicle stability and handling under all loaded conditions
- > Increased comfort and enhanced driving experience
- > Fully adjustable heights with intelligent controls
- > Optimized geometry
- > Constant ride height under all loaded conditions up to vehicle full GVW\*
- > Easily installed and user friendly system

High quality materials are used to give you the most reliable kit for your Land Rover. Bespoke air spring units are used in conjunction with a turret setup & electronic control system. Electronic components have been durability tested and in many cases are shared with those fitted to many European cars for factory fit air suspension. The compressor from AMK is very robust with low noise & vibration. The kit comes complete with full instructions and all the necessary parts, it's easy to install and requires minimal drilling during fitment.

**Kit Features**

- > Constant ride height\*
- > Increased comfort
- > Improved stability & driveability
- > Pre-set heights for electronic control system
  - Access - Low for easy entry/exit
  - Ride height - Normal road use
  - Off-road
- > Additional tilt features available
- > Multi-axis horizon levelling add-on feature available on request

**Technical Specification**

Wheel travel	≈180mm
Off-road position	+40mm
Access position	-60mm

\*Please refer to Land Rover for Defender official payload capability.

DA9110

Defender 110 & 130

**Compatibility**

It is important you abide by this compatibility list in order to protect the components in the air suspension kit. Any parts warranty claim would be void if this criteria is not followed.

**Bump Stops** - Minimum height from chassis 70mm. Bump stop spacers are provided to meet this criteria when using standard Land Rover factory bump stops.

**Anti-roll Bars** - Passive front and rear anti-roll bars must be fitted.

**Shock Absorbers** - Front shock absorber maximum length - 545mm. Rear shock absorber maximum length - 535mm



Photo by Luis Gutierrez



### Air Spring Conversion Kits



DA5137



DA5007



DA5097

#### Discovery 2

It is a sad fact that it's likely the air suspension on your Discovery 2 will fail - probably at the most inconvenient time possible. You then have a choice to make. Do you replace it with a new air spring system which is comfortable but not so comfortable on your wallet or replace with an equally comfortable but much more affordable and reliable coil spring system? Britpart have the complete kit for air to coil spring conversion making your decision that little bit easier.

<b>DA5136</b>	Standard ride height	Rear kit - black springs	
<b>DA5137</b>	2" lift ride height	Rear kit - yellow springs	
<b>DA5007</b>	2" lift ride height - heavy-duty	Front & rear kit - yellow springs	Ideal if winch is fitted
<b>DA5008</b>	2" lift ride height	Front & rear kit - yellow springs	

#### Range Rover P38

The EAS (Electronic Air Suspension) System found on Range Rover 4.0 and 4.6 vehicles can present expensive, recurring maintenance problems. If you've had an air spring failure before, you know this first hand. Britpart now has a coil spring conversion kit for Range Rover 4.0 and 4.6 that makes switching to coil springs seamless and error-free. Conversion to coil springs provides a better, maintenance-free ride that will save you significant money over time. The EAS Override Module suppresses all typical false dashboard display errors and buzzers seen when converting to coil springs. Any mechanic or Range Rover owner can install this coil spring conversion kit without having to go to a Land Rover dealer or Autologic-equipped repair shop to eliminate false dash warning light errors.

#### The kit features:

- > Detailed step-by-step instructions
- > The EAS Override Module overrides all typical computer errors seen when converting to coil springs
- > Eliminates the need for a costly shop visit
- > Aluminium spring perch adapters
- > Britpart custom made coil springs provide standard ride height and maximum articulation
- > Affordable alternative to expensive, recurring air suspension failures
- > Trip computer compatibility - maintains operation of your vehicle's trip computer
- > Kit provides everything needed to complete a professional installation



DA4136EAS

#### DA4136

Range Rover P38 - 1995 - 2002  
Petrol models and diesel light duty

#### DA4136HD

Range Rover P38 - 1995 - 2002  
Heavy-duty 1" lift including diesel models

#### DA4136BUSH

Britpart yellow polyurethane bush kit for DA4136 & DA4136HD

#### BL4136BUSH

Britpart black polyurethane bush kit for DA4136 & DA4136HD

#### DA4136FR

Pair of replacement front coil springs for DA4136

#### DA4136RR

Pair of replacement rear coil springs for DA4136

#### DA4136HDFR

Pair of replacement front coil springs for DA4136HD

#### DA4136HRRR

Pair of replacement rear coil springs for DA4136HD

#### DA4136EAS

Range Rover P38 - 1995 - 2002

EAS override module suppresses all typical false dashboard display errors and buzzers seen when converting to coil springs.



DA4136HD

#### Discovery 3 & Discovery 4

**Does the complexity of having air suspension on your Discovery worry you?**

Discovery coil conversion kit with module.

This comprehensive kit contains everything you need to convert to conventional coil spring suspension. Kit comprises four strut units and module to prevent the air suspension lights from being illuminated. **Note** - In some Discovery 3 installations it will be necessary to purchase 2 x RNG500060 to ensure correct ride height is achieved.

**DA5034** Discovery 3

**DA5097** Discovery 4

*Air to coil spring conversion kits from Britpart - get a reliable and maintenance-free ride for your Land Rover!*

#### Range Rover Classic

#### DA4180

Range Rover Classic 1" lift No module

#### DA4179

Range Rover Classic No module

DA4180



Photo by Nicola Kimber

### Britpart Super Gaz Suspension Kits

#### Shock Absorber & Spring Kits

<b>DA4284</b>	Defender 90/Discovery 1/Range Rover Classic	Heavy-duty	Standard height
<b>DA4301</b>	Defender 90/Discovery 1/Range Rover Classic	Light-duty	25mm lift
<b>DA4286</b>	Defender 90/Discovery 1/Range Rover Classic	Light-duty	40mm lift
<b>DA4286MD</b>	Defender 90/Discovery 1/Range Rover Classic	Medium-duty	40mm lift
<b>DA4286HD</b>	Defender 90/Discovery 1/Range Rover Classic	Heavy-duty	40mm lift
<b>DA4285</b>	Defender 110	Heavy-duty	Standard height
<b>DA4287</b>	Defender 110	Heavy-duty	40mm lift

#### Full Suspension Kits

<b>DA4288</b>	Defender 90 - up to 1994/Range Rover Classic - up to 1986	Narrow bush	Light-duty	40mm lift
<b>DA4288MD</b>	Defender 90 - up to 1994/Range Rover Classic - up to 1986	Narrow bush	Medium-duty	40mm lift
<b>DA4288HD</b>	Defender 90 - up to 1994/Range Rover Classic - up to 1986	Narrow bush	Heavy-duty	40mm lift
<b>DA4289</b>	Defender 90 - 1994 onwards/Discovery 1/Range Rover Classic - 1986 onwards	Wide bush	Light-duty	40mm lift
<b>DA4289MD</b>	Defender 90 - 1994 onwards/Discovery 1/Range Rover Classic - 1986 onwards	Wide bush	Medium-duty	40mm lift
<b>DA4289HD</b>	Defender 90 - 1994 onwards/Discovery 1/Range Rover Classic - 1986 onwards	Wide bush	Heavy-duty	40mm lift
<b>DA4299</b>	Defender 110 - up to 1994	Narrow bush	Heavy-duty	40mm lift
<b>DA4300</b>	Defender 110 - 1994 onwards	Wide bush	Heavy-duty	40mm lift



CELLULAR DYNAMIC - FULL SUSPENSION KIT



SUPER GAZ - SHOCK ABSORBER & SPRING KIT

#### Full suspension kits

- > Springs - front & rear
- > Shock absorbers - front & rear
- > Radius arms - front & rear
- > Spring retainers - front & rear
- > Bush sets

#### Shock absorber & spring kits

- > Springs - front & rear
- > Shock absorbers - front & rear

**Note** - Some additional fixings may be needed for some kits.

Britpart offers you a **complete** or **partial suspension package** suitable for whatever you intend to use your Land Rover for.

### Britpart Cellular Dynamic Suspension Kits

#### Shock Absorber & Spring Kits

<b>DA4284C</b>	Defender 90/Discovery 1/Range Rover Classic	Heavy-duty	Standard height
<b>DA4301C</b>	Defender 90/Discovery 1/Range Rover Classic	Light-duty	25mm lift
<b>DA4286C</b>	Defender 90/Discovery 1/Range Rover Classic	Light-duty	40mm lift
<b>DA4286CMD</b>	Defender 90/Discovery 1/Range Rover Classic	Medium-duty	40mm lift
<b>DA4286CHD</b>	Defender 90/Discovery 1/Range Rover Classic	Heavy-duty	40mm lift
<b>DA4285C</b>	Defender 110	Heavy-duty	Standard height
<b>DA4287C</b>	Defender 110	Heavy-duty	40mm lift

#### Full Suspension Kits

<b>DA4288C</b>	Defender 90 - up to 1994/Range Rover Classic - up to 1986	Narrow bush	Light-duty	40mm lift
<b>DA4288CMD</b>	Defender 90 - up to 1994/Range Rover Classic - up to 1986	Narrow bush	Medium-duty	40mm lift
<b>DA4288CHD</b>	Defender 90 - up to 1994/Range Rover Classic - up to 1986	Narrow bush	Heavy-duty	40mm lift
<b>DA4289C</b>	Defender 90 - 1994 onwards/Discovery 1/Range Rover Classic - 1986 onwards	Wide bush	Light-duty	40mm lift
<b>DA4289CMD</b>	Defender 90 - 1994 onwards/Discovery 1/Range Rover Classic - 1986 onwards	Wide bush	Medium-duty	40mm lift
<b>DA4289CHD</b>	Defender 90 - 1994 onwards/Discovery 1/Range Rover Classic - 1986 onwards	Wide bush	Heavy-duty	40mm lift
<b>DA4299C</b>	Defender 110 - up to 1994	Narrow bush	Heavy-duty	40mm lift
<b>DA4300C</b>	Defender 110 - 1994 onwards	Wide bush	Heavy-duty	40mm lift
<b>DA1234</b>	Defender 90/Discovery 1/Range Rover Classic - with axle brackets	XD Handling kit	1" lower	

#### 40mm Lift Suspension Kits Using Plus 5" Shock Absorbers

<b>DA4363</b>	Defender 90/Discovery 1/Range Rover Classic	Shock absorber & spring kit	Light-duty	Plus 5" shock*	40mm lift
<b>DA4364</b>	Defender 110	Shock absorber & spring kit	Heavy-duty	Plus 5" shock*	40mm lift
<b>DA4365</b>	Defender 90 - up to 1994/Range Rover Classic - up to 1986	Full suspension kit	Medium-duty	Plus 5" shock*	40mm lift
<b>DA4366</b>	Defender 90 - 1994 onwards/Discovery 1/Range Rover Classic - 1986 onwards	Full suspension kit	Wide bush	Plus 5" shock*	40mm lift
<b>DA4367</b>	Defender 110 - up to 1994	Full suspension kit	Narrow bush	Plus 5" shock*	40mm lift
<b>DA4368</b>	Defender 110 - 1994 onwards	Full suspension kit	Wide bush	Plus 5" shock*	40mm lift



**Note** - The Plus 5" Cellular Dynamic Shock Absorbers are specialist suspension products and to install them additional fabrication work or brackets may be required.

**Please ensure that they are fitted by a competent expert.**

Open and closed dimensions -

**DC6000LL** - 765 - 455mm

**DC60001LL** - 750 - 440mm



Photo by Jane Brinkmann

### Old Man Emu Handling Kits



DA1740

#### Defender 90

**DA1740**

Medium-duty full kit

**DA1741**

Heavy-duty full kit

#### Defender 110

**DA2861**

Medium-duty full kit

**DA2862**

Heavy-duty full kit

**Note** - Kit lifts Defender from standard height to between 1" & 2" dependent on kit fitted (winch etc).

Any suspension modification should have a full wheel alignment to ensure the vehicle is set up correctly and does not cause uneven tyre wear.

- > Fully integrated Old Man Emu handling kits for all ride types
- > Designed and tested by a team of specialist engineers in Australia
- > Superior performance across all terrain
- > Dramatically improved high and low speed control for increased comfort



Available in the UK only.



# SUSPENSION & AXLE

## Propshafts

### Propshaft Spacer Kits

Defender  
Discovery 1  
Range Rover Classic  
**DA6339**  
15mm spacer kit  
**DA633925**  
25mm spacer kit

Propshaft spacer kit machined from billet aluminium and anodised deep blue. When suspension lift kit is fitted it increases the distance between the transfer box flange and the diff flange. This increased distance can cause the propshaft to run out of spline travel.

Fitting this prop spacer helps return the propshaft to its normal operating length therefore allowing full spline travel which also helps reduce the characteristic "binding" of the yokes when a propshaft is over extended.



**DA633925**

### Propshaft & Flange Bolt Kits

**DA1423**  
4 x 509045P - Propshaft bolt  
4 x BT60610IL - UNC flange bolt  
8 x NZ606041L - Nut

**DA1424**  
4 x 509045P - Propshaft bolt  
4 x FRC3602 - UNF flange bolt  
8 x NZ606041L - Nut

**DA1123**  
Wide angle nut & bolt kit suitable for DA6350; DA6351; DA6352, DA6353 & DA6354

**DA1424**



### Propshaft Kit

**DA6355**

Defender/Discovery 1/Range Rover Classic - 300Tdi & Td5 manual models only  
 > Double cardan extreme use front propshaft with flange and fitting kit  
 > For vehicles with L230 transfer boxes  
 > Ideal for use with lifted vehicles  
 > Helps to reduce driveline vibration where diff and transfer flanges are not in-line  
**Note** - Flange must be fitted to transfer box.



### Wide Angle Propshafts

If your Land Rover has raised suspension or been modified for extreme axle articulation then the joints on the existing propshaft will become strained. This will cause the propshaft to lock up or vibrate and wear the universal joints prematurely. Dropping the axle further away from the chassis is great for looks, articulation and off-road performance - a neat solution is to fit a wide angle propshaft. This allows drivetrain angles of up to 32 degrees which reduces vibration, universal joint 'bind-up' and premature wear on the joints. These wide angle shafts have greasable universal joints which are more desirable where longer life is required.

<b>DA6350</b>	Front Defender - from MA - 300Tdi & Td5/Discovery 1 Range Rover Classic - 1986 - 1991 Extended - 678mm / Closed - 612mm	FRC8386
<b>DA6352</b>	Front Defender - up to LA (1993) Extended - 720mm / Closed - 652mm	FRC8390/FRC5566
<b>DA6351</b>	Rear Defender 90 - 4 cylinder Extended - 705mm / Closed - 635mm	FRC8392
<b>DA6353</b>	Rear Defender 90 - V8 - up to 2007 & diesel from MA Extended - 755mm / Closed - 685mm	FRC8393
<b>DA6354</b>	Rear Discovery 1 - 1989 - 1994 & V8 from 1997 Extended - 940mm / Closed - 873mm	FRC8387
<b>DA6356</b>	Replacement heavy-duty universal joint for wide angle propshafts	
<b>DA1123</b>	Nut & bolt kit - each kit contains 4 nuts - for transfer box end & 4 nuts & bolts - for diff end. Enough nuts & bolts to make propshaft repair out in the field. Suitable for DA6350; DA6351; DA6352, DA6353 & DA6354.	



**DA6553**

**DA6356**

**DA1123**

## Steering

### Steering Dampers

**Britpart Cellular Dynamic**

**DC6004** Defender  
**DC6005** Discovery 1/Range Rover Classic/Series  
**DC6009** Discovery 2  
**DC6006** Range Rover P38

**Britpart Super Gaz**

**DC5004** Defender  
**DC5005** Discovery 1/Range Rover Classic/Series

**Girling Classic**

**RTC4472GIRLING NEW**

Defender - 1987 - 2016



**Old Man Emu**

**DA8925** Defender 90, 110 & 130  
**500555** Replacement mounting kit for DA8925  
**DA3066** Discovery 1  
**DA3135** Discovery 2  
**DA3066** Range Rover Classic

> 9 stage valving for optimum performance  
 > Massive 35mm bore  
 > Stone guard  
 > Fits original mounts  
 > 50/50 valving



Steering dampers with nitrogen charged foam cell for reduced wheel vibration and improved handling and control. Available in the UK only.

### Heavy-Duty Steering Arms

> Solid heavy-duty arms which are suitable for off-road use  
 > Improves steering response  
 > Zinc plate finish to increase corrosion resistance

	With Grease Nipples	With OEM Track Rod Ends		Track Rod End Replacements
<b>DA5501</b>	<b>DA5501M</b>	<b>DA5501G</b>	Series	4 track rod ends 2 x RTC5867 & 2 x RTC5868
<b>DA5502</b>	<b>DA5502M</b>	<b>DA5502G</b>	Defender 90/110	3 track rod ends 2 x RTC5869 & 1 x RTC5870
<b>DA5503</b>	<b>DA5503M</b>	<b>DA5503G</b>	Discovery 1	3 track rod ends 2 x RTC5869 & 1 x RTC5870
			Range Rover Classic	
<b>DA5504</b>	<b>DA5504M</b>	<b>DA5504G</b>	Discovery 1	4 track rod ends 2 x RTC5869 & 2 x RTC5870
<b>DA5509</b>			Discovery 2	4 track rod ends
<b>DA5541</b>	Fixing kit for DA5503 & DA5504			
<b>DA5527</b>	Left hand replacement nut for DA5501/DA5502/DA5503/DA5504			
<b>DA5528</b>	Right hand replacement nut for DA5501/DA5502/DA5503/DA5504			

*Improves steering response*

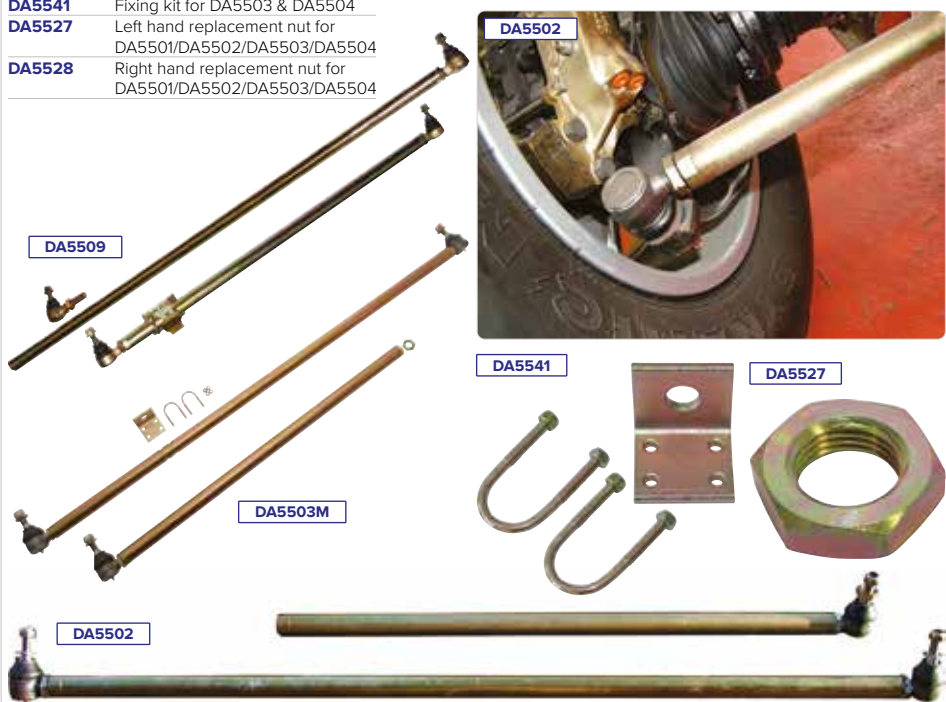

**DA5509**

**DA5502**

**DA5541**

**DA5527**

**DA5503M**

**DA5502**

	Defender 90	Defender 110	Discovery 1	Discovery 2	Range Rover Classic	Range Rover P38	Series
<b>Super Gaz Shock Absorbers</b>							
<b>Front</b>							
Standard	DC5002	DC5002	DC5002	DC5000	DC5002		
50mm lift	DC5002L	DC5002L	DC5002L	DC5000L	DC5002L		
<b>Rear</b>							
Standard	DC5003	DC5003	DC5003	DC5001	DC5003		
50mm lift	DC5003L	DC5003L	DC5003L	DC5001L	DC5003L		
<b>Steering Dampers</b>							
Standard	DC5004	DC5004	DC5005		DC5005		DC5005
50mm lift	DC5004	DC5004	DC5005		DC5005		DC5005
<b>Super Gaz Shock Absorber Suspension Kits</b>							
<b>Shock Absorber &amp; Spring Kits</b>							
Standard - heavy-duty kit	DA4284	DA4285	DA4284		DA4284		
25mm lift - light-duty kit	DA4301		DA4301		DA4301		
40mm lift - light-duty kit	DA4286		DA4286		DA4286		
40mm lift - medium-duty kit	DA4286MD		DA4286MD		DA4286MD		
40mm lift - heavy-duty kit	DA4286HD	DA4287	DA4286HD		DA4286HD		
40mm lift - no winch - kit				DA5008			
40mm lift - with winch - kit				DA5007			
<b>Full Suspension Kits</b>							
40mm lift - narrow bush - light-duty kit	DA4288				DA4288		
40mm lift - narrow bush - medium-duty kit	DA4288MD				DA4288MD		
40mm lift - narrow bush - heavy-duty kit	DA4288HD	DA4299			DA4288HD		
40mm lift - wide bush - light-duty kit	DA4289		DA4289		DA4289		
40mm lift - wide bush - medium-duty kit	DA4289MD		DA4289MD		DA4289MD		
40mm lift - wide bush - heavy-duty kit	DA4289HD	DA4300	DA4289HD		DA4289HD		
<b>Cellular Dynamic Shock Absorbers</b>							
<b>Front</b>							
Standard	DC6000	DC6000	DC6000	DC6010	DC6000	DC6002	
50mm lift	DC6000L	DC6000L	DC6000L		DC6000L		
Plus 5" shock absorber	DC6000LL	DC6000LL	DC6000LL		DC6000LL		
<b>Rear</b>							
Standard	DC6001	DC6001	DC6001	DC6011	DC6001	DC6003	
50mm lift	DC6001L	DC6001L	DC6001L		DC6001L		
Plus 5" shock absorber	DC6001LL	DC6001LL	DC6001LL		DC6001LL		
<b>Steering Dampers</b>							
Standard	DC6004	DC6004	DC6005	DC6009	DC6005	DC6006	DC6005
50mm lift	DC6004	DC6004	DC6005		DC6005		
Plus 5" shock absorber	DC6004	DC6004	DC6005		DC6005		
<b>Cellular Dynamic Shock Absorber Suspension Kits</b>							
<b>Shock Absorber &amp; Spring Kits</b>							
Standard height - heavy-duty kit	DA4284C	DA4285C	DA4284C		DA4284C		
25mm lift - light-duty kit	DA4301C		DA4301C		DA4301C		
40mm lift - light-duty kit	DA4286C		DA4286C		DA4286C		
40mm lift - medium-duty kit	DA4286CMD		DA4286CMD		DA4286CMD		
40mm lift - heavy-duty kit	DA4286CHD	DA4287C	DA4286CHD		DA4286CHD		
Plus 5" shock absorber - light-duty kit	DA4363		DA4363		DA4363		
Plus 5" shock absorber - heavy-duty kit		DA4364					
<b>Full Suspension Kits</b>							
40mm lift - narrow bush - light-duty kit	DA4288C				DA4288C		
40mm lift - narrow bush - medium-duty kit	DA4288CMD				DA4288CMD		
40mm lift - narrow bush - heavy-duty kit	DA4288CHD	DA4299C			DA4288CHD		
Plus 5" shock - narrow bush - medium-duty kit	DA4365				DA4365		
Plus 5" shock - narrow bush - heavy-duty kit		DA4367					
40mm lift - wide bush - light-duty kit	DA4289C		DA4289C		DA4289C		
40mm lift - wide bush - medium-duty kit	DA4289CMD		DA4289CMD		DA4289CMD		
40mm lift - wide bush - heavy-duty kit	DA4289CHD	DA4300C	DA4289CHD		DA4289CHD		
Plus 5" shock absorber - wide bush - medium-duty kit	DA4366		DA4366		DA4366		
Plus 5" shock absorber - wide bush - heavy-duty kit		DA4368					



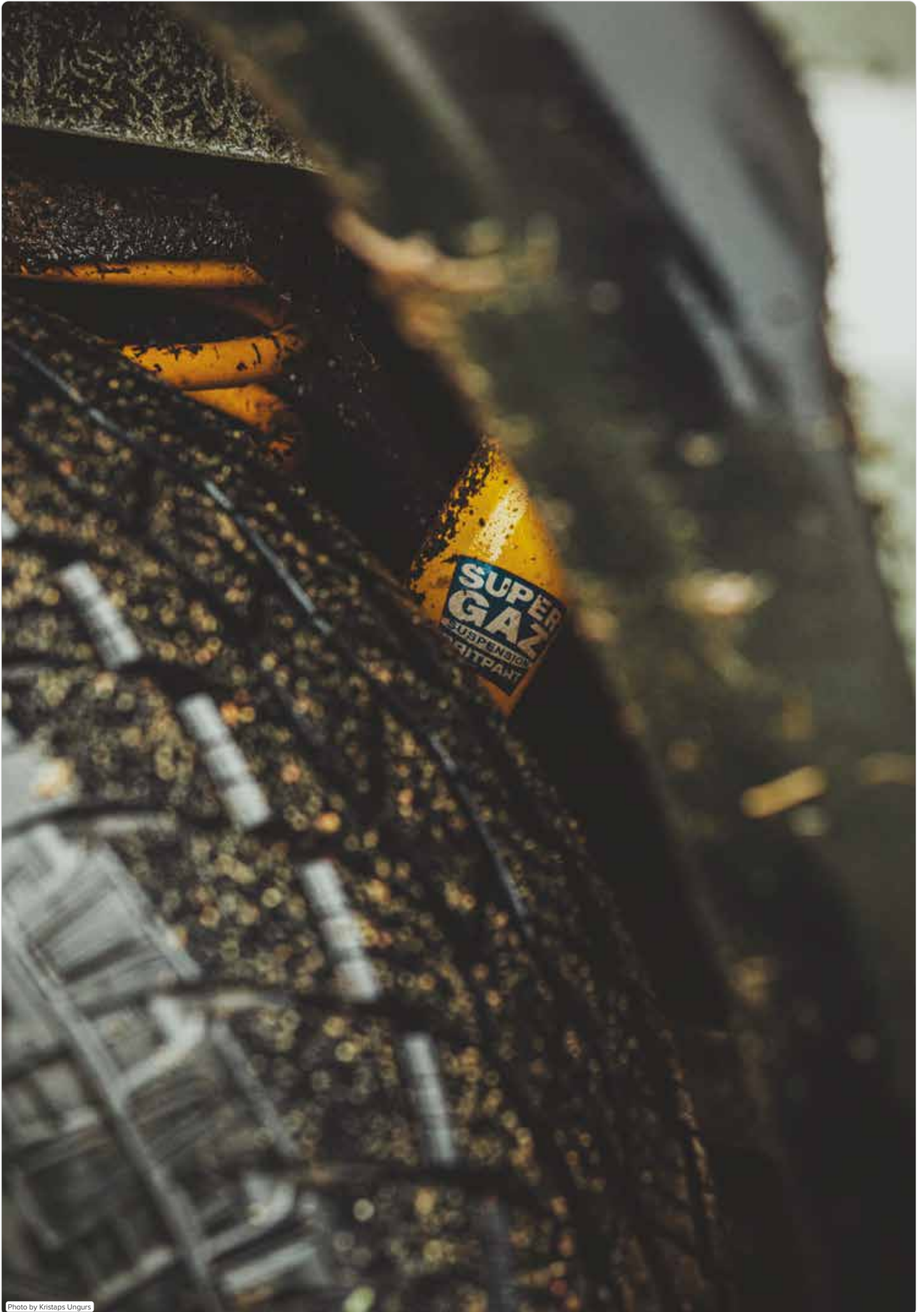

Photo by Kristaps Ungurs

# DIAGNOSTICS



*Servicing & In Depth  
Diagnostic Capability*



### What is Lynx Evo?

Lynx Evo is the next generation diagnostic tool for Land Rover vehicles. Offering market leading diagnostics from a powerful and mobile design. Lynx Evo provides vehicle servicing and in depth diagnostic capability for all Land Rover models from 1990 through to current day. Ideal for the workshop and home user.

Live data can also be displayed using numerics and graphics making it easier to read time based events on your Land Rover. This small but powerful Dongle requires no batteries as it uses the vehicles power. For the enthusiast home user, using Lynx Evo will mean no more trips to your local main dealer to clear any faults on your Land Rover.

Lynx Evo is compatible with iOS and Android\* mobile devices with apps available for download from the Apple App Store and Android Play Store. As the software is App Store based and is loaded onto your mobile device, updates are as easy to do as any other mobile app, simply click the update icon.

### What does Lynx Evo do?

- > Read fault codes
- > Clear fault codes
- > Read & display live data
- > Test actuators
- > Special functions - see online coverage  
*Please go online to check out the function for your Land Rover @ [www.lynx-diagnostics.com/coverage](http://www.lynx-diagnostics.com/coverage)*
- > Programming - such as alarm settings, key fobs etc. on selected models
- > Service reset

### What do you get with Lynx Evo?

- > Lynx Evo dongle
- > Quick start guide

### Supported Languages

- > English
- > French
- > Spanish
- > Portuguese
- > German
- > Italian
- > Dutch



### What do I need?

**Important** - Lynx Evo and Lynx Evo Pro are not for sale or use in Canada, Mexico or USA. Please check that the Lynx Evo App is available in your country before ordering.

#### DA3600

#### Lynx Evo 2

Single Land Rover family (see 'What models does Lynx cover' - below)  
Land Rover family home user version. Unlocked for one Land Rover family only. Upgradable to allow extra Land Rover families to be added at a later date. **Important** - After 36 months you will need to purchase a new 12 month licence to be able to continue to use the tool.

#### Extras

**See app for full details** - Unlock code for additional Land Rover families - 12 months licence. Requested via [lynxevo@britpart.co.uk](mailto:lynxevo@britpart.co.uk)

**DA1504** Cable kit - 14CUX, air suspension & ABS

**DA1505** Range Rover P38 cable kit Check & diagnose BECM and check, diagnose & calibrate air suspension

**DA6433** Upgrade lead - power cable for use with firmware updates

**DA6433EU** Upgrade lead - European 2-pin power cable for use with firmware updates

### What Land Rover models does Lynx Evo cover?

It is important to note that if you purchase an unlock code for a Discovery this code will cover all the Discovery family - from Discovery 1 through to Discovery 4. This feature is hugely beneficial if, at a later date, you upgrade your vehicle within the same Land Rover family you don't have to purchase another unlock code which can be requested via [lynxevo@britpart.co.uk](mailto:lynxevo@britpart.co.uk)  
See the full Lynx coverage for each model at

[www.lynx-diagnostics.com/coverage](http://www.lynx-diagnostics.com/coverage)

#### Defender Family

- > Defender - 1990 to 2019

#### Discovery Family

- > Discovery 1\*
- > Discovery 2
- > Discovery 3
- > Discovery 4
- > Discovery 5

#### Freelander Family

- > Freelander 1
- > Freelander 2

#### Discovery Sport Family

- > Discovery Sport

#### Range Rover Family

- > Range Rover Classic\*
- > Range Rover P38
- > Range Rover L322
- > Range Rover L405

#### Range Rover Velar Family

- > Range Rover Velar

#### Range Rover Evoque Family

- > Range Rover Evoque

#### Range Rover Sport Family

- > Range Rover Sport - Mk1
- > Range Rover Sport - Mk2

## Upgrade software over app store



\*Lead for 14CUX required - DA1504

Example screen shots showing some of the different Lynx Evo display modes.

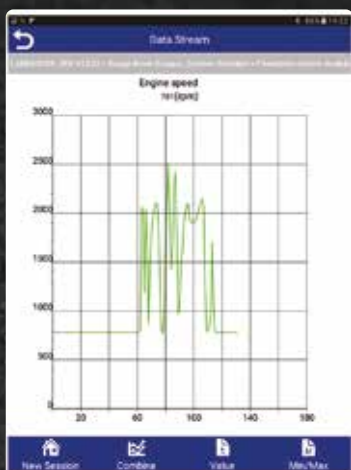

**Key Features**

- > Read & display live data
- > Mobile device based
- > Easy to use
- > Unlocked ready to cover an entire Land Rover model family
- > Upgrade software over app store
- > Quickly checks your Land Rover for faults
- > Small enough to store in glove box

See the full Lynx coverage for each model at

[www.lynx-diagnostics.com/coverage](http://www.lynx-diagnostics.com/coverage)

**Ideal for the workshop & home user**



Lynx Evo FAQ's available online

[www.lynx-diagnostics.com](http://www.lynx-diagnostics.com)

For Lynx Legacy - see overleaf

The Small Print  
 iPhone® - Made for iPhone® & can be used with a iPad® mean that an electronic accessory has been designed to connect specifically to iPhone or iPad respectively and has been certified by the developer to meet Apple performance standards. Apple is not responsible for the operation of this device or its compliance with safety and regulatory standards. Please note that the use of this accessory with iPhone or iPad may affect wireless performance. iPhone & iPad are trademarks of Apple Inc., registered in the U.S. and other countries.  
 Android - Android versions greater than V10 are available via a supplied link by technical support - lynxevo@britpart.co.uk



# DIAGNOSTICS

## Lynx Legacy Replacement Parts



**DA6430CABLE**  
Replacement ODB to VCI cable for Lynx Diagnostics units



**DA6433**  
Upgrade lead - power cable for use with firmware updates



**DA6433EU**  
Upgrade lead - European 2-pin power cable for use with firmware updates



## Lynx Evo Legacy Parts



**DA1502**  
Unlock code for additional Land Rover families



**DA1503**  
Lynx Evo product for a single model family software update voucher code.  
12 months software update entitlement.



**DA1506**  
Lynx Evo Pro software update voucher code.  
12 months software update entitlement.



## Calibration Tools



**LRT-60-003**

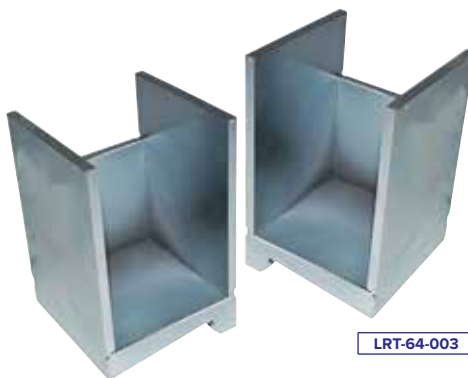

**LRT-64-003**

To help with air suspension calibration we also offer these calibration blocks which can be used in conjunction with our Lynx diagnostics kit.

**LRT-60-003** Range Rover P38

**LRT-64-003** Discovery 2



## Jaguar Land Rover DOIP SST



**The original and cost-effective answer to Jaguar Land Rover servicing.**

### DA2915

Helps independent all-makes workshops to keep up to date with the latest service functions such as service light reset, electronic park brake release and more on DOIP vehicles. Fast start up times means it takes less time to complete those service jobs and leaves your diagnostic tool free to carry out the more complex jobs. This compact tool has a simple intuitive colour screen with a button membrane and means this tool can be used anywhere in the workshop. This JLR approved device works with all current and future DOIP vehicles.

### Features

- > Intuitive simple user interface, colour screen with button membrane
- > Wi-Fi connectivity allowing remote device connection, application download updates, supported via optional USB Wi-Fi dongle
- > Encrypted secure data connection to AWS cloud services
- > J2534, DPDU support for existing retailer diagnostic tools
- > Support for remote diagnostic runtime interface, pay as you go application support
- > Approved JLR applications for the JLR SST
- > Transport mode toggle (TMT) with speed limiter enable/disable
- > Diesel exhaust fluid (DEF) measurement
- > Service oil indicator reset (SIR)
- > Electronic park brake release (EPBR)
- > Diesel particulate filter dynamic regeneration (DPFDR)
- > Tight tolerance toggle (TTMT)
- > Oil level measurement

### Vehicle Coverage

- > Range Rover L405 (17MY onward)
- > Range Rover Sport L494 (17MY onward)
- > Discovery 5 L462 (17MY onward)
- > Evoque L538 (18MY onward)
- > Discovery Sport L550 (18MY onward)
- > Range Rover Velar L560 (18MY onward)
- > Defender L663 (20MY onward)
- > Jaguar F-TYPE X152 (18MY onward)
- > Jaguar F-PACE X761 (18MY onward)
- > Jaguar XE X760 (18MY onward)
- > Jaguar XF X260 (18MY onward)
- > Jaguar E-PACE X540 (18MY onward)
- > Jaguar I-PACE X590 (19MY onward)

### Note

You will need to register your product to unlock it for use. To register your product, you will need to first download the Diagnostic Associates App Hub from the website here. Please follow the advice in the User Manual, which can be found in TOPIx. It is important to install the Diagnostic Associates App Hub before plugging your device into your computer.



Britpart

*Want to guarantee you can cover every JLR vehicle that comes into your workshop?*

*Choose the easy, future proof & profitable route of full dealer diagnostic tools.*

Have the ability to offer main dealer level service.

- > Full diagnostics with SDD & Pathfinder
- > Online service record updating
- > Programming
- > Software updates
- > Access to latest technical documentation

## Dealer Diagnostics Made Easy

### DA1869

#### Pathfinder & SDD VCI Package

Covers all JLR vehicles from 2005 - 2017 and works with all current & future DOIP vehicles from 2017 onwards

- > 1 x New JLR Pathfinder
- > 1 x New JLR SDD VCI
- > 1 x Panasonic CF-54 – Refurbished, with Windows 10 Pro, 8GB RAM and 480GB SSD
- > Pre-loaded with SDD and Pathfinder latest software
- > 2-year warranty
- > Online training
- > Guidance given for security application for security related tasks such as key and BCM programming and all other security related tasks.
- > Support contract available for software and hardware

For more details on the JLR packages email [britpart@maverickdiagnostics.com](mailto:britpart@maverickdiagnostics.com)

Or visit [www.maverickdiagnostics.com](http://www.maverickdiagnostics.com)

Ongoing costs: From JLR TOPIx website - hourly, daily, monthly, yearly rates available

# Maverick

## DIAGNOSTICS

### Support from Maverick

#### Dealer Tool Support From The Maverick Help Desk

[britpart@maverickdiagnostics.com](mailto:britpart@maverickdiagnostics.com)  
Our Dealer Tool Support is a proactive technical support service that Independent Workshops can subscribe to for assistance with OEM software and hardware. OEM Software is forever evolving and changing, and our team of skilled technicians are here to help you navigate those changes.

#### What Is Included In The Subscription?

A subscription to this service includes assistance with the following:

- > Unlimited access to our software loading service
- > 9-5 Mon-Fri access to our technical team
- > OEM software & hardware guidance
- > OEM software & hardware support

#### Vehicle Technical Support (VTS)

A subscription to Maverick Diagnostics Vehicle Technical Support (VTS) gives you access to over 70 Support Technicians with 15+ years of experience with all makes and brands. We will find the repair solution with you, saving you time and resources. We are the extra technician in your team.

#### What Is Included In The Subscription?

- > 10 live technical support tickets every month to access a team of 70 technicians.
- > Your ticket will not be closed until a repair solution is found.
- > Unlimited access to an online portal of 1.3 million known and verified repairs
- > End-to-end vehicle support and accurate technical data



DA1869

### DA3555 NEW

#### DOIP D-PDU & SDD VCI Package

Works with all current & future DOIP vehicles from 2017 onwards

- > 1 x New DOIP D-PDU VCI
- > 1 x New SDD VCI
- > 1 x Panasonic CF-D1 Tablet – Refurbished, with Windows 10 Pro, 8GB RAM and 480GB SSD
- > Pre-loaded with SDD and Pathfinder latest software
- > 2-year warranty
- > Online training
- > Guidance given for security application for security related tasks such as key and BCM programming and all other security related tasks.
- > Support contract available for software and hardware

#### DOIP D-PDU Interface

- > The D-PDU is a cost-effective alternative to the JLR Pathfinder VCI. It is fully DOIP compliant with Pathfinder software and has been tested thoroughly by the Maverick technical team and JLR customers over a period of 18 months.
- > Designed to work with Jaguar Land Rover Pathfinder software.
- > Covers DOIP, CAN, and Multi-CAN systems.
- > The D-PDU does not support older ISO9141, J1850 PWM protocols.
- > Does not cover FEPS programming voltages found on older vehicles.



DA3555



*Access To Latest  
Technical Documentation*

### Training from Maverick

#### JLR SDD & TOPIx Cloud Dealer Tool Training - 2 Day Course

Our JLR SDD and TOPIx Cloud dealer tool training course is delivered by highly qualified technicians. Places on this course are strictly limited in order to ensure high-quality training and maximise time getting to know the system and working on JLR-specific vehicles.

Our JLR dealer diagnostic tool training course shows you how to use your JLR tool and get hands-on training in our classroom & workshop with a JLR-specific vehicle. Our trainers will show you how to operate the tool and demonstrate its capabilities and functions, meaning you can add value to your business by using the tool effectively.

#### IMI Electric/Hybrid Vehicle System Repair & Replacement Levels 2.2 & 3 - 2 Day Course

This is a nationally recognised qualification. The content of this qualification has been designed to give the learners the knowledge and skills required to work safely on Electric/Hybrid vehicles whilst carrying out diagnostic, testing and repair activities. This may include vehicles that may have or had damage to their high energy/electrical system.





DA1864



DA1863



DA1862



*Ideal for use with Pathfinder Diagnostics*

*Suitable for most common battery types*

### DA1864

#### 50A Traction Control Battery Charger

The new MPL50 charger from Traction Chargers has been designed with the latest JLR workshop standards in mind. Suitable for most common battery types - Ca/Ca, Ca/Ag, AGM, GEL and conventional lead acid. The MPL50 features Traction's patented de-sulphation technology ensuring the battery is in peak condition before commencing charge. As with all Traction Battery Chargers the MPL50 is manufactured at our own UK site. The rectified DC output of the MPL50 achieves significantly higher standard of charge than its switched mode competitors.

- > Patented sulphation recovery program
- > Short circuit shut-down without blown fuse
- > Reverse polarity protection
- > Soft start current control
- > Fast constant current bulk charge
- > 3-stage charging: CI-CV-Float
- > Constant voltage float/standby
- > Proportional timing - minimal gas emission
- > Independent overrun timer
- > Accurate zero-crossing voltage sensing
- > Flexibility - to match battery specification
- > 50A constant output function for diagnostic support
- > Approved by Jaguar & Land Rover
- > Fitted with UK electric plug - adaptor needed for other countries

Input - 220-250VAC

Size - 380 x 260 x 255mm / Weight - 23kg

### DA1863

#### 125A Traction Control Battery Support Unit - Diagnostics, Reprogramming, ABS Brake Bleeding

BSU2-125B provides a stable voltage and up to 50 amps of fully regulated power to prevent loss of charge and damage to the battery. BSU2-125B can be used with any 12V automotive battery including AGM and GEL. When the battery is charged the BSU is a regulated power supply to sustain accessory loads and offset parasitic drain. Designed for use in the workshop and compatible with most diagnostic trolleys. Reverse polarity protection. Output current display. Supplied with 5M IEC power lead and 5M output leads.

- > BSU2-125B provides a constant voltage to prevent loss of data and possible damage to control units during software updates, and module reprogramming as well as diagnostic processes when in a Key On, Engine Off state
  - > During diagnostic or programming operations, the vehicle's systems are operating solely from the battery. Maintaining battery charge during this process is critical
  - > The status of BSU2-125B is indicated simply by three LED's - POWER, POLARITY, DEMAND. When all 3 are illuminated, BSU2-125B is supporting the battery
  - > Designed to be wall, ramp or trolley mounted the BSU2-125B has been designed to meet the needs of the high power consuming vehicle
  - > Approved by Jaguar & Land Rover
- Input - 90 - 260VAC  
Output - 13.4V up to 125A continuous  
Size - 300 x 184 x 124mm / Weight - 8kg

### DA1862

#### 50A Traction Control Battery Support Unit - Diagnostics, Reprogramming, ABS Brake Bleeding

BSU2-50 provides a stable voltage and up to 50 amps of fully regulated power to prevent loss of charge and damage to the battery. BSU2-50 can be used with any 12V automotive battery including AGM and GEL. When the battery is charged the BSU is a regulated power supply to sustain accessory loads and offset parasitic drain. Designed for use in the workshop and compatible with most diagnostic trolleys. Reverse polarity protection. Output current display. Supplied with 5M IEC power lead and 5M output leads.

- > This low profile (90mm) BSU2-50 battery support unit provides a constant voltage to prevent loss of data and possible damage to control units during software updates, and module reprogramming as well as diagnostic processes when in a Key On, Engine Off state
  - > During diagnostic or programming operations, the vehicle's systems are operating solely from the battery. Maintaining battery charge during this process is critical
  - > Designed to be wall, ramp or trolley mounted the BSU2-50 has been designed to meet the needs of the high power consuming vehicle
  - > Supplied with 5M output leads as standard
- Input - 100 - 240VAC / 50/60Hz  
Output - 13.4V up to 50A continuous  
Size - 280 x 190 x 90mm / Weight - 6kg





# REPAIR & SERVICE

New Or Old...  
We've Got The  
Parts For It!



### Air Suspension Compressors



LR023964

Discovery 3 - up to 9A513325  
Range Rover Sport - up to 9A215622  
DA3965

Complete Hitachi compressor kit

LR023964

Hitachi compressor & relay

LR023964G

Hitachi compressor & genuine LR relay

Range Rover L322 - from 6A198058 up to CA393639

LR025111

Hitachi compressor & relay

DA3964

Hitachi compressor pipe/install kit



LR078650

Full details on these compressors can be found in the Suspension section.

Discovery 3

Discovery 4

Range Rover Sport - Mk1

LR072537

Complete AMK compressor kit

LR078650

AMK compressor, relay, bracket & fixings

LR044034

Bracket only

DA1888

AMK compressor pipe/install kit



LR041777C

Discovery 4

Range Rover Sport - Mk1 - 2010 - 2013

LR038148G

AMK compressor & relay

Range Rover L322

LR041777C

AMK compressor & relay

Note - Only compatible with factory fitted AMK units.

LR041777G

OE AMK full compressor kit & relay



LR088859G

Range Rover Sport - Mk2

Range Rover L405

LR088859G

AMK compressor, relay & filter

LR108984G

AMK compressor, relay, filter, bracket, covers & wires

Defender - 2020 onwards/Discovery 5

Range Rover Velar/ Range Rover - 2013/ Range Rover Sport - 2014

LR140034G NEW

AMK compressor

### Front Hub, Bearing & Upright Assemblies



Freelander 2

Replacement front hub, bearing & upright complete assembly. Offers a quick and cheaper alternative to replacing wheel bearing or hub as separate items, saving time and money.

DA1213 Right hand side

DA1214 Left hand side



### Steering Rack Ball Joint Repair Kits



LR010673

LR010673

M14 ball joints

Range Rover Sport

- 2005 - 2013

LR010674

M12 ball joints

Range Rover Sport - 2005 - 2009

### Swivel Pin Kits



DA2178

DA2211

532268 Series 2 - conversion

532268G Series 2 - conversion

NEW OEM bearings

DA2178 Series 3

DA2211 Defender - up to KA930455

DA2210 Defender - from LA930456 up to WA159806

### Suspension Ball Joint Repair Kits

Suspension arm not included.



Using these replacement ball joint kits is a cost effective way to repair the Freelander front suspension arm.

RBJ102920/930BJ

Freelander 1 - up to 5A999999

RBJ500680/690BJ

RBJ500680/690BJG - OEM

Freelander 1 - from 6A000001

RBJ500680/690BJG

LR007205-6BJ

RBJ102920/930BJG

LR007205-6BJ

LR007205-6BJG - OEM

Freelander 2

Ball joint for LR007205 & LR007206

### Suspension Bolt Kits

Front Suspension

DA7202

Defender - up to KA930455

Radius arms & panhard rod bolts

DA7200

Defender - LA930456 to WA159806

Radius arms & panhard rod bolts

DA7203

Defender - XA159807 to 2A626645

Radius arms & panhard rod bolts

DA7204

Defender - 2A625546 onwards

Radius arms & panhard rod bolts

Rear Suspension

DA7201

Defender - up to YA185790

Trailing arms & a-frame bolts

DA7208

Defender - YA185791 onwards

Trailing arms & a-frame bolts

Front Suspension

DA7212

Discovery 3/Discovery 4

Range Rover Sport - 2005 - 2012

Upper suspension arm

Single

DA7205

Discovery 3/Discovery 4

Range Rover Sport - 2005 - 2012

Lower suspension arm

Single

Note - This kit includes a 1.5mm pitch threaded nut, please check the thread pitch on your drive shaft before changing. If you require the 2mm pitch nut please order LR024151.

Rear Suspension

DA7207

Discovery 3/Discovery 4

Range Rover Sport - 2005 - 2012

Upper suspension arm

Single

DA7206

Discovery 3/Discovery 4

Range Rover Sport - 2005 - 2012

Lower suspension arm

Single

### Stub Axle Kits

Front Kits

DA3190 Defender - up to KA

DA3191 Defender - from LA

DA3192 Defender - from 2007 onwards

DA3193 Discovery 1 - up to JA032850

DA3194 Discovery 1 - from JA032851

DA3195 Range Rover Classic - from JA624517



DA3191

Rear Kits

DA3198

Defender 90 - from LA930456

Defender 110 - from WA769311

DA3199

Defender - 110/130 from LA

with Salisbury axle up to WA769310

DA3358

Defender - up to KA. Up to axle 22S8283

DA3359

Defender - up to KA. From axle 22S8283

DA3196

Discovery 1 - up to JA032850

Range Rover Classic - up to JA032850

DA3197

Discovery 1 - from JA032851

Range Rover Classic - from JA032851

FTC1740G

Defender

1987 - 2006

Rear axle stub with Corteco seal



### Swivel Oil Seal Retainers



FRC4142SS

RRY500180SS

FRC4142SS

Defender/Discovery 1/Range Rover Classic

RRY500180SS

24 spline Defender/Discovery 1/Range Rover Classic

**Wheel Hub Assemblies**



**LR014147**  
Wheel hub & bearing assembly kit  
Front  
Discovery 3/Discovery 4  
Range Rover Sport - 2005 - 2013



**DA1388G**  
**NEW**  
Wheel hub & bearing  
- OEM bearing & seals  
**576844** Wheel hub only  
Series 2A - from suffix H  
Series 3 - up to Sept 1980  
**DA1389** Wheel hub & bearing  
**FRC3875** Wheel hub only  
Series 3 - All from October 1980 onwards  
Series 3 - All V8



**TAY100050L**  
**Discovery 2 Long Sensor Lead**  
**TAY100060L** Front  
**TAY100050L** Rear  
Land Rover recognised that on some Discovery 2 vehicles the wiring from the ABS sensor to the ECU could get damaged. This would result in the vehicle recording ABS faults that cannot be corrected by either a sensor or hub replacement. Their solution was to produce a sensor with a very long lead that bypassed the damaged lead. This hub assembly is a complete unit with this type of ABS sensor and lead.

**Power Steering Rack Pipes**

**DA2848**  
Discovery 3  
Discovery 4  
Pair

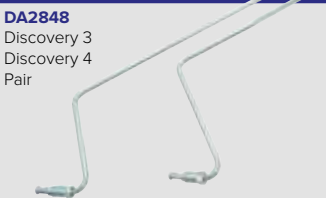

Fit to the steering rack and carry the fluid across the rack. Made from steel pipe and feature flared ends and zinc plated male nuts (we advise that customers apply additional corrosion protection before fitting). 6mm in diameter and are not to be confused with the feed and return hoses.

**Wheel Bearing Kits**

*Have all the parts required to hand!*



**RTC3534G**  
Britpart Kits  
**RTC3534** Series 2/Series 3 - SWB/LWB up to 1980 - imperial  
**RTC3537** Series 3 - SWB/LWB - 1980 onwards - metric  
**DA2379** Defender - up to KA  
**DA2380** Defender - up to KA  
**DA2381** Defender - LA onwards  
**DA2382** Discovery 1 - up to JA032850  
**DA2383** Discovery 1 - JA032851 onwards  
**DA2387** Range Rover Classic - ABS  
**DA2388** Range Rover Classic - non-ABS  
**DA2385** Range Rover Classic - non-ABS - up to JA624516  
**DA2384** Range Rover Classic - non-ABS - JA624517 onwards  
**DA2386** Range Rover Classic - ABS  
**FTC1507** Range Rover P38



**DA2379**  
Series 2/Series 3 - SWB/LWB up to 1980 - imperial  
Front & rear



**DA2387**  
Defender - up to KA  
Front

Britpart Kits	OEM Kits	Series	Location
<b>RTC3534</b>	<b>RTC3534G</b>	Series 2/Series 3 - SWB/LWB up to 1980 - imperial	Front & rear
<b>RTC3537</b>	<b>RTC3537G</b>	Series 3 - SWB/LWB - 1980 onwards - metric	Front & rear
<b>DA2379</b>	<b>DA2379G</b>	Defender - up to KA	Front
<b>DA2380</b>	<b>DA2380G</b>	Defender - up to KA	Rear
<b>DA2381</b>	<b>DA2381G</b>	Defender - LA onwards	Front & rear
<b>DA2382</b>	<b>DA2382G</b>	Discovery 1 - up to JA032850	Front & rear
<b>DA2383</b>	<b>DA2383G</b>	Discovery 1 - JA032851 onwards	Front & rear
<b>DA2387</b>	<b>DA2387G</b>	Range Rover Classic - ABS	Front
<b>DA2388</b>	<b>DA2388G</b>	Range Rover Classic - non-ABS	Front
<b>DA2385</b>	<b>DA2385G</b>	Range Rover Classic - non-ABS - up to JA624516	Rear
<b>DA2384</b>	<b>DA2384G</b>	Range Rover Classic - non-ABS - JA624517 onwards	Rear
<b>DA2386</b>	<b>DA2386G</b>	Range Rover Classic - ABS	Rear
<b>FTC1507</b>		Range Rover P38	Front & rear

**Note** - Bearing only

**Steering Box/Rack Repair Kits**



**DA1236**  
Series 2, 2A & 3



**DA2947 NEW**  
Discovery Sport - early models  
Range Rover Evoque - 2011 - 2018  
Early Range Rover Evoque & Discovery Sports had steering racks held together with aluminium bolts. These can fail and leave the vehicle with no steering. This kit comprises three upgraded steel bolts together with a new drive belt for the power assistance. None of the kit items are available from Land Rover.

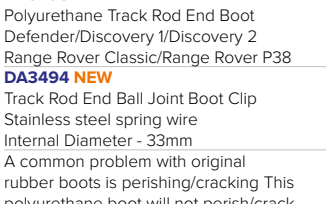

Photo by Serjan Midill

**Polyurethane Boots & Clips**



**DA3493 NEW**  
Polyurethane Track Rod End Boot  
Defender/Discovery 1/Discovery 2  
Range Rover Classic/Range Rover P38



**DA3494 NEW**  
Track Rod End Ball Joint Boot Clip  
Stainless steel spring wire  
Internal Diameter - 33mm  
A common problem with original rubber boots is perishing/cracking. This polyurethane boot will not perish/crack like normal rubber so will give you a much longer service life. The boots are double convoluted which allows them to move/flex more without stretching.



**DA3497 NEW**  
Polyurethane A-frame Ball Joint Boot  
Defender/Discovery 1/Range Rover Classic

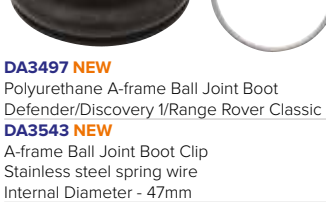

**DA3543 NEW**  
A-frame Ball Joint Boot Clip  
Stainless steel spring wire  
Internal Diameter - 47mm



### Brake Pipe Sets



**Easily fitted**  
**Will not rust**

**DA7417**

Copper nickel brake pipe sets manufactured in the UK. Each kit is complete for a specific Land Rover model. Pipes are cut to the correct length, fitted with solid brass unions and marked clearly to indicate the correct location on the Land Rover. Pipe fitting clips and brass in-line connectors are supplied where necessary.

More brake pipe kits available on request.



**DA7440**  
Brake pipe bending tool. Can be used with all the brake pipe kits.

<b>DA7443</b>	Series 1		RHD	80 inch
<b>DA7442</b>	Series 1		RHD	86 inch
<b>DA7400</b>	Series 2	SWB	RHD	1958 - 1961. From 141900105 to suffix F inclusive 4-cylinder
<b>DA7428</b>	Series 2	SWB	LHD	1958 -1969 suffix F. 4-cylinder from 141900105 to suffix F
<b>DA7401</b>	Series 2A	SWB	RHD	4-cylinder up to 1969 suffix G
<b>DA7429</b>	Series 2A	SWB	LHD	1969 4-cylinder to suffix G
<b>DA7402</b>	Series 2A	LWB	RHD	09/1961 - 01/1969 4-cylinder up to suffix F
<b>DA7405</b>	Series 2A	LWB	RHD	6-cylinder with servo up to 1969 to suffix F
<b>DA7406</b>	Series 2A	LWB	RHD	From 04/1969 suffix G. No servo 6-cylinder from suffix G.
<b>DA7403</b>	Series 3	SWB	RHD	Single line 4-cylinder & 6-cylinder
<b>DA7407</b>	Series 3	SWB	RHD	Dual lightweight up to 07/1980
<b>DA7409</b>	Series 3	SWB	RHD	Dual to early 1980
<b>DA7412</b>	Series 3	SWB	RHD	Lightweight dual up to 1975 with servo to chassis 95102970A
<b>DA7413</b>	Series 3	SWB	RHD	Dual from 07/1980. Civilian body metric & imperial system
<b>DA7430</b>	Series 3	SWB	LHD	No servo
<b>DA7432</b>	Series 3	SWB	LHD	Dual system to early 1980
<b>DA7446</b>	Series 3	SWB	LHD	From July 1980
<b>DA7404</b>	Series 3	LWB	RHD	4-cylinder & 6-cylinder single line
<b>DA7408</b>	Series 3	LWB	RHD	From 07/1980 & air portable lightweight from July 1980 onwards & 1981 V8 dual
<b>DA7410</b>	Series 3	LWB	RHD	Up to 06/1980 dual. 4-cylinder up to 06/1980 & V8 up to 09/1980
<b>DA7431</b>	Series 3	LWB	LHD	Single line 4-cylinder & 6-cylinder
<b>DA7411</b>	Defender		90	RHD
<b>DA7418</b>	Defender		90	RHD
<b>DA7441</b>	Defender		90	RHD
<b>DA7439</b>	Defender		90	LHD
<b>DA7420</b>	Defender		110	RHD
<b>DA7414</b>	Defender		110	RHD
<b>DA7438</b>	Defender		110	RHD
<b>DA7357</b>	Defender		110	RHD
<b>DA7419</b>	Defender		130	RHD
<b>DA7415</b>	Discovery 1	200Tdi	RHD	Up to VIN JA 1992
<b>DA7417</b>	Discovery 1	300Tdi	RHD	From 1994 non-ABS
<b>DA7433</b>	Discovery 1	300Tdi	LHD	From 1994 with ABS
<b>DA7422</b>	Range Rover Classic		RHD	Early models
<b>DA7421</b>	Range Rover Classic		RHD	From 1979 with rear valve
<b>DA7423</b>	Range Rover Classic		RHD	Non-ABS from 1987 VIN DA274121 (2-door) & DA273923 (4-door) OSF valve
<b>DA7425</b>	Range Rover Classic		RHD	ABS 1990 - 1991 VIN HA
<b>DA7426</b>	Range Rover Classic		RHD	ABS 1992 VIN JA
<b>DA7427</b>	Range Rover Classic		RHD	1993 VIN KA air suspension
<b>DA7424</b>	Range Rover Classic		RHD	ABS 1986 up to VIN CA274120 (2-door) & CA273922 (4-door) front valve & bypass pipe
<b>DA7434</b>	Range Rover Classic		LHD	From 1979 with rear valve
<b>DA7435</b>	Range Rover Classic		LHD	From 1987 non-ABS from VIN DA274121 (2-door) & DA273923 (4-door) front valve & bypass pipe
<b>DA7436</b>	Range Rover Classic		LHD	ABS front valve & bypass pipe 1986. 1983 up to VIN CA274120 (2-door) & CA273922 (4-door) 1986 onwards
<b>DA7437</b>	Range Rover Classic		LHD	Up to 1992 VIN HA with Clayton Dewandre Wabco 4-channel ABS

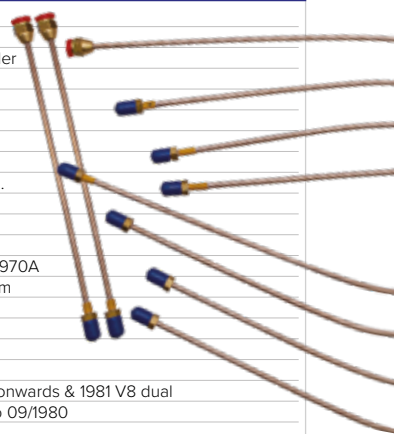

*Ready Made Brake Pipe Sets*

### Anti-squeal Shims



**DA1141**  
Universal self adhesive noise dampening shims. Pack of 4. The shims are manufactured from wolverine and cut to shape and applied to the backing plate of the brake pads prior to fitting to help eliminate any noise issues (should the pad be unshimmed). When used in conjunction with Mintex Cera-Tec silicon based lubricant, most brake noise related issues will be eradicated.

### Parking Brake Spring Kits

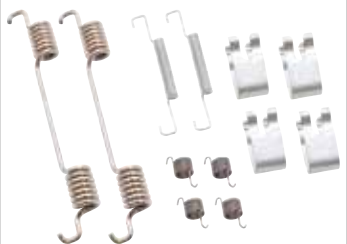

**LR031947KIT**  
Discovery 4  
Range Rover Sport - 2010 - 2013

**SFS500012KIT**  
Discovery 3/Discovery 4  
Range Rover Sport - 2005 - 2013

**LR031947KIT**

### Brake Caliper Pin Kit



**LR016683G**  
Range Rover Sport - 2010 - 2013 & 2014 onwards  
Range Rover L322 - 2010 - 2012/Range Rover L405  
Models fitted with front Brembo brake calipers tend to suffer from the steel pins seizing in the aluminium caliper. The pins are often destroyed whilst being removed. This is a handy new pin kit for both front calipers.

### Brake Caliper Pistons & Kits - Stainless Steel

#### Stainless Steel Brake Caliper Piston Kits

Each kit is one complete axle, either front or rear as stated. The kit includes OEM repair kit and grease sachet.

<b>DA1165</b>	Defender 90 - up to HA701009/Discovery 1/Range Rover Classic	Front
<b>DA1166</b>	Defender 110 - up to HA701009/Defender - HA701010 onwards	Front
<b>DA1167</b>	Defender - 90/Discovery 1/Range Rover Classic	Rear
<b>DA1172</b>	Defender - 110/130	Rear

#### Single Stainless Steel Pistons

<b>606683S</b>	Defender - up to HA701009/Discovery 1/Range Rover Classic	Front
<b>606696S</b>	Defender - 90/Discovery 1/Range Rover Classic	Rear
<b>STC201S</b>	Defender - HA701010 onwards	Front
	Defender - 110/130	Rear

**DA1165**



### Brake Kits



**DA6042**

Kits include - Brake shoes, wheel cylinders, brake springs & screws (where applicable)

	Britpart Kit	OEM Kit
Rear	<b>DA6507</b>	<b>DA6507G</b>
	90 - up to HA701009	
Rear	<b>DA6508</b>	<b>DA6508G</b>
	90 - HA701010 onwards	
Rear	<b>DA6509</b>	<b>DA6509G</b>
	110/130 - up to KA930545	
<b>Series - SWB</b>		
Front	<b>DA6042</b>	<b>DA6042G</b>
	Up to June 1980	
Rear	<b>DA6043</b>	<b>DA6043G</b>
	Up to June 1980	
Rear	<b>DA6044</b>	<b>DA6044G</b>
	July 1980 onwards	
Front	<b>DA6046</b>	<b>DA6046G</b>
	July 1980 onwards	
<b>Series - LWB</b>		
Front	<b>DA6044</b>	<b>DA6044G</b>
	4 cylinder except 1 ton	
Front	<b>DA6045</b>	
	6 cylinder & 109 V8 Stage 1	
Front	<b>DA6047</b>	<b>DA6047G</b>
Rear	Including V8	

### Brake Fitting Kit

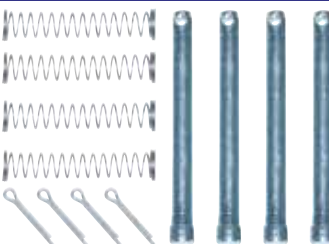

**DA4105**  
Defender - 1987 - 2006  
Brake fitting kit for rear brake pads STC1601 & SFP000280

### Parking Actuator Repair Kit



**DA9223**  
Discovery 3  
Discovery 4  
Range Rover Sport - 2005 - 2009  
Kit to fix the troublesome parking brake actuator - LR019223

**DA9223**  
Fixing kit which includes -  
4 x gears  
8 x self-tap Torx screws  
2 x hex bobbins  
4 x Durlock flange nuts  
**DA9224**  
Set of 4  
Replacement brake actuator gears

### Brake Lubrication

**DA2389**  
**Cera-Tec Advanced Lubricant**  
75ml  
Mintex Cera-Tec is an advanced non-metallic universal lubricant that provides many benefits over traditional copper-based grease.



- > Non-metallic content - ABS and ESP friendly.
- > Operates to a high temperature (1,000°C).
- > Non-conductive.
- > Free of copper and acid.
- > More effective at reducing any brake squeal.
- > Protects against corrosion and dirt.
- > Neutral colour prevents any visible residue or staining.

Britpart XS Brake Discs

# XS Brake Disc



Model	Year Range	Position	Type
<b>Range Rover Classic</b>			
LR017951G	1986 - 1991	Front	Solid
LR017952G	1986 - 1994	Front	Vented
LR017953G	1986 - 1994	Rear	Solid
<b>Range Rover P38</b>			
NTC8780G	1995 - 2002	Front	Vented
SDB000470G	1995 - 2002	Rear	Solid
<b>Range Rover Sport</b>			
SDB000614G	2005 - 2009	Front	Vented
SDB000604G	2005 - 2009	Front	Vented
SDB000624G	2005 - 2013	Front	Vented
LR025946G	2010 - 2013	Front	Vented
SDB000646G	2005 - 2013	Rear	Vented
SDB000636G	2005 - 2009	Rear	Vented
LR016192G	2010 - 2013	Rear	Vented
LR016176G	2014 onwards	Front	Vented
LR038934G	2014 onwards	Front	Vented
LR033303G	2014 onwards	Rear	Vented
LR033302G	2014 onwards	Rear	Vented
LR161899G NEW	2014 onwards	Rear	Vented
LR161898G NEW	2014 onwards	Rear	Vented
<b>Range Rover L322</b>			
SDB000201G		Front	Vented
SDB500182G		Front	Vented
LR031843G		Front	Vented
LR031845G		Front	Vented
SDB000211G		Rear	Solid
LR031844G		Rear	Vented
LR016176G	2010 - 2012	Front	Vented
LR031846G	2010 - 2012	Rear	Vented
<b>Range Rover L405</b>			
LR016176G		Front	Vented
LR038934G		Front	Vented
LR033303G		Rear	Vented
LR033302G		Rear	Vented
LR161899G NEW		Rear	Vented
LR161898G NEW		Rear	Vented
<b>Range Rover Evoque</b>			
LR007055G		Front	Vented
LR059122G	17" wheel	Front	Vented
LR027123G		Rear	Solid
LR072016G		Rear	Solid

Model	Year Range	Position	Type
<b>Defender</b>			
LR017951G	1987 - 2006 & 2007 onwards	Front	Solid
LR017952G	1987 - 2006 & 2007 onwards	Front	Vented
FTC3846G	1987 - 2006	Rear	Solid
LR017953G	1987 - 2006 & 2007 onwards	Rear	Solid
LR018026G	1987 - 2006 & 2007 onwards	Rear	Solid
LR161899G NEW	2020 onwards	Rear	Vented
<b>Discovery 1</b>			
LR017951G		Front	Solid
LR017952G		Front	Vented
LR017953G		Rear	Solid
<b>Discovery 2</b>			
SDB000380G		Front	Vented
SDB000470G		Rear	Solid
<b>Discovery 3</b>			
SDB000614G		Front	Vented
SDB000604G		Front	Vented
SDB000646G		Rear	Vented
SDB000636G		Rear	Vented
<b>Discovery 4</b>			
SDB000624G		Front	Vented
SDB000604G		Front	Vented
LR025946G		Front	Vented
SDB000646G		Rear	Vented
SDB000636G		Rear	Vented
<b>Discovery 5</b>			
LR161898G NEW		Rear	Vented
LR161899G NEW		Rear	Vented
<b>Discovery Sport</b>			
LR059122G		Front	Vented
LR007055G		Front	Vented
LR061388G		Rear	Solid
<b>Freelander 1</b>			
SDB100830G	Up to YA999999	Front	Solid
SDB101070G	1A000001 onwards	Front	Vented
<b>Freelander 2</b>			
LR027107G	Petrol	Front	Vented
LR001019G	Petrol	Rear	Vented
LR007055G	Diesel	Front	Vented
LR001018G	Diesel	Rear	Solid
LR039935G	From DH000001	Rear	Solid

Exact OEM Specification

Low Noise



- > Installation ready - no need for cleaning before use
- > Anti-corrosion coating which provides a long lasting clean appearance, ideal for today's open rims
- > Disc run out - ≤0.08mm
- > Unbalance requirement - ≤150g.cm
- > Coating - 5\*20µm NA paint
- > Salt spray test - 120 hours

Girling Classic Brake Caliper Repair Kits



STC1270GIRLING

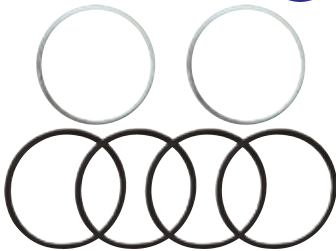

AEU2539GIRLING NEW

Front 110 & 90 - from HA701010

STC1270GIRLING NEW

Rear 110 - up to 1A614447

SMN000060GIRLING NEW

Rear 110 - from 1A614448

Girling Classic Brake Hoses

219824GIRLING	Series 1 - 1948 - 1953	Front
RTC3386GIRLING	Series 1, Series 2 & Series 2A Short & long wheel base - 1954 - 1971	Front
RTC5903GIRLING	Series 3 - Short & long wheel base - 1971 - 1980	Front
577681GIRLING	Series 3 - 1 Ton - 1971 - 1980	Front
NRC9457GIRLING	Series 3 - Short & long wheel base - 1980 - 1984	Front
219824GIRLING	Series 1 - 1948 - 1953	Rear
RTC3386GIRLING	Series 1, Series 2, Series 2A & Series 3 Short wheel base - 1954 - 1980	Rear
RTC3353GIRLING	Series 3 - Long wheel base - 1971 - 1980	Rear
NRC9458GIRLING	Series 3 - Short wheel base - 1980 - 1984	Rear
NRC4402GIRLING	Series 3 - Long wheel base - 1980 - 1984	Rear



219824GIRLING

NRC9457GIRLING





### Britpart XD & Britpart XS Brake Pads

#### XD Brake Pads XS Brake Pads

SFP000280	SFP000280G	Defender - 1987 - 2006	Rear
SFP000260	SFP000260G	Defender - 1987 - 2016	Front
SFP000250	SFP000250G	Defender - 1987 - 2016	Rear
LR032954	LR032954G	Defender - 2007 - 2016	Rear
LR138646	LR138646G	Defender - 2020 onwards	Front
LR156926	LR156926G	Defender - 2020 onwards	Front
LR157174	LR157174G	Defender - 2020 onwards	Front
LR162045	LR162045G	Defender - 2020 onwards	Front
LR162042	LR162042G	Defender - 2020 onwards	Rear
LR162048 <b>NEW</b>	LR162048G <b>NEW</b>	Defender - 2020	Rear
SFP500160	SFP500160G	Discovery 1	Front
SFP500180	SFP500180G	Discovery 1	Front
SFP500190	SFP500190G	Discovery 1	Rear
SFP500200	SFP500200G	Discovery 1	Rear
SFP500220 <b>NEW</b>	SFP500220G	Discovery 1	Rear
SFP500150	SFP500150G	Discovery 2	Front
SFP500130	SFP500130G	Discovery 2	Rear
LR134694	LR134694G	Discovery 3	Front
LR134696	LR134696G	Discovery 3	Rear
LR134694	LR134694G	Discovery 4	Front
LR134700	LR134700G	Discovery 4	Front
LR134696	LR134696G	Discovery 4	Rear
LR139969	LR139969G	Discovery 4	Rear
LR134644	LR134644G	Discovery 5	Front
LR138646	LR138646G	Discovery 5	Front
LR156926	LR156926G	Discovery 5	Front
LR157174	LR157174G	Discovery 5	Front
LR162042	LR162042G	Discovery 5	Rear
LR160540	LR160540G	Discovery Sport	Front
LR164029	LR164029G	Discovery Sport	Front
LR160486 <b>NEW</b>	LR160486G <b>NEW</b>	Discovery Sport	Front
LR160435 <b>NEW</b>	LR160435G <b>NEW</b>	Discovery Sport	Front
LR061385	LR160436G	Discovery Sport	Rear
	LR160458G	Discovery Sport	Rear
LR160458	LR160458G	Discovery Sport	Rear
LR160459	LR160459G	Discovery Sport	Rear
LR160460	LR160460G	Discovery Sport	Rear
LR160504	LR160504G	Discovery Sport	Rear
LR021899	LR021899G	Freelander 1	Front
SFP100360	SFP100360G	Freelander 1	Front
LR134692	LR134692G	Freelander 2	Front
LR134695	LR134695G	Freelander 2	Rear
LR134697	LR134697G	Freelander 2	Rear
LR165293 <b>NEW</b>	LR134697G	Freelander 2	Rear
SFP500180	SFP500180G	Range Rover Classic - 1986 - 1994	Front
SFP500200	SFP500200G	Range Rover Classic - 1986 - 1994	Rear
SFP500120	SFP500120G	Range Rover P38	Front
SFP500130	SFP500130G	Range Rover P38	Rear

#### XD Brake Pads XS Brake Pads

LR134694	LR134694G	Range Rover L322 - 2002 - 2009	Front
SFC500080	SFC500080G	Range Rover L322 - 2002 - 2009	Front
LR148353 <b>NEW</b>	LR148353G <b>NEW</b>	Range Rover L322 - 2002 - 2009	Front
LR026221	LR026221G	Range Rover L322 - 2009 - 2012	Front
LR134696	LR134696G	Range Rover L322 - 2002 - 2009	Rear
SFP500210	SFP500210G	Range Rover L322 - 2002 - 2009	Rear
LR134882	LR134882G	Range Rover L322 - 2010 - 2012	Rear
LR139969	LR139969G	Range Rover L322 - 2010 - 2012	Rear
LR160069 <b>NEW</b>	LR160069G <b>NEW</b>	Range Rover L405	Front
LR134644	LR134644G	Range Rover L405	Front
LR134700	LR134700G	Range Rover L405	Front
LR138646	LR138646G	Range Rover L405	Front
LR156926	LR156926G	Range Rover L405	Front
LR160069 <b>NEW</b>	LR160069G <b>NEW</b>	Range Rover L405	Front
LR147981	LR147981G	Range Rover L405	Rear
LR162042	LR162042G	Range Rover L405	Rear
LR162046	LR162046G	Range Rover L405	Rear
LR162047	LR162047G	Range Rover L405	Rear
LR164821 <b>NEW</b>	LR164821G <b>NEW</b>	Range Rover L405	Rear
LR134694	LR134694G	Range Rover Sport - 2005 - 2009	Front
LR148353 <b>NEW</b>	LR148353G <b>NEW</b>	Range Rover Sport - 2005 - 2009	Front
LR134696	LR134696G	Range Rover Sport - 2005 - 2009	Rear
LR134700	LR134700G	Range Rover Sport - 2010 - 2013	Front
LR134882	LR134882G	Range Rover Sport - 2010 - 2013	Rear
LR139969	LR139969G	Range Rover Sport - 2010 - 2013	Rear
LR160069 <b>NEW</b>	LR160069G <b>NEW</b>	Range Rover Sport - 2014 onwards	Front
LR134644	LR134644G	Range Rover Sport - 2014 onwards	Front
LR134700	LR134700G	Range Rover Sport - 2014 onwards	Front
LR138646	LR138646G	Range Rover Sport - 2014 onwards	Front
LR156926	LR156926G	Range Rover Sport - 2014 onwards	Front
LR162044	LR162044G	Range Rover Sport - 2014 onwards	Front
LR160069 <b>NEW</b>	LR160069G <b>NEW</b>	Range Rover Sport - 2014 onwards	Front
LR147981	LR147981G	Range Rover Sport - 2014 onwards	Rear
LR162042	LR162042G	Range Rover Sport - 2014 onwards	Rear
LR162046	LR162046G	Range Rover Sport - 2014 onwards	Rear
LR162047	LR162047G	Range Rover Sport - 2014 onwards	Rear
LR164821 <b>NEW</b>	LR164821G <b>NEW</b>	Range Rover Sport - 2014 onwards	Rear
LR160438	LR160438G	Range Rover Velar	Front
LR160444	LR160444G	Range Rover Velar	Front
LR141734 <b>NEW</b>	LR141734G <b>NEW</b>	Range Rover Velar	Front
LR160437 <b>NEW</b>	LR160437G <b>NEW</b>	Range Rover Velar	Front
LR134709 <b>NEW</b>	LR134709G <b>NEW</b>	Range Rover Velar	Front
LR160511 <b>NEW</b>	LR160511G <b>NEW</b>	Range Rover Velar	Front
LR160458	LR160458G	Range Rover Velar	Rear
LR160532 <b>NEW</b>	LR160532G <b>NEW</b>	Range Rover Velar	Rear
LR160580 <b>NEW</b>	LR160580G <b>NEW</b>	Range Rover Velar	Rear
LR122689 <b>NEW</b>	LR122689G <b>NEW</b>	Range Rover Velar	Rear
LR134693	LR134693G	Range Rover Evoque - 2012 - 2018	Front
LR160435 <b>NEW</b>	LR160435G <b>NEW</b>	Range Rover Evoque - 2012 - 2018	Front
LR061385	LR134695G	Range Rover Evoque - 2012 - 2018	Rear
LR134695	LR134695G	Range Rover Evoque - 2012 - 2018	Rear
LR164029	LR164029G	Range Rover Evoque - 2019 onwards	Front
LR160486 <b>NEW</b>	LR160486G <b>NEW</b>	Range Rover Evoque - 2019 onwards	Front
LR160460	LR160460G	Range Rover Evoque - 2019 onwards	Rear
LR160504	LR160504G	Range Rover Evoque - 2019 onwards	Rear

#### IMPORTANT BRAKE INFORMATION

For exact change over points with vehicle applications please contact your local Britpart stockist with the full chassis number for the correct application. These references are intended as a guide only.



**Britpart XD Handbrake Shoes**

**XD Brake Shoes**

**LR031947**  
Discovery 4 - from BA583709  
Range Rover Sport - 2010 - 2013 - from BA701292  
**SFS000051**  
Range Rover L322  
**LR001020**  
Freelander 2

**SFS500012**  
Discovery 3  
Discovery 4 - from AA000001 to BA583709  
Range Rover Sport - 2005 - 2009  
Range Rover Sport - from AA000001 to BA701291

#### Brake & Clutch Reservoir Tanks



**271581**  
Series 1  
Brake fluid supply tank

**90577636GIRLING**  
Girling Classic brake fluid reservoir  
Series 3  
101 Forward Control

**504105G**  
Series 2/Series 2A  
Replacement combined brake and clutch reservoir serves both the brake and clutch master cylinders. An internal wall avoids a failure of both systems if one develops a leak. Reservoir is as per original design.

Britpart XD & Britpart XS Brake Pads

# XD Brake Pads

- > Manufactured to OEM specifications ensuring long life and low noise in a TS16949 & ISO14021 approved factory
- > Asbestos, lead & CR6 free material
- > The XD Brake Pad range meet all official legislation for quality and safety and are compliant with European ECE R90
- > All XD Brake Pads are produced with an underlayer material designed to dampen vibrations to prevent noise and to reduce heat transfer to the brake fluid

The Britpart range of XD Brake Pads gives you the opportunity of fitting a much higher quality brake pad than the price would indicate. Britpart has tested many different brake pads over the years and have found this brake pad specification offers Land Rover owners the best possible performance at this price level.

The XD Brake Pads are manufactured to an exact tolerance using only the best European friction materials to OEM specifications ensuring long life and low noise.

All raw materials are analysed in-house using a fully equipped quality laboratory with, for example, an atomic absorption device. After analysis the raw materials are mixed and pressed using several different methods to achieve the best brake pad for each application. Each part number is tailored to the application it is intended for.

The XD Brake Pad range has been thoroughly tested on dynamometers and noise measuring rigs before being put through their paces on test tracks and extended operations tests to ensure a perfect and effective operation every time. All pads are covered by the worldwide Britpart warranty and Britpart recommends they are fitted with the Britpart standard or performance brake discs.



# XS Brake Pads

**XS Brake Pads have the exact performance material specification of production line brake pads**

The Britpart range of XS Brake Pads offers you the opportunity to have the exact factory production line specification of brake pad at an affordable price.

These pads offer the best possible combination of long life, pedal feel and noise suppression. All the pads in the range use the same friction material specification that your Land Rover was originally made with.

The XS range of pads are all produced in one of the world's premium brake pad facilities where production procedures are carefully monitored to ensure a consistently good product. The facility has both in-house testing and access to OE testing facilities to ensure all pads meet the exact specification required. Britpart XS Brake Pads are ideal for high mileage or heavy-duty applications.

**Best possible combination of long life, pedal feel & noise suppression**

## Brembo Lightweight Brake Discs

LR161896G NEW	Defender - 2020 onwards	363mm	Single	Front
LR161901G NEW	Defender - 2020 onwards	325mm	Pair	Rear
LR132811G NEW	Defender - 2020 onwards	350mm	Pair	Rear
LR161895G NEW	Defender - 2020 onwards	349mm	Single	Rear
LR161907G NEW	Discovery Sport	325mm	Single	Front
LR161912G NEW	Discovery Sport	349mm	Single	Front
LR161918G NEW	Discovery Sport	300mm	Single	Rear
LR161919G NEW	Discovery Sport	325mm	Single	Rear
LR161896G NEW	Discovery 5	363mm	Single	Front
LR115005G NEW	Range Rover Evoque - 2019 onwards	325mm	Single	Front
LR161912G NEW	Range Rover Evoque - 2019 onwards	349mm	Single	Front
LR161918G NEW	Range Rover Evoque - 2019 onwards	300mm	Single	Rear
LR161919G NEW	Range Rover Evoque - 2019 onwards	325mm	Single	Rear
LR116911G NEW	Range Rover Velar	395mm	Single	Front
LR116914G NEW	Range Rover Velar	396mm	Single	Rear

Britpart is proud to be a Brembo Official Partner and we are delighted to now be able to offer the new Brembo Lightweight disc. This is a new addition to the Brembo Aftermarket range applicable for some of the latest generation Land Rover models.

Manufactured in the same plant and on the same assembly line as the OE, the disc is made up of a high-carbon cast iron braking surface and a steel hat, which are connected by mechanical interference.

These technical features allow for a weight reduction of up to 15% compared to its integral counterpart of the same size. Since the brake disc contributes to the unsprung mass of the vehicle, reducing the weight ensures an increase in the available force and therefore improves handling and reduces consumption and emissions of the vehicle.

Manufactured in the same plant and on the same assembly line as the OE



**official partner**

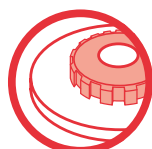

**LIGHTWEIGHT**



**ECE R 90**



**EQUIVALENT**





### Alternator Upgrade Kits



DA7195

200Tdi alternator upgrade kits  
Kits include uprated cable  
**DA1195** Defender - 200Tdi  
Upgrade the 45A alternator to 100A  
**DA7195 NEW** Defender - 200Tdi  
Upgrade the 45A alternator to 70A  
**DA1196** Discovery 1 - 200Tdi  
Upgrade the alternator to 100A

### Earth Lead



**575184 NEW**  
Series  
Earth lead gear box to chassis  
12 & 24 volt

### Distributor Cap



**RTC3278RED**  
Defender & Series

### Ignition Module & Link Lead



**STC1184K**  
Module for V8 distributor.  
Kit to convert 3-pin to 2-pin applications

### Key Fob Batteries



Single batteries for locking key fobs  
**STC1853**  
CR2025  
**YWK10003L**  
CR2032  
**YWK10005** CR1220

### Key Fob Repair Kit



**DA4696**  
Range Rover P38  
The buttons on a Range Rover P38 are prone to wearing out and becoming very tatty and unusable. Fix that problem with this handy repair kit.

### Battery-Guard

**DA1460**  
With the Battery-Guard and Apple or Android App, you can check your battery's state of charge quickly and easily. Because only with a fully charged vehicle battery can you be sure to avoid getting stuck. Compatible from iPhone 4S, Android 4.3 and Windows 10.

#### Features

- > Several vehicles can be monitored
- > Easy install to the battery
- > Monitoring of 6, 12 and 24 volt batteries possible
- > Power consumption is only about 6-24 MW
- > Reverse-polarity does not cause damage to the transmitter or battery
- > App compatible from iPhone 4S, Android 4.3 or Windows 10

*Easy install to the battery*

#### Easy to use

1. Download the Battery-Guard App
2. Connect the Battery-Guard & fix the transmitter
3. Activate Bluetooth
4. Monitor your batteries



*Battery monitoring via Bluetooth*

### Electronic Conversion Kits

**ETC5835K**  
Electronic conversion kit replaces the existing points and condenser with a new reliable electronic module. For 4-cylinder petrol engines the electronic ignition module has been developed to work with the standard ignition coil and provides service free and accurate ignition timing. The kit can be easily fitted to standard points type 45D4 distributors. We recommend fitting a new coil at the same time - PRC9858. Also available a new distributor with points to which this kit can be fitted - ETC5835.

#### ERC4536K

This electronic conversion kit is for V8 points and has built in dwell adjustment with rpm protection when not running.

**Note** - Both kits are for negative earth vehicles only.



ERC4536K

ETC5835K

### Ignition Lead Sets

**DA4102**  
**DA4102RED**  
Defender - 4.0 V8  
Range Rover P38 - V8 - up to 1999  
**DA4104**  
**DA4104RED**  
Discovery 1 - V8  
Range Rover Classic - V8  
**Note** - Includes king lead

Grey leads  
Red leads  
Grey leads  
Red leads

These silicone HT lead sets are designed to meet or exceed the original equipment specification. The silicone cable has minimal interference with maximum suppression, it is also resistant to water, oils, chemicals and high temperatures. High quality with ISO 3808 class noise suppression performance.

**STC9124**  
Discovery 1 - V8/Range Rover Classic - V8  
King lead with protective & waterproof rubber coil cover  
**RTC6551**  
**RTC6551RED**  
Defender - 3.5 V8  
Discovery 1 - 3.5 V8 carb & 3.5 V8 Efi  
Range Rover Classic - 3.5 V8 carb  
Range Rover Classic - 3.5 V8 Efi  
**Note** - Includes king lead

Grey lead  
Grey leads  
Red leads

**NGC103740/810**  
**NGC103740/810RED**  
Range Rover P38  
Discovery 2 - 1999 onwards  
**DA5684**  
Range Rover P38 - 4.6 V8 1994 - 1998  
**NGC500370/410**  
Freelander 1 - 1.8K

Grey leads  
Red leads  
Grey leads  
Red leads

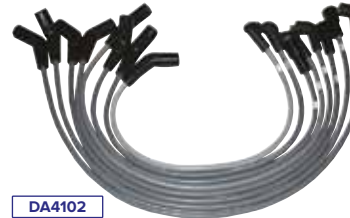

DA4102



DA5684

### Starter Motor Repair Kit for NAD101240



**DA5240**  
Defender - Td5  
Discovery 2 - Td5  
Starter motor repair kit for genuine Land Rover NAD101240LR & Denso NAD101240G.  
Not suitable for aftermarket starter motors.

### Actuator Repair Cog



**LR108980COG**  
Soft door close power lock latch actuator cog for LR108980  
Front  
Range Rover L405  
Range Rover Sport - Mk2

### Electronic Distributors



**ETC5835ERED** Red top  
**ETC5835EBLACK** Black top  
Series - 2.25 petrol  
Defender - 90/110  
- 2.5l 4-cyl petrol - 1985 - 1994  
**Note** - Negative earth vehicles only.  
Distributor with electronic conversion fitted which replaces the existing points & condenser with a new reliable electronic module.

STC9124



NGC500370/410

### Otter Switch Upgrade



**545010 NEW**  
Series 2/2A & 3  
An updated and reproduced engine mounted switch for operating the choke warning light.  
> Waterproof  
> Max current capacity - 1 amp  
> Normally open  
> Single spade lug connection (body of switch is earth)  
> Supplied with new cork gasket

**Programmable Wiper Relay**

**AMR2341DELAY**

*Fed up with your Defender's intermittent wipers not being intermittent enough? Does it drive you mad when you give the screen a quick spray and it wipes for ages?*

Fit this new relay in place of the standard AMR2341 to your vehicle to solve this problem. Once fitted you press the stalk down so that the wiper wipes and then back off again, now count/wait till you want another wipe, switch the stalk down and leave it on, this timing will now remain constant till you set another timing the same way or turn off the ignition at which point the relay reverts to a standard 6 second wipe interval. Another bonus is that the wipers will now only wipe once following a short burst of washer fluid or 3 times after a long burst. This will work on all Defenders with the latching intermittent wiper stalk PRC7370 or AMR6106 HA onwards (stays down when pressed) but it will also work on 300Tdi and Td5 although on post 2002 Td5s the relay AMR2341 is located behind the speedo. Will not work with early stalk PRC3900 up to GA models.



**Replacement Batteries**



	Capacity	CCA*
LR047630	15Ah	200
STC4757	70Ah	500
YGD500100	70Ah	640
LR094611	70Ah	760
LR038128	80Ah	770
LR072855	95Ah	855
LR038341	95Ah	855
LR094642	95Ah	855
YGD100860	100Ah	1000mCA
STC8587	110Ah	750
YGD000271	110Ah	920

\*Cold cranking amps

- > Batteries are manufactured on the same equipment as OE batteries and use the same components to give consistent quality and performance
- > OE quality standards, giving assurance that the batteries will not let the user down
- > Batteries are recyclable, helping to protect the environment

**Starter Motors**



**Powerlite Starter Motors**

High torque gear reduction starter motors. These lightweight units offer increased cranking speeds and considerably more cranking power than original units, whilst drawing less current from the battery.

**NAD10040HD**

Defender - 2½ petrol 4-cylinder

**NAD101490HD**

Defender - V8/Discovery 1 - V8

Discovery 2 - V8

Range Rover P38 - V8 - 1994-2001

**RTC5225HD**

Series 3 - 2¼ petrol

**RTC5232HD**

Series 3 - 2¼ diesel

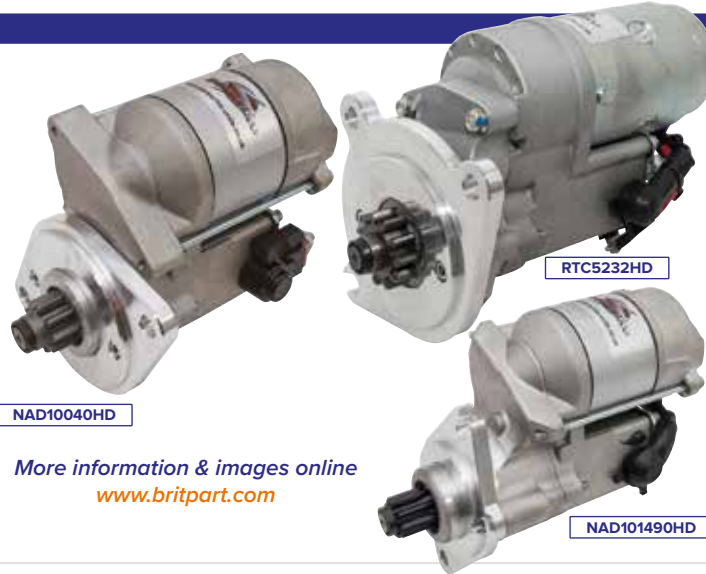

**NAD10040HD**

**RTC5232HD**

**NAD101490HD**

*More information & images online*  
[www.britpart.com](http://www.britpart.com)

**Windscreen Wiper Motors**

**DKD100620M**



**DKD100620M**

Discovery 2  
Right hand drive

**DKD100630M**

Discovery 2  
Left hand drive

**DLB101770M**

Range Rover P38  
Left hand drive



**DLB101770M**





### Air Cleaner Hose Kit



#### PHB000180HOSE

Freelander 1 - K Series Petrol  
Air cleaner assembly replacement hose with clips

### Camshaft

**511036**  
Series 1 - petrol  
Camshaft



**09023**  
Series 1  
Camshaft gear triple keyway

### Bulk Filters

**AEU2147LX**  
Fuel filters Qty 50  
Defender/Discovery 1  
Range Rover Classic - 1986 - 1994  
**ESR4686X**  
Fuel filters Qty 50  
Defender/Discovery 2  
**ERR3340X**  
Oil filters Qty 50  
Defender/Discovery 1/Discovery 2  
Range Rover Classic/Range Rover P38  
**LR170345X**  
Pollen filters Qty 50  
Discovery 3/Discovery 4  
Range Rover Sport - 2005 - 2013  
**ERR6299X**  
Rotor filters Qty 50  
Defender/Discovery 2

**x50**



**AEU2147LX**

### Con Rod Parts



**DA6626**

**DA6628**

**DA6627**

**DA6626** Con rod assembly TdV6 2.7  
**DA1527** Con rod assembly TdV6 3.0  
**DA6627** Con rod bolt TdV6 2.7 & 3.0  
**DA6628** Con rod bush TdV6 2.7 & TdV8 3.6  
**DA1598** Con rod assembly  
Range Rover L322 5.0 V8  
Range Rover Sport - Mk1 5.0 V8  
**DA1599** Con rod assembly  
Range Rover 4.4 TdV8

### Breathers



#### 247631

Rocker cover breather  
Series 1 - engine numbers 26100201 onwards  
Series 2 & Series 2A - petrol  
Series 3 - 2.25 petrol  
Engine prefix 901-904.  
From suffix E and all prefix 361 & 364

**Note** - Breather stickers supplied loose.



#### 546440

Oil filler breather  
Series 1 - engine numbers 26100201 onwards  
Series 2 & Series 2A - petrol  
Series 3 - 2.25 petrol  
Up to prefix 901 & 904, suffix D inclusive

### Cylinder Head Overhaul Kits

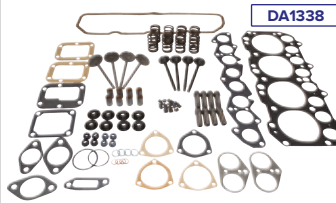

**DA1338**



**DA1340**

**DA1341**



**DA1339**



**DA1340**

**DA1341**

**DA1338** Series 2 & 2A - petrol  
Series 3 - up to 1974 - petrol  
**DA1339** Series 3 - 1974 onwards - petrol

**DA1340** Series 2 & 2A - diesel  
Series 3 - up to 1974 - diesel  
**DA1341** Series 3 - 1974 onwards - diesel

### EGR Valve & Gaskets

**LR018752V**



Replacement EGR valve and gaskets aren't available from Land Rover to repair the EGR unit. We now offer Pierburg replacements to reduce the cost of fixing the EGR system.

**LR018753V** Right hand  
**LR018752V** Left hand

Suitable for the 3.0 V6 engine  
Discovery 4  
Range Rover Sport - Mk1 - 2010 - 2013  
Range Rover Sport - Mk2 - 2014 onwards  
Range Rover L405

### Engine Oil Pan



**1359896**  
Discovery 3/Discovery 4  
Range Rover Sport - 2005 - 2009  
Engine oil pan assembly with oil drain plug and oil temperature sender assembly.

### Secondary Fuel Filter - 2 Micron



**DA2509 NEW**  
Defender - 2007 - 2016  
Equivalent to WJ15000EXP  
For use in markets which require extra fuel filtration. To be used in conjunction with the regular 5 micron and must **not** be used as a stand alone filter.



### Cylinder Heads

**Complete 300Tdi Cylinder Heads**  
Supplied with valves and head bolts, pressure tested and with heat tell tale stickers on.



**ERR5027COM**



**LDF500180COM**

**LDF500180COM**  
**Note** - This head has additional waterways for improved cooling. Use multi-leaf metal head gasket (LVB500220 - 3-hole) with this head.

### Cylinder Liner Kit

**LCJ000050LKIT**  
Liner and piston for 1.8 litre K-series engines.



### Fuel Filter Clasp Fixing Kit



**DA1670**  
Defender  
Repair kit for the fuel filter clamp casings on Defender. It's part of WKT100010 & WKT100020 and also JEU500060 & WJU500280 but not available separately from Land Rover.

### Fuel Pump Repair Kit

**AEU2760 NEW**  
Series 2, 2A & 3 - 2.25 Petrol  
Repair kit for early type fuel pump with slotted shaft



**AEU2760**

**DA5110 NEW**  
Diaphragm with T-bar notch for later fuel pumps. Diaphragm only.



**DA5110**

### Top Hose Replacement Bleed Screw

**PEH101080SCREW**

Discovery 2 - Td5  
Replacement screw for Britpart top hose  
PEH101080



Engine Bay Enhancements



**Filler Plugs**  
ERR4686BLUE  
ERR4686RED

Replace your existing filler plug with one of these smart anodised aluminium ones. Suitable for use on a Defender, Discovery 1 & Range Rover Classic on the radiator and thermostat housing. Can also be used on the diff filler level on a Discovery 2.



**DA8896**  
**Expansion Bottle Cap**  
Defender - Td5 onwards  
Freelander 1  
Smart anodised aluminium direct replacement expansion bottle cap - PCD100160. Will not fit on aluminium header tank - DA4751.



**DA8891**  
**Oil Filler Cap**  
Defender - Tdci  
Anodised aluminium. Includes rubber seal

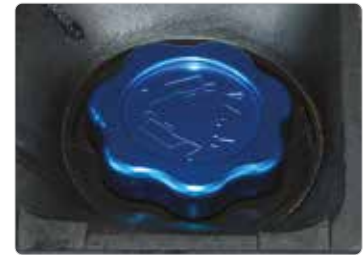

**DA8890**  
**Oil Filler Cap**  
Defender - Td5  
Anodised aluminium. Includes rubber seal



**Top Hose Bleed Screws**  
PYP10008BLUE  
PYP10008RED  
Smart replacement anodised aluminium bleed screws for the top hose on a Td5 engine.



**Coolant Overflow Container Bleed Screws**  
LR055301BLUE  
LR055301RED  
Most Land Rovers post 2010. Discovery 4/ Range Rover Sport - Mk1/Range Rover L322/ Range Rover L405  
Check screw top diameter - 21mm

**DA4748**  
**Up-rated Engine Breather Oil Catch Tank**  
200Tdi & 300Tdi engines  
Allisport high performance aluminium engine breather oil catch tank separator. Manufactured using mounting flange machined from billet aluminium. All engines need to breathe crankcase pressure to atmosphere and most are designed to re-enter the air intake system after the air cleaner.



Standard breather pots use a gauze and mesh design which over time becomes blocked with oil deposits, reducing the capacity to release crankcase pressure and also allowing more oil vapour to enter the intake system. This high performance replacement is designed to effectively reduce crankcase pressure build up on Tdi engines by using an internal baffle rather than the standard gauze and mesh design. Designed to have a practical purpose offering an improvement over the original black plastic units, but will also look great in the engine bay. Will fit all Tdi engines including 2.8 TGV. Manufactured by hand, fully TIG welded. Tank has new integral o-ring-seal design - **No More Leaks!!**



**Power Steering Reservoir Cap**  
DA8895 Standard  
DA8894 With cooling fins for extreme off-road and racing conditions  
Defender  
Anodised aluminium. Includes rubber seal.



**Aluminium Header Tanks**  
DA4750  
Defender - 200Tdi/300Tdi/V8  
Discovery 1 - 200Tdi/300Tdi/V8  
Range Rover Classic - petrol & diesel - 1990 onwards  
DA4751 Defender - Td5 & Td4 Tdci



Direct replacements for the original plastic tanks

These are direct replacements for the original plastic tanks which are prone to splitting. TIG welded by hand and manufactured from high specification lightweight non-corrosive alloy, these tanks also aid cooling. Tanks use original pressure release screw cap and are a straight fit with no modifications required. Ideal for motorsport, overland or just to improve the look of your engine bay.



**DA4749 NEW**  
**Aluminium Power Steering Reservoir with Internal Baffle**  
Defender - Tdi, Td5, Tdci & V8  
Designed to replace the plastic ZF reservoir which is prone to splitting and leaking vapour through the breathable cap, which in turn then collects dirt and runs the risk of water ingress. The external breather design means no unsightly mess under the bonnet and allows routing with high axle/gearbox breathers to eliminate water ingress. Manufactured from laser cut 2mm high grade aluminium with CNC machined pipe connections, knurled cap and external breather. The corrosion resistant aluminium rolled body is fully TIG welded by hand in house. 110mm high (155mm height including cap) & 91mm diameter.





### Gaskets & Head Bolt Sets

<b>DA2006</b>	Defender - 200Tdi	Head bolt set	
<b>STC1172B</b>	Defender - 200Tdi	Head & bolt set	No head gasket
<b>DA2005</b>	Defender - 300Tdi	Head bolt set	
<b>STC2802B</b>	Defender - 300Tdi	Head & bolt set	No head gasket
<b>DA2112</b>	Defender - Td5	Head set	No head gasket
<b>DA2112B</b>	Defender - Td5	Head & bolt set	No head gasket
<b>DA2112-1</b>	Defender - Td5	Head set	1-hole gasket
<b>DA2112-2</b>	Defender - Td5	Head set	2-hole gasket
<b>DA2112-3</b>	Defender - Td5	Head set	3-hole gasket
<b>DA3355 NEW</b>	Defender - Td5	Head bolt set	
<b>DA2112G-EARLY</b>	Defender - up to 1A622423 - Td5	Elring head set	No head gasket
<b>DA2112G-LATER</b>	Defender - 1A622424 onwards - Td5	Elring head set	No head gasket
<b>DA2113</b>	Defender - Td5	Bottom set	
<b>DA2508</b>	Defender - Puma 2.4	Head set	No head gasket
<b>DA2508G</b>	Defender - Puma 2.4	OEM head set	No head gasket
<b>DA2505</b>	Defender - Puma 2.4	Head bolt set	
<b>DA5156 NEW</b>	Defender - Puma 2.4	Cam cover gasket set	
<b>DA2518</b>	Defender - Puma 2.2	Head set	No head gasket
<b>DA2506</b>	Defender - Puma 2.2	Head bolt set	
<b>DA2006</b>	Discovery 1 - 200Tdi	Head bolt set	
<b>STC1172B</b>	Discovery 1 - 200Tdi	Head & bolt set	No head gasket
<b>DA2005</b>	Discovery 1 - 300Tdi	Head bolt set	
<b>STC2802B</b>	Discovery 1 - 300Tdi	Head & bolt set	No head gasket
<b>DA2112</b>	Discovery 2 - Td5	Head set	No head gasket
<b>DA2112B</b>	Discovery 2 - Td5	Head & bolt set	No head gasket
<b>DA2112-1</b>	Discovery 2 - Td5	Head set	1-hole gasket
<b>DA2112-2</b>	Discovery 2 - Td5	Head set	2-hole gasket
<b>DA2112-3</b>	Discovery 2 - Td5	Head set	3-hole gasket
<b>DA3355 NEW</b>	Discovery 2 - Td5	Head bolt set	
<b>DA2112G-EARLY</b>	Discovery 2 - up to 1A736339 - Td5	Elring head set	No head gasket
<b>DA2112G-LATER</b>	Discovery 2 - 2A736340 onwards - Td5	Elring head set	No head gasket
<b>DA2113</b>	Discovery 2 - Td5	Bottom set	
<b>DA2141</b>	Discovery 2 - 4.0/4.6 V8 ten bolt heads	Head bolt set	
<b>DA5132</b>	Discovery 3 - 2.7 TdV6	Head set	No head gasket
<b>DA5129</b>	Discovery 3 - 2.7 TdV6	Bottom set	
<b>DA3367</b>	Discovery 3 - 2.7 TdV6	Head bolt set	
<b>DA1900</b>	Discovery 4 - 3.0 TdV6	Head set	No head gasket
<b>DA1900</b>	Discovery 5 - 3.0 TdV6	Head set	No head gasket
<b>DA5128</b>	Discovery Sport - 2.2 diesel	Cam cover gasket set	
<b>DA3369</b>	Discovery Sport - 2.2 diesel	Head bolt set	
<b>DA2114</b>	Freelander 1 - 1.8 16v	Head set	Inc. head gasket
<b>DA2114B</b>	Freelander 1 - 1.8 16v	Head set	Inc. head gasket & head bolt sets
<b>DA2115</b>	Freelander 1 - 1.8 16v	Bottom set	
<b>DA3143</b>	Freelander 1 - 2.5KV6	Head set	Inc. head gasket
<b>DA3145</b>	Freelander 1 - 2.0 diesel L series	Head set	No head gasket
<b>DA3357</b>	Freelander 1 - 2.0 diesel L series	Head bolt set	
<b>DA3356</b>	Freelander 1 - 1.8 16v	Head bolt set	
<b>DA5128</b>	Freelander 2 - 2.2 diesel	Cam cover gasket set	
<b>DA3369</b>	Freelander 2 - 2.2 diesel	Head bolt set	
<b>DA2006</b>	Range Rover Classic - 200Tdi	Head bolt set	
<b>STC1172B</b>	Range Rover Classic - 200Tdi	Head & bolt set	No head gasket
<b>DA2005</b>	Range Rover Classic - 300Tdi	Head bolt set	
<b>STC2802B</b>	Range Rover Classic - 300Tdi	Head & bolt set	No head gasket
<b>DA2141</b>	Range Rover P38 - 4.0/4.6 V8 ten bolt heads	Head bolt set	
<b>DA3368</b>	Range Rover Sport - Mk1 - TdV8	Head bolt set	
<b>DA5132</b>	Range Rover Sport - Mk1 - 2.7 TdV6	Head set	No head gasket
<b>DA5129</b>	Range Rover Sport - Mk1 - 2.7 TdV6	Bottom set	
<b>DA3367</b>	Range Rover Sport - Mk1 - 2.7 TdV6	Head bolt set	
<b>DA5181 NEW</b>	Range Rover Sport - Mk1 - 3.6 TdV8	Head set	No head gasket
<b>DA1900</b>	Range Rover Sport - Mk2 - 3.0 TdV6	Head set	No head gasket
<b>DA5180 NEW</b>	Range Rover Sport - Mk2 - 4.4 TdV8	Head set	Inc. head gasket
<b>DA3368</b>	Range Rover L322 - TdV8	Head bolt set	
<b>DA5181 NEW</b>	Range Rover L322 - 3.6 TdV8	Head set	No head gasket
<b>DA5180 NEW</b>	Range Rover L322 - 4.4 TdV8	Head set	Inc. head gasket
<b>DA5128</b>	Range Rover Evoque - 2.2 diesel	Cam cover gasket set	
<b>DA3369</b>	Range Rover Evoque - 2.2 diesel	Head bolt set	
<b>DA1900</b>	Range Rover L405 - 3.0 TdV6	Head set	No head gasket
<b>DA5180 NEW</b>	Range Rover L405 - 4.4 TdV8	Head set	Inc. head gasket
<b>DA1900</b>	Range Rover Velar - 3.0 TdV6	Head set	No head gasket

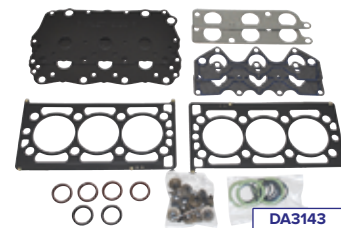
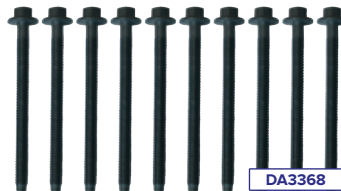
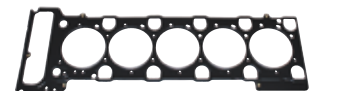
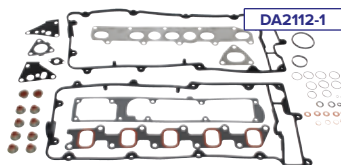
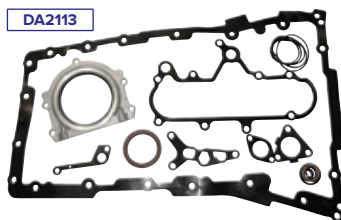

Photo by Richard Rushton

### Inlet Manifold Fitting Kit



**DA7014**  
Contains all seals and gaskets required to fit a right hand or left hand inlet manifold.  
Discovery 4 - TdV6 3.0  
Range Rover Sport - TdV6 3.0  
1 x EGR gasket - LR038333  
3 x Lower injector seal - LR032818  
3 x Injector o-ring - LR022992  
3 x Top injector seal - LR054612

### Manifold Assembly Fuel Sensor



**LR022983SENSOR NEW**  
Range Rover L322  
- 2010 - 2012  
Range Rover L405  
Range Rover Sport  
- 2014 onwards



### Manifold Links



**1357035**  
Manifold link pipe including heat resistant sleeve for 2.7 V6 diesel engines  
Discovery 3/Discovery 4  
Range Rover Sport - 2005 - 2009



**LR038751 NEW**  
Manifold link pipe including heat resistant sleeve for 3.0 V6 diesel engines.  
Discovery 4/ Discovery 5  
Range Rover Sport - 2010 - 2013  
Range Rover Sport - 2013 onwards  
Range Rover L405

### Manifold Inlet Seal



**LR0044045**  
Defender - Puma  
Manifold inlet seal. This is not available as a separate part from Land Rover.

### Engines



DA1183

<b>DA4250DIS</b>	Discovery 1 - 200Tdi	Reconditioned	Complete
<b>STC4723N</b>	300Tdi	Reconditioned	Stripped
<b>DA2039</b>	Freelander 1 - 1.8K	New	Complete
<b>DA1510</b>	Td5 - late 15P	Reconditioned	Stripped
<b>DA1182</b>	Defender - 2.4Tdi	New	Stripped
<b>DA1183</b>	Defender - 2.2Tdi	New	Stripped

**Note** - New engines have a 2 year warranty. Reconditioned engines have a 1 year warranty.

Please contact your nearest Britpart stockist for more details  
[www.britpart.com/stockist](http://www.britpart.com/stockist)

Fuel Filter Holder



**DA1159**  
Defender - 2007 onwards  
Replacement fuel filter holder

Heater Plug Upgrade Kit

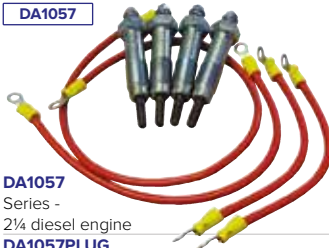

**DA1057**  
Series -  
2 1/4 diesel engine  
**DA1057PLUG**  
Replacement heater plug set for DA1057

Injector Pipe Sets

Set of 4 injector pipes per kit  
**563165/6/7/8**  
Series - 2.25 diesel  
Defender - 2.25 diesel  
**ETC4291/2/3/4**  
Defender 2.5 diesel & 2.5 diesel turbo  
**STC793/4/5/6**  
Defender - 200Tdi  
**RTC6732/3/4/5**  
Discovery 1  
Range Rover Classic - 200Tdi  
**STC1694/5/6/7**  
Defender - 300Tdi - Less EDC  
Discovery 1 - 300Tdi - Less EDC  
Range Rover Classic - 300Tdi - Less EDC

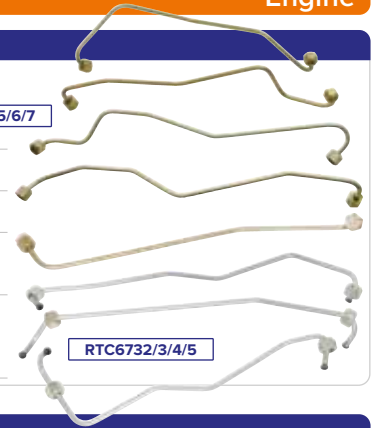

**STC1964/5/6/7**

**RTC6732/3/4/5**

Injector Washer Kits

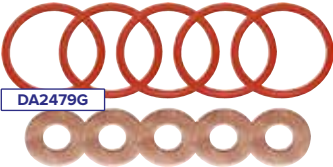

**DA2479G**  
Td5 injector washer kits - O-rings & washers  
**DA2479LR** Genuine set  
**DA2479G** OEM set  
**DA2479** Britpart set

Avdel Plug



**DA1906**  
Avdel plug for Td5 oil gallery

Inlet Manifold



**LR179201** Right hand  
**LR166213** Left hand  
Discovery 5 - 3.0 V6  
Range Rover Velar - 3.0 V6  
Range Rover Sport - Mk2 - 3.0 V6  
Range Rover L405 - 3.0 V6

Piston Ring Sets

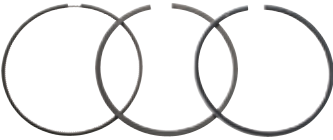

**DA5152RINGS** **DA5134**  
Defender 2.2 engine  
**DA5126**  
TdV6 - 2.7 engine  
**DA1635RINGS**  
Standard  
TdV6 - 3.0 engine EU6  
**DA3426 NEW**  
Standard  
Ingenium 204DTD engine  
**DA1938**  
Standard  
TdV8 - 4.4 engine  
**DA5134**  
Freelander 2 - 2.2  
Range Rover Evoque - 2.2  
**DA1597**  
Individual - standard  
Range Rover Sport - Mk1 - 5.0 V8  
Range Rover L322 - 5.0 V8

Pistons With Ring Sets



**DA5152**  
**DA5127**  
Individual - standard  
TdV6 - 2.7 engine  
**DA5127020**  
Individual - 0.020"/0.50mm  
TdV6 - 2.7 engine  
**DA1635**  
Individual - standard  
TdV6 - 3.0 engine EU6  
**DA1937**  
Individual - standard  
TdV8 - 4.4 engine  
**DA5152**  
Individual - standard  
Defender 2.2 engine  
**DA3424 NEW**  
Individual - standard  
Ingenium 204DTD engine  
**DA1596**  
Individual - standard  
5.0 V8 - naturally aspirated  
Range Rover Sport - Mk1  
Range Rover L322  
**DA1719**  
Individual - standard  
5.0 V8 - supercharged  
Range Rover Sport - Mk1  
Range Rover L322

Main Bearing & Con Rod Bearing Sets

Main Bearing Sets		Con Rod Bearing Sets	
<b>DA5121</b> Standard	Defender - 2.4 & 2.2	<b>DA6620</b> Standard	2.7 TdV6 & 3.0 TdV6
<b>DA5121025 NEW</b> 0.010"/0.25mm	Defender - 2.4 & 2.2	<b>DA6621</b> 0.010"/0.25mm	2.7 TdV6 & 3.0 TdV6
<b>DA5121AE</b> Standard	Defender - 2.4 & 2.2 Glyco brand set	<b>DA6622</b> 0.020"/0.50mm	2.7 TdV6 & 3.0 TdV6
<b>DA5121025AE</b> 0.010"/0.25mm	Defender - 2.4 & 2.2 Glyco brand set	<b>DA1934</b> 0.030"/0.76mm	2.7 TdV6 & 3.0 TdV6
<b>DA5121050AE</b> 0.020"/0.50mm	Defender - 2.4 & 2.2 Glyco brand set	<b>DA6656</b> Standard	3.6 TdV8 & 4.4 TdV8
<b>DA3452 NEW</b> Standard	AJ200/204 - 150/180hp	<b>DA6657</b> 0.010"/0.25mm	3.6 TdV8 & 4.4 TdV8
<b>DA3454 NEW</b> 0.010"/0.25mm	AJ200/204 - 150/180hp	<b>DA6658</b> 0.020"/0.50mm	3.6 TdV8 & 4.4 TdV8
<b>DA3456 NEW</b> 0.020"/0.50mm	AJ200/204 - 150/180hp	<b>DA6659</b> 0.030"/0.76mm	3.6 TdV8 & 4.4 TdV8
<b>DA3469 NEW</b> Standard	AJ200/204 - 200/240hp	<b>DA3451 NEW</b> Standard	AJ200/204 - 150/180hp
<b>DA3470 NEW</b> 0.010"/0.25mm	AJ200/204 - 200/240hp	<b>DA3453 NEW</b> 0.010"/0.25mm	AJ200/204 - 150/180hp
<b>DA3471 NEW</b> 0.020"/0.50mm	AJ200/204 - 200/240hp	<b>DA3455 NEW</b> 0.020"/0.50mm	AJ200/204 - 150/180hp
<b>DA5120</b> Standard	Freelander 1 - K-Series 1.8	<b>DA3466 NEW</b> Standard	AJ200/204 - 200/240hp
<b>DA6623</b> Standard	2.7 TdV6 & 3.0 TdV6	<b>DA3467 NEW</b> 0.010"/0.25mm	AJ200/204 - 200/240hp
<b>DA6624</b> 0.010"/0.25mm	2.7 TdV6 & 3.0 TdV6	<b>DA3468 NEW</b> 0.020"/0.50mm	AJ200/204 - 200/240hp
<b>DA6625</b> 0.020"/0.50mm	2.7 TdV6 & 3.0 TdV6		
<b>DA1933</b> 0.030"/0.76mm	2.7 TdV6 & 3.0 TdV6		

Con Rod & Main Bearing Sets	
<b>DA1580</b> Standard	2.7 TdV6 & 3.0 TdV6
<b>DA1581</b> 0.010"/0.25mm	2.7 TdV6 & 3.0 TdV6
<b>DA1582</b> 0.020"/0.50mm	2.7 TdV6 & 3.0 TdV6

Big End Bearing Sets	
<b>DA2878</b> Standard	5.0L & 5.0T
<b>DA2879</b> 0.010"/0.25mm	5.0L & 5.0T
<b>DA2880</b> 0.020"/0.50mm	5.0L & 5.0T
<b>DA2881</b> 0.030"/0.76mm	5.0L & 5.0T



**DA6621**



**DA6660**



Hastings Piston Ring Sets

**8510072H**  
Series 2, 2A, 3 - 2.25 petrol  
Defender - 2.25 petrol  
**LFP101320LH**  
Freelander 1 - 1.8 K Series  
**LFT000100H**  
Range Rover L322 - 2002 - 2009  
4.4 V8 M62 BMW  
**LFT100390LH**  
Freelander 1 - 2.0 diesel TD4 BMW  
Range Rover L322 - 3.0 diesel TD6 BMW  
**RTC2408H**  
Defender - 3.5 V8  
Discovery 1 - 3.5 V8  
Range Rover Classic - 3.5 V8  
**RTC6066SH**  
Defender - 3.9 V8  
Discovery 1 - 3.9 V8  
Range Rover Classic - 3.9 V8  
**STC958H**  
Defender - 300Tdi  
Discovery 1 - 300Tdi  
Range Rover Classic - 300Tdi  
**STC1427H**  
Defender - 4.0 V8  
Discovery 1 - 3.9/4.0 V8  
Discovery 2 - V8  
Range Rover P38 - V8

Connector Assembly Fuel Blocks



**LR016318GR**



**NEW**  
**LR016318GR**  
**LR016319GR**  
Defender - Td5  
Less hoses,  
includes gasket.  
**LR016319GR**



### Potentiometer Kit



DA1647

#### Rover V8 Throttle Pot Upgrade Kit

Adapts the Rover plenum to accept the Colvern throttle pot. Replaces the 2 bolt throttle pot as fitted to all 3.9 & later 3.5 engines from late flapper to last of the Hotwire 14CUX. It replaces ETC8495 and ERR2263. Consists of: Colvern throttle pot, alloy adapter plate, brass spindle, ball bearing, stainless cover plate, fixings & loom socket. Once this kit is fitted, throttle pot switch replacements are cheaper and easy to source.

**DA1647SET NEW**

Replacement plug & pin set

### Rockers - Aluminium



602153A

602153A

602154A

Defender - 1987 - 2006  
Discovery 1  
Discovery 2  
Range Rover Classic - 1986 - 1994  
Range Rover P38 - 1994 - 2001

602154A

### Pressure Relief Valve



DA2376

300Tdi oil pump relief valve kit for Defender/Discovery 1  
Range Rover Classic

### Td5 Short Oil Filter

Save time & effort with this easier to fit filter



LPX100590XD

Td5 oil filter. Shorter than the standard filter which makes this one much easier to fit and remove.

### Oil Pump Gear Set



DA4189

Discovery 1/Discovery 2/Range Rover P38  
Oil pump gear set for V8 engines

### Oil Cooler Repair Kit



DA1127

Td5 oil cooler repair kit, to replace leaking oil cooler found in all Td5 engines, part of the PBC500230 assembly. Replace just the faulty cooler and not the casting which normally is perfectly serviceable, includes all hardware required. All manufactured to exact OEM specification.

### Radiator Hose Kit



DA1336

Series 2, 2A & 3  
Radiator hose kit

### Td5 Oil Pump

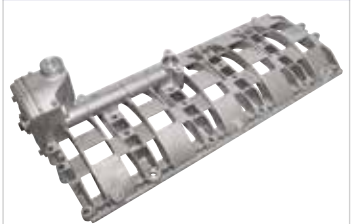

LPF500020

High quality, cost effective replacement oil pump for Td5 engines.

### TdV6 Engine Parts

#### Con Rod & Main Bearing Sets

DA1580	Standard	2.7 & 3.0 engines
DA1581	0.010"/0.25mm	2.7 & 3.0 engines
DA1582	0.020"/0.50mm	2.7 & 3.0 engines

#### Con Rod Bearing Sets

DA6620	Standard	2.7 & 3.0 engines
DA6621	0.010"/0.25mm	2.7 & 3.0 engines
DA6622	0.020"/0.50mm	2.7 & 3.0 engines

#### Main Bearing Sets

DA6623	Standard	2.7 & 3.0 engines
DA6624	0.010"/0.25mm	2.7 & 3.0 engines
DA6625	0.020"/0.50mm	2.7 & 3.0 engines

#### Gaskets

DA5132	Head set - no head gasket	2.7 engines
DA1900	Head set - no head gasket	3.0 engines
DA5129	Bottom set	2.7 engines

#### Con Rod Parts

DA6626	Con rod assembly	2.7 engines
DA1527	Con rod assembly	3.0 engines
DA6627	Con rod bolt	2.7 & 3.0 engines
DA6628	Con rod bush	2.7 & 3.0 engines

#### Pistons & Piston Ring Sets

DA5127	Individual - standard piston fitted with ring set	2.7 engines
DA5127020	Individual - 0.020"/0.50mm piston fitted with ring set	2.7 engines
DA1635	Individual - standard piston fitted with ring set	3.0 engines EU6
DA5126	Piston ring set	2.7 engines
DA1635RINGS	Piston ring set - standard	3.0 engines EU6

### Exhaust Clamps



DA4062	45mm	Qty 1
DA4186	54mm	Qty 1
DA4063	60mm	Qty 1
DA4064	65mm	Qty 1

### Bleed Screw



JHC500150SCREW NEW

Bleed screw  
Radiator - heater outlet  
Defender 2007 - 2016

### Carburettor Float



605833G

NEW

Carburettor float  
V8 - Stromberg CD175  
Series 3 - 2.6/Series 3 - 3.5 V8  
Defender - 1987 - 2006 - 3.5 V8  
Range Rover Classic - 1986 - 1991 - 3.5 V8

### TdV6 Injector Seal Kit



DA3404 NEW

Injector Seal Kit  
Discovery 3 - 2.7 TdV6  
Range Rover Sport - 2.7 TdV6

### Exhaust Fitting Kits



All you need to replace the exhaust on a Series - SWB.

DA1293 Right hand drive  
DA1294 Left hand drive



### Td5 Fuel Filter Non-Return Valve Repair Kit



DA3950

Defender - Td5/Discovery 2 - Td5  
A common Td5 fault which causes poor starting and running can be caused by a faulty non-return valve in the fuel filter head. This kit fixes that problem without having to replace the whole fuel filter head. Included in the kit is a non-return valve, rubber duckbill valve and sealing washer.

### Water Sensor Repair Kit



LR045519REPAIRKIT

Discovery 4 Header only  
Range Rover Sport - 2010 - 2013

### Water Housing Kit



DA4697

Td5 engines  
Replacement water housing including seal

### Top Hat Liner Set



DA1185

This flanged repair liner is suitable for damaged/porous 3.9/4.0/4.2/4.6 Rover V8 blocks. The block will require re-boring and flange recess machining before fitting. This liner is the complete solution for fixing these blocks. The liner can be bored to 96.00mm for over-bored versions of the V8 engine, taking it to 5.0 litres. Semi finished bore 94.00mm (less 1.00mm for final finishing in bore).

#### Dimensions

Inside diameter - 94.00mm  
Outside diameter - 99.06mm  
Length - 135.64mm  
Flange diameter - 105.23mm  
Flange depth - 5.33mm



Join our regular newsletter  
[www.britpart.com/newsletter](http://www.britpart.com/newsletter)

Timing Belt & Chain Kits

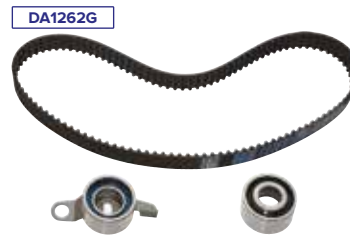
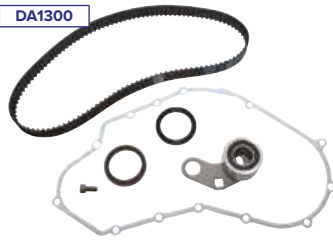
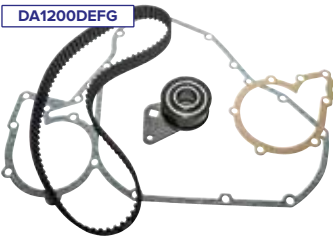

Timing Belt Kits

<b>DA1200DEF</b>	Defender - 200Tdi	
<b>DA1200DEFG</b>	Defender - 200Tdi	OEM tensioner
<b>DA1264G</b>	Defender - 2.5D & 2.5TD	OEM kit
<b>DA1200DIS</b>	Discovery 1/Range Rover Classic - 200Tdi	
<b>DA1200DISG</b>	Discovery 1/Range Rover Classic - 200Tdi	OEM tensioner
<b>DA1300</b>	Defender/Discovery 1/Range Rover Classic - 300Tdi engines	
<b>DA1300G</b>	Defender/Discovery 1/Range Rover Classic - 300Tdi engines	OEM kit
<b>DA1261G</b>	Freelander 1 - 1.8 Manual tension	OEM kit
<b>DA1265G</b>	Freelander 1 - 1.8 Automatic tension	OEM kit
<b>DA1262G</b>	Freelander 1 - 2.0Tcie 114 teeth	OEM kit
<b>DA1263G</b>	Freelander 1 - 2.0Tcie 112 teeth	OEM kit

Timing Chain Kits

<b>DA1337</b>	Series 2 - 2.25 petrol
	Series 2A - 2.25 petrol
	Series 3 - up to 1974 - 2.25 petrol
<b>DA2663</b>	Defender - 2007 onwards - 2.4 and 2.2



Many more kit photos available online at [www.britpart.com](http://www.britpart.com)

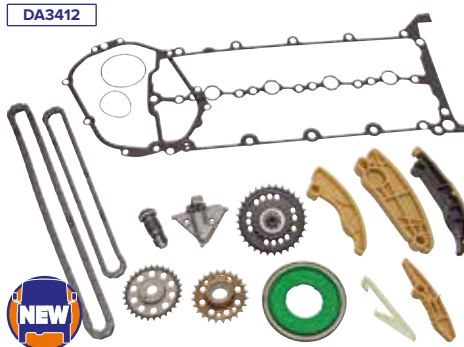

**DA3411 NEW**

FAI kit for Ingenium AJ200D engines

Kit contains -

<b>Guides</b>	LR073755 / LR073756 / LR073761 / LR124262 / LR120540
<b>Chains</b>	LR132676 / LR139320
<b>Tensioners</b>	LR084294 / LR138833



**DA3412 NEW**

FAI kit with sprockets and gaskets for Ingenium AJ200D engines -

Kit contains -

<b>Guides</b>	LR073755 / LR073756 / LR073761 / LR124262 / LR120540
<b>Chains</b>	LR132676 / LR139320
<b>Tensioners</b>	LR084294 / LR138833
<b>Sprockets</b>	LR073765 / LR124261 / LR073744 & Gaskets

**DA3416 NEW**

FAI kit for 5.0L AJ133 & 3.0L AJ126 engines

Kit contains -

<b>Guides</b>	LR051011 / LR051012
<b>Chains</b>	LR032048 / LR032087
<b>Tensioners</b>	LR095472 / LR051013 / LR087162
<b>Sprockets</b>	LR072638 / LR072611 / LR011218

XS Water Pumps

**4575902G** Discovery 3 - 4.4V8  
Range Rover Sport - 2005 - 2009 - 4.2 & 4.4 V8  
Range Rover L322 - 2005 - 2009 - 4.2 & 4.4 V8

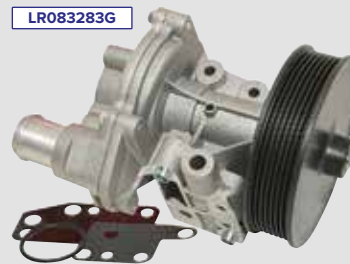
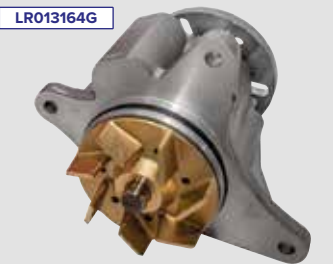

**LR013164G** Discovery 4  
Range Rover Sport - 2010 - 2013 & 2014 onwards  
Range Rover L405

**LR022688G NEW** Range Rover Sport - 2014 onwards  
Range Rover - L322 - 2010 - 2012  
Range Rover - L405

**LR083283G** Defender - 2007 onwards  
**LR097165G** Defender 2020  
Discovery 4  
Discovery 5  
Range Rover Velar  
Range Rover Sport - Mk2  
Range Rover L405

**PEB102240LG** Freelander 1  
**PEB102420LG** Discovery 1  
Freelander 1

**PEB102510LG** Freelander 1 - 1.8K petrol  
**PEB500090G** Defender - 1987 - 2006

Discovery 1  
Range Rover Classic - 1992 - 1994

**PEM500040G** Defender - Td5  
Discovery 2 - Td5

**STC3758G** Series 2A  
Series 3 - 2.25l - 9-stud

**STC4378G** Defender - 1987 - 2006 - 4.0 V8  
Discovery 1 - 4.0 V8  
Discovery 2 - 4.0 V8  
Range Rover P38 - 4.0 V8

**STC483G** Defender - 1987 - 2006  
Discovery 1  
Range Rover Classic - 1992 - 1994

**STC637G** Defender - 1987 - 2006  
**STC639G** Defender - 200Tdi



**LR097165G**





# REPAIR & SERVICE

## Heating

### Heater Blower Motor Kit & Resistor Kit



DA4178

DA4178RESISTOR

**DA4178**  
Range Rover Classic - 1990 - 1994 - 200Tdi with air con  
Discovery 1 - 200Tdi with air con  
Atlantic British has developed this all inclusive kit designed and engineered to replace failed heater motors. The kit includes heater blower motor, blower wheel, motor mounting bracket and mounting screws, heater assembly seals, nylon ties, solder, shrink tubing (for soldered connections) and complete instructions. **Note** - When replacing the heater blower motor the vehicle's resistor must be upgraded to DA4178RESISTOR.

**DA4178RESISTOR**  
The air con blower motor resistor controls the speed of the blower motor and the force of the airflow out of the dash vents, it features a thermal-sink aluminium mounting plate that dissipates circuit heat effectively.

### Air-con Evaporator Core



**DA2660**  
Defender - 2007 onwards  
If your Defender's air-con evaporator is broken, you cannot purchase a replacement evaporator core alone. Instead you have to purchase the whole heater unit. We can now offer this OEM replacement evaporator core offering a considerable cost saving over the complete assembly.

### Valve Unit



**JQD500080V**  
Defender - 2007 onwards  
Valve unit from JQD500080  
No bracket



Keep up to date with all the latest accessories - sign up to our newsletter today.  
[www.britpart.com/newsletter](http://www.britpart.com/newsletter)

### Heater Matrixes

- DA2155** UTP1725  
Series 3
- AAP817**  
Defender - downward facing pipes
- UTP1725**  
Defender - horizontal inlet/outlet pipes
- JEF100220**  
Defender - LHD - XA159807 onwards
- STC250**  
Discovery 1
- STC3135**  
Range Rover Classic - 1986 - 1994
- STC3135**  
Discovery 1
- JEF100150**  
Range Rover Classic - 1992 - 1994
- JEF100150**  
Freelander 1 - up to YA999999
- STC3261**  
Range Rover P38



More images online at [www.britpart.com](http://www.britpart.com)

DA4744

DA4743

*Twice the capacity of standard*

**Uprated High Output Heater Matrixes**  
AlliSport uprated high output heater matrixes with high quality vacuum brazed cores and louvred fins. These larger matrixes have twice the capacity of standard which increases heat output and improves windscreen demisting times. TIG welded by hand. Only requires some small mods to the heater box to install.

**DA4743**  
Defender - early models with downward facing pipes. Equivalent to AAP817.

**DA4744**  
Defender - late models with horizontal inlet/outlet pipes. Right hand drive (including some LHD NAS spec). Check your application before ordering. Not suitable for Puma 2.4 and 2.2 vehicles. Equivalent to UTP1725.



Photo by Roger Miles



Clutches

Heavy-duty Clutches & Parts

<b>DA5551</b>	Defender/Discovery 1/Range Rover Classic - 200/300Tdi	Heavy-duty clutch kit - plate, cover & bearing
<b>DA5551G</b>	Defender/Discovery 1/Range Rover Classic - 200/300Tdi	OEM heavy-duty clutch kit - plate, cover & bearing
<b>DA5551KIT</b>	Defender/Discovery 1/Range Rover Classic - 200/300Tdi	Heavy-duty clutch kit - plate, cover, heavy-duty bearing & heavy-duty clutch fork
<b>DA5552</b>	Defender/Discovery 1/Range Rover Classic - 200/300Tdi	Heavy-duty clutch kit - plate, cover, less bearing
<b>DA2357HD</b> - Britpart	Defender/Discovery 2 - Td5	Heavy-duty clutch kit - plate, cover, heavy-duty flywheel & bearing
<b>DA2357HDG</b> - AP Driveline	Defender/Discovery 2 - Td5	Heavy-duty clutch kit - plate, cover, heavy-duty flywheel & bearing
<b>DA2357CP</b>	Replacement clutch kit for DA2357HD	Heavy-duty clutch kit - plate & cover
<b>PSD103470BRG</b>	Replacement clutch release bearing for DA2357HD	Clutch release bearing - heavy-duty
<b>LR072972</b>	Defender - 2007 onwards	Up-rated clutch kit - plate & cover
<b>FTC2957HD</b>	Defender/Discovery 1/Range Rover Classic - various	Clutch fork - heavy-duty
<b>FTC2957HDKIT</b>	Defender/Discovery 1/Range Rover Classic - diesel only/non-V8 Various applications	Clutch fork installation kit - heavy-duty Includes heavy-duty clutch fork, slipper pads, bush, staple & clip
<b>FTC5200HD</b>	Defender - 1987 - 2006/Discovery 1/Discovery 2/Range Rover P38	Clutch release bearing - heavy-duty

Standard Clutches & Parts

<b>DA5550</b>	Defender/Discovery 2 - Td5 Clutch kit - plate, cover & bearing
<b>DA5550G</b>	Defender/Discovery 2 - Td5 Clutch kit OEM - plate & cover less bearing
<b>DA2357</b>	Defender/Discovery 2 - Td5 Clutch kit - plate, cover, flywheel & bearing
<b>DA2357G</b>	Defender/Discovery 2 - Td5 Clutch kit - Valeo - plate, cover & flywheel
<b>LR009366 NEW</b>	Defender - diesel (non-Td5)/Discovery 1 - diesel Range Rover Classic Clutch kit - plate, cover & bearing
<b>LR117128</b>	Defender - 2007 onwards Clutch kit - plate & cover
<b>LR117128C</b>	Defender - 2007 onwards Clutch cover
<b>LR117128P</b>	Defender - 2007 onwards Clutch plate
<b>STC8363</b>	Series 3 Clutch kit - plate, cover & bearing
<b>DA2369</b>	Series 2 & 2A Clutch kit (9") - plate & cover
<b>DA2370</b>	Series 2A Clutch kit (9 1/2") - plate & cover
<b>EST110075/76ES</b>	Santana - 2.8 Anibal PS10 Clutch kit - Borg & Beck - plate, cover & bearing
<b>URB500060</b>	Freelander 1 - 2.0 Tc1e Clutch kit - plate, cover & bearing
<b>URB500060G</b>	Freelander 1 - 2.0 Tc1e Clutch kit - plate, cover & bearing

DA5558

<b>DA5558</b>	Freelander 2 - 2.2 diesel Clutch kit - plate, cover & concentric slave cylinder
<b>LR008556</b>	Freelander 2 - up to AH999999 Clutch kit OEM - plate & cover
<b>DA5559</b>	Freelander 2 - BH000001 onwards/Range Rover Evoque Clutch kit OEM - plate, cover & concentric slave cylinder

## Changing your clutch?

Then demand your stockist uses a clutch kit from Britpart!

- > Extensive testing ensures the ultimate specification
- > Premier friction material gives longer life
- > Self centring bearing provides smooth operation
- > Intense quality control ensures fit first time

For many more clutch images available at [www.britpart.com/clutches](http://www.britpart.com/clutches)



Dual Mass Flywheel Conversion Kits

The flywheel conversion kit can be used to replace the dual mass flywheel using a solid metal flywheel and a heavy duty clutch kit. The one piece flywheel will not break up like the dual mass one so it is highly likely you will never need to change it again which means - lower cost, ease of fitting & potentially eliminating any future flywheel failures.

**Note** - This kit will make the gearbox more audible in the car at tick over and the kit doesn't include the release bearing - UUB000070.

DA6250

<b>DA6250</b>	Freelander 1 - 2.0 Td4 Dual mass flywheel conversion kit - solid mass flywheel, replacement clutch cover & replacement clutch plate
<b>DA6250G</b>	Freelander 1 - 2.0 Td4 OEM dual mass flywheel conversion kit - solid mass flywheel, replacement clutch cover & replacement clutch plate

DA6251

Service kit for DA6250  
Plate & cover

DA6250





### Auto Transmission Lever Parts

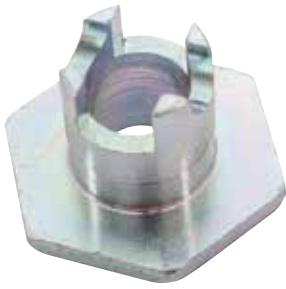

Discovery 2  
**FTC4746BUSH** FTC4746 - bush only

### Clutch & Brake Reservoir Tank



**504105G**  
Series 2/Series 2A Replacement combined brake and clutch reservoir serves both the brake and clutch master cylinders. An internal wall avoids a failure of both systems if one develops a leak. Reservoir is as per original design.

### Clutch Pedal Assist Kit



**DA1266**  
Replace the old clutch pedal spring kit to assist the pressing of the clutch pedal on Defender models. This is a factory fit on later models but can be retro fitted to all 90/110 models. Consists of spring, spring retainer & spring bushes

### Crown Wheel & Pinion



**TAG000230CWP**  
Freelander 1 Replacement crown wheel & pinion for IRD TAG000230.

### Clutch Cylinders

**STC500100GIRLING**

OEM clutch cylinders from Girling



**266694G**

**266694G**  
Clutch slave cylinder Series 2/Series 2A

**STC500100GIRLING**  
Series 3  
Clutch master cylinder 90/110

### Gearboxes

#### Gearboxes - Reconditioned

<b>DA3050</b>	Defender - 4-cylinder up to 200Tdi	LT77/S	50G/H
<b>DA3051</b>	Defender - 200Tdi	LT77/S	56G/H
<b>TRC103160E</b>	Defender - 300Tdi	R380	56J
<b>TRC103260E</b>	Defender - Td5	R380	68A - suffix L
<b>LR039149</b>	Defender - 2007 onwards		6-speed
<b>DA3054</b>	Discovery 1 - 300Tdi	R380	55J
<b>TRC103350E</b>	Discovery 2 - diesel - less oil cooler		
<b>DA3055</b>	Range Rover P38 - diesel	R380	65J

#### Gearboxes - New

**TRC102900LR**  
Freelander 1 - Petrol 1.8 K16  
**DA1883**  
2.0l Ingenium engine  
4-wheel drive gearbox



### Double Cardan Repair Kits

**DA1277**



**DA1277** Britpart kit  
**DA1277G** OEM kit  
Discovery 2 rear diff rebuild kit  
Double cardan joint repair kit for Discovery 2 propshafts - TVB000100 & TVB000220.

### Damper & Bearing Kit



**DA2664** Damper & bearings kit  
**TOT100000 NEW** Damper only  
Freelander 1 - up to 2006 4-cylinder  
Not all viscous coupling problems are the fault of the unit itself, sometimes the damper is at fault, this kit prevents buying the whole coupling, just to replace the damper.

### Detent Repair Springclip



**DA6247**  
Detent repair springclip to fit Discovery 3 & Discovery 4 manual gearboxes.  
To save expensive gearbox repairs or replacements it may just be this simple clip has broken. It is easily checked and replaced without any removal of the gearbox itself.

*Experiencing problems engaging reverse gear?*

### Girling Classic Clutch Hoses



Made in the UK

### Diff Coupling Shaft



**DA2355**  
Range Rover L322 - 2002 onwards, suffer from a common problem with the coupling shaft spline wearing between the front propshaft and front differential, thus losing drive to the differential.

**We are now able to offer a cheaper alternative!**

The problem relates to the coupling shaft, the differential itself is not affected. Currently the only solution offered by Land Rover is to replace the propshaft and the whole complete front differential assembly - a very expensive option! Using this new coupling shaft will enable you to replace just the propshaft and coupling shaft and leave the differential in place, therefore reducing both time (the differential need not be removed from the vehicle) and cost.

### Diff Repair Pans



**DA1043**

**DA1044**

**DA1045**

**DA1043**  
Front - includes filler plug  
Defender/Discovery 1  
Range Rover Classic/Series  
**DA1044**  
Rear - includes filler plug  
Defender 90/Discovery 1  
Range Rover Classic/Series  
**DA1045**  
Front & rear - excludes filler plug  
Series - early models

### Propshaft Bearings

**DA2395** Discovery 3/Discovery 4 for TVB500360  
**DA2428** Range Rover L322 for TVB500400  
**DA2427** Range Rover Sport - Mk1 for TVB500390

**DA2777**  
Freelander 2 for LR023283



Centre bearing assembly for rear propshafts. Instead of replacing your whole propshaft - just replace the centre bearing!

#### GKN Centre Bearings

**DA2395G** Discovery 3/Discovery 4 for TVB500360  
**DA2427G** Range Rover Sport - Mk1 for TVB500390

**GBH134GIRLING**  
Series 2 & Series 2A - 1959 - 1971  
**RTC5940GIRLING**  
Series 3 - 1971 - 1982

### Clutch Release Fork Kit



**576137KIT**  
Td5 engines

### Gear Lever Replacement Spring

**DA2826**  
Replacement spring for Freelander 2 gear lever LR052792.



Britpart

**IRD Repair Kit**



**DA6440**  
Freelander 1  
Repair kit for intermediate reduction drive assembly (TAG000230)

**MT82 Repair Kit**



**DA2720**  
Defender - 2007 onwards  
Repair kit for MT82 coupling flange & transfer box input shaft.

- > Coupling flange
- > Input shaft
- > Retaining ring
- > Special bolt
- > Oil seals
- > Seal retaining clip
- > Anti-seize grease

**Gearbox Bearing Kits**



**DA3364**  
**DA3361** Series 2 & Series 2A suffix B  
**DA3360** Series 2A suffix B & Series 3  
**DA3362** LT77 suffix A - E  
**DA3363** LT77 suffix F - G  
**DA3364** LT77 suffix H  
**DA3365** R380 suffix J  
**DA3366** R380 suffix K

**Gen3 Coupling Filters**



**DA5151G**  
**DA5151** Britpart OEM  
Freelander 2 - up to 8H999999  
The Gen3 coupling filter was never available from Land Rover, they only made the Gen4 available.

**CV Joint Kits**

**DA6050** Range Rover Classic - up to 1985  
**DA6051** Range Rover Classic - 1986 up to 1988 non-ABS axle suffix A up to EA305589  
**DA6052** Range Rover Classic - 1989 up to 1991 non-ABS axle suffix B from EA305590 up to HA610293  
Range Rover Classic - 1992 on non-ABS up to JA624755  
**DA6053** Range Rover Classic - 1986 up to 1991 with ABS up to HA610293  
**DA6054** 10 spline on half shaft to diff end  
Range Rover Classic - 1992 on non-ABS from KA624756 up to P38  
Range Rover Classic - 1992 on with ABS up to P38  
**DA6055** 24 spline on half shaft to diff end  
Range Rover Classic - 1992 on non-ABS from KA624756 up to P38  
Range Rover Classic - 1992 on with ABS to P38  
**DA6056** Range Rover P38 - 1995 up to 2002  
**DA2867** Rear inner CV joint to suit drive shaft TOB500330  
Range Rover L322 M57 3.0 diesel

**DA6057** 10 splines axle shaft to diff end  
Defender - non-ABS with 23 internal splines  
**DA6058** 10 splines axle shaft to diff end  
Defender - 1986 on non-ABS with 32 internal splines  
**DA6059** 24 splines axle shaft to diff end  
Defender - non-ABS and ABS models from LA up to 2007  
**DA6060** Discovery 1 - non-ABS up to JA32850  
**DA6061** 10 splines axle shaft to diff end  
Discovery 1 - non-ABS JA032851 onwards  
**DA6062** 24 splines axle shaft to diff end  
Discovery 1 - non-ABS - JA032851 onwards  
Discovery 1 - ABS models - JA032851 onwards  
**DA6063** Discovery 2  
**DA6064** Freelander 1 - up to YA999999 TCIE diesel and 1.8 petrol



Britpart has put together these boxed kits to help the fitter have all the necessary parts to do the job in one hit, saving time and money trying to find the necessary parts to do the job.

**Save time & money with a Britpart CV joint kit.**

These kits are also helpful to pass over the trade counter instead of having to hunt for the individual parts. One kit does one CV joint.



**Swivel Housing Kits**

**Note** Kit is for one side only.

For full details of each kit list - [www.britpart.com/swivelkits](http://www.britpart.com/swivelkits)

Discovery 1 - up to JA32850 - with 12mm seals  
Range Rover Classic - from 1985 up to JA624516 - with 12mm seals  
Contents - Swivel housing; swivel pin bearing; gasket; seals; plate; shims; joint washers; swivel pin upper & swivel housing grease sachet  
Discovery 1 - up to JA32850 - with 8mm seals  
Range Rover Classic - up to JA624516 - with 8mm seals  
Contents - Swivel housing; swivel pin bearing; gasket; oil seals; plate; shims; joint washers; swivel pin upper & swivel housing grease sachet  
Discovery 1 - JA32851 onwards - non-ABS  
Range Rover Classic - JA624517 onwards - non-ABS  
Contents - Swivel housing; swivel pin bearing; gasket; seals; plate; shims; joint washers; swivel pin upper - non-ABS & swivel housing grease sachet  
Discovery 1 - with ABS  
Range Rover Classic - with ABS  
Contents - Swivel housing; swivel pin bearing; gasket; seals; plate; shims; joint washers; swivel pin kit - upper - ABS & swivel housing grease sachet  
Defender - up to KA930455  
Contents - Swivel housing; housing and bush; thrust washer; swivel pin bearing; joint washers; seals; shims; swivel pin upper & swivel housing grease sachet  
Defender - from LA up to WA  
Contents - Swivel housing; swivel pin bearing; gasket; seals; plate; shims; joint washers; swivel pin upper - non-ABS & swivel housing grease sachet  
Defender - XA onwards - non-ABS  
Contents - Swivel housing; swivel pin bearing; gasket; seals; plate; shims; joint washers; swivel pin kit & swivel housing grease sachet  
Defender - XA onwards - with ABS  
Contents - Swivel housing; swivel pin bearing; gasket; seals; plate; joint washers; swivel pin kit & swivel housing grease sachet  
Series 2  
Contents - Swivel housing; swivel pin; railko bush; thrust washer; swivel pin bearing; o-ring; lock washer; locker; shims; oil seal; retainer for oil seal; joint washers & swivel housing grease sachet  
Series 2A/Series 3  
Contents - Swivel housing; swivel pin; railko bush; thrust washer; swivel pin bearing; o-ring; lock washer; locker; shims; oil seal; retainer for oil seal; joint washers & swivel housing grease sachet

**Blue Part Numbers**  
Full kit with swivel housing  
**DA3163**

**Red 'P' Part Numbers**  
Repair kit without swivel housing  
**DA3163P**

**Green 'G' Part Numbers**  
Full kit with swivel housing & OEM seals  
**DA3163G**

**DA3164**

**DA3164P**

**DA3164G**

**DA3165**

**DA3165P**

**DA3165G**

**DA3166**

**DA3166P**

**DA3166G**

**DA3167**

**DA3167P**  
**DA3167PG** OEM kit

**DA3167G**

**DA3178**

**DA3178P**  
**DA3178PG** OEM kit

**DA3178G**

**DA3179**

**DA3179P**  
**DA3179PG** OEM kit

**DA3179G**

**DA3180**

**DA3180P**  
**DA3180PG** OEM kit **NEW**

**DA3180G**

**DA3169**

**DA3169P**

**DA3181**

**DA3181P**



These swivel housing kits from Britpart are a convenient way to ensure you have all the quality parts needed to replace your swivel housing.



**Castor Corrected Swivel Housings**  
These are a direct replacement for vehicles normally using the FRC7065 swivel housing but they have the mounting holes positioned to give 3 degrees of additional castor. Full details in the suspension section.  
**DA3203** Based on DA3178 kit  
Defender - from LA up to WA  
**DA2992** Based on DA3165 kit  
Discovery 1 - JA32851 onwards - non-ABS  
Range Rover Classic - JA624517 onwards - non-ABS

**Corroded, worn or leaking swivel housings?**



### Gear Change Kits



DA1253

**DA1252**  
LT77 gearbox  
Range Rover Classic - up to LA  
Discovery 1 - up to LA  
**DA1253**  
R380 gearbox  
Range Rover Classic - MA onwards  
Discovery 1 - MA onwards  
Discovery 2

### Transfer Box Linkage Repair



DA3398

DA3399

**DA3398 NEW**  
Transfer box linkage repair kit - up to LA  
**DA3399 NEW**  
Transfer box linkage repair kit - MA onwards



Britpart

### Rear AWD Coupling Control Unit Parts



LR051320

Discovery Sport & Range Rover Evoque  
**LR051311**  
Differential bracket  
**LR051320**  
Oil reservoir cover  
**LR073537**  
AWD coupling control unit  
**LR073538**  
Coupling drive shaft & pump  
**LR073539**  
Differential and carrier



LR073537



LR051311



LR073538



LR073539

### Diff Overhaul Kits

**Freelander 2**  
Owners may report excessive noise, either humming, a rumble or high pitched white coming from the rear diff. These kits contain all you need to rectify that problem.

OEM rear diff pinion bearing overhaul kit with oils  
**DA7211** Freelander 2 - up to BH257090  
**DA7214** Freelander 2 - from BH257091

OEM rear diff pinion bearing overhaul kit  
**DA7211E** Freelander 2 - up to BH257090  
**DA7214E** Freelander 2 - from BH257091

OEM full rear diff pinion bearing overhaul kit with oils  
**DA7509** Freelander 2 - up to BH257090  
**DA7529** Freelander 2 - from BH257091

OEM full rear diff pinion bearing overhaul kit  
**DA7509E** Freelander 2 - up to BH257090  
**DA7529E** Freelander 2 - from BH257091

OEM front diff bearing overhaul kit  
**DA7213E** Freelander 2

**Discovery 3/Discovery 4**  
**Range Rover Sport - 2005 - 2013**  
**DA5039**

Front diff overhaul kit  
4 bearings & 3 main oil seals  
**DA5035**

Rear non-locking diff overhaul kit  
6 bearings & 3 main oil seals  
**DA5038**

Rear locking diff overhaul kit  
5 bearings & 3 main oil seals



Many more kit photos available online

DA7509

**Discovery 5/Range Rover Sport - 2014 - Range Rover L405**

**DA7216**  
Front diff overhaul kit

**DA7217**  
Rear diff overhaul kit



DA5039

DA7529E



### Rear Diff Assemblies



DA1216HD

**TVK000180E**  
Freelander 1  
Re-manufactured rear diff assembly

**DA1216HD**  
Freelander 2  
Re-manufactured diff with heavy-duty input nose bearing  
**DA1241**  
Range Rover Evoque - EH000001 onwards  
Dynamic Driveline rear diff carrier to replace LR052118



**TBB000270E**  
4-Pin Reconditioned Differential Rear  
Defender 110 & 130 - from 2A626835  
Range Rover P38

### Transfer Boxes



LR039783



LR052756

**IAB500104E**  
Defender - Prefix 57D  
Td5 from 3A  
**LR052756**  
Defender - 2007 onwards  
**LR039783**  
Freelander 2  
Range Rover Evoque

### Transfer Overhaul/Repair Kits



DA3205G

A complete OEM overhaul kit for the LT230 transfer box. Kit includes flanges, bearings and gaskets.

**DA3205G** Defender/Discovery 1  
**DA3215G** Discovery 2



**DA7215**  
Discovery 3 & Discovery 4  
Range Rover Sport  
Bearing & seal overhaul kit for DD295 transfer boxes  
> Main drive bearings  
> Rear output flange bottom needle bearing  
> Actuator shaft bearing  
> Drive flange snap rings  
> Input oil seal  
> Front & rear output oil seals

Degradation in oil can lead to judder, noise and a deterioration in gear change quality. It is recommended that oil and filters are changed after 50,000 to 75,000 miles on all 5, 6 & 8 speed automatic gearboxes to ensure optimum performance.

**6-Speed Filter Conversion Kit**

This is an easy change filter conversion kit for all vehicles with either a 6HP26 or 6HP28 ZF 6-speed automatic gearbox. From the factory a fluid and filter change on this transmission is a very lengthy process. The sump and filter are normally one piece and fitting involves jacking the engine up and unbolting the mounts, plus the removal of the exhaust.

Suitable for -  
Discovery 3 & Discovery 4  
Range Rover Sport - 2005 - 2013  
Range Rover L322

The fitting of this kit is far easier. Once the fluid has been drained from the transmission simply remove the bolts from the old unit. Cut the old plastic sumps filter tube with a hacksaw. Slide the old sump out and remove the other end of the sawn off filter tube. The new separate filter can then be fitted and the new sump pan slides into place and is bolted up with the new gasket supplied. Once secure the transmission can be filled as per manufacturer's instructions. The new sump pan also has the added benefit that it is manufactured in durable steel rather than the plastic of the original item - LR007474. Also see DA6085 & DA6085G in service kit section. 7 litres needed for oil change.

**Britpart Kit**

- DA2142 Filter conversion kit
- DA2143 Replacement filter
- DA2144 Replacement gasket
- TYK500050 Ravenol fluid - 1 litre

**OEM Kit**

- DA2142G Filter conversion kit - OEM
- DA2143G Replacement filter - OEM
- DA2144G Replacement gasket - OEM
- TYK500050G ZF Lifeguard fluid - 1 litre



**6-Speed Fluid Change Kit**

Automatic transmission fluid change kit for vehicles with either a 6HP26 or 6HP28 ZF 6-speed automatic gearbox. Ideal for high mileage vehicles and towing vehicles. Kit comprises of pan assembly, transmission fluid, screws, sleeve & plugs.

Suitable for -  
Discovery 3  
Discovery 4  
Range Rover Sport - 2005 - 2013  
Range Rover L322

- DA6085 Britpart pan with Ravenol oil
- DA6085G ZF pan with ZF oil



**5-Speed Gearbox Service Kit**



**8-Speed Fluid Change Kit**

Automatic transmission fluid change kits for vehicles with ZF 8HP70 8-speed automatic gearbox. Ideal for high mileage vehicles and towing vehicles. Kit comprises of pan assembly, transmission fluid, screws & plug.

Discovery Sport  
Discovery 4  
Range Rover Evoque - 2012 - 2018  
Range Rover Sport - 2010 - 2013  
Range Rover Sport - 2014 onwards  
Range Rover L322 - 2010 - 2012  
Range Rover L405

- DA3383G NEW OEM Pan (LR065238G) and ZF oil
- DA3383 NEW Pan (LR065238) and Ravenol oil



**4-Speed Gearbox Service Kit**



Photo by Marco Susenburger





Photo by Marco Susenburger





# LUCAS CLASSIC



Since the very first car wheel on the very first car hit the road over a hundred years ago, Lucas has been at the forefront of component manufacture and supply for both OE and the aftermarket. In fact, Lucas is the oldest continually trading automotive brand in the world.

Having been in business for 147 years means that we not only know a lot about vehicles today, but the vehicles of yesterday as well.

In the second half of the 20th century, you would have been hard pressed to find a vehicle on the road that didn't have some Lucas OE content, for electrical, diesel and braking. In fact, Lucas designed products are still used on new vehicles manufactured now.

Today, we're still at the top of our game as a global business. Our famous green boxes can be found in every corner of the world.

But for us, our heritage is vital, as it is what sets us apart from others. Hard won experience of innovating and providing quality parts that are durable and reliable, straight out of the box.

And now, we are celebrating that heritage with a new range of classic parts specifically designed for restorers, workshops and consumers who want to keep their classic vehicles faithful to the original by fitting Lucas parts developed, tested and engineered to the original specification. Now, you can have the real thing. Lucas Classic parts are often reproduced from original tooling, re-manufactured and re-engineered by trained experts following original Lucas product manuals and technical drawings.

## Lucas. Classics live forever.

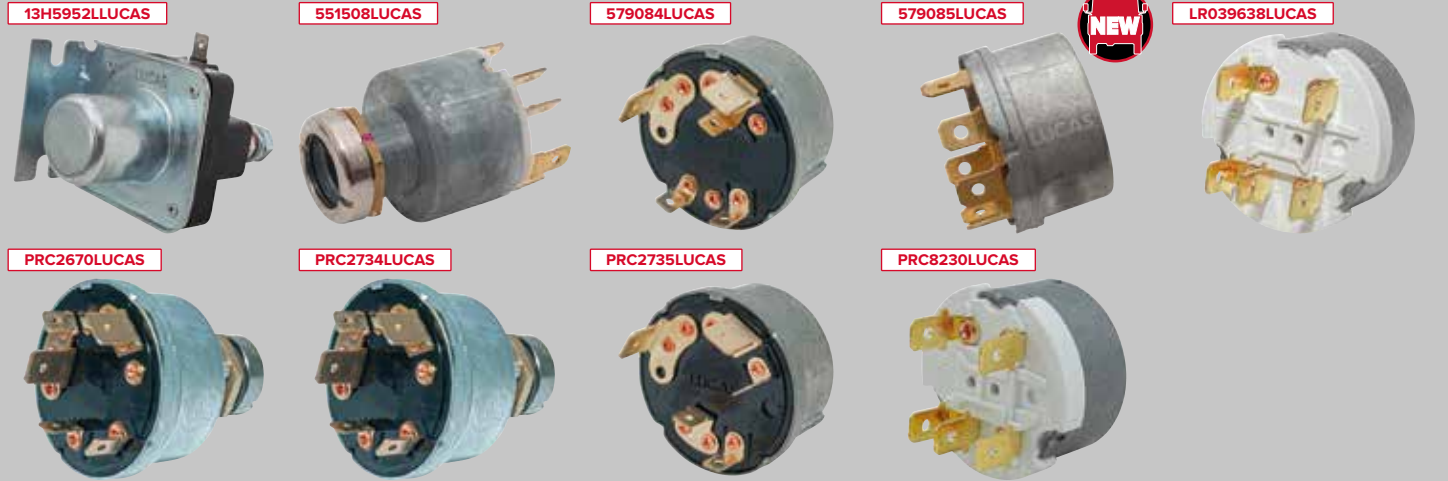

### Switches - Ignition

<b>13H5952LUCAS</b>	Switch - Starter solenoid	Series 2/Series 2A & Series 3
<b>551508LUCAS</b>	Switch - Ignition	Series 2A/Series 3 & Early 90/110
<b>579084LUCAS</b>	Switch - Ignition	Series 3 - Diesel
<b>579085LUCAS NEW</b>	Switch - Ignition - without Interlock starter	Series 3 Petrol & 90/110 Petrol to FA415402
<b>LR039638LUCAS</b>	Switch - Ignition	90/110 - Petrol from FA415403 & all diesel 1994 onwards
<b>PRC2670LUCAS</b>	Switch - Ignition	Series 3 - Diesel - for vehicles without steering column lock
<b>PRC2734LUCAS</b>	Switch - Ignition	90/110 - Diesel - without steering column lock
<b>PRC2735LUCAS</b>	Switch - Ignition	90/110 (not Defender) - Diesel
<b>PRC8230LUCAS</b>	Switch - Ignition	90/110 (not Defender)



### Warning Lights - \*Bulb and bulb holder not included

<b>238018LUCAS</b>	Red with black bezel	Series 1
<b>238019LUCAS</b>	Green with black bezel	Series 1
<b>238020LUCAS</b>	Amber with black bezel	Series 1
<b>519740LUCAS</b>	Oil - Green light*	Series 2 & Series 2A
<b>519742LUCAS</b>	Fuel - Blue light*	Series 2 & Series 2A
<b>519743LUCAS</b>	Charge - Red light*	Series 2 & Series 2A
<b>519744LUCAS</b>	Choke - Amber light*	Series 2 & Series 2A
<b>559322LUCAS</b>	Amber trailer light lens	Series 3 & 101 Forward Control
<b>575396LUCAS</b>	Blue fuel level warning light lens	Series 3
<b>579007LUCAS</b>	Red ignition warning light lens	Lightweight
<b>589027LUCAS</b>	Green flasher warning light lens	101 Forward Control



If you're keeping a classic vehicle on the road, keep it authentic as well.

Authentic Classic Range

**274783LUCAS**



**505196LUCAS**



**514148LUCAS**



**514150LUCAS**



**572704LUCAS**



**572715LUCAS**



**589284LUCAS**



**589285LUCAS**



**DA3208LUCAS**



**RTC210LUCAS**



**Lights & Lenses**  
**274783LUCAS**

Classic Lucas LUB300 7" headlight unit  
To fit BPF type bulbs - see bulb 505196LUCAS

Series 1, 2, 2A & 3 - Right hand drive

**505196LUCAS**

Bulb - BPF / 12V / 50/40W

1951-1967 vehicles using BPF headlights

**514148LUCAS**

Lens glass - Clear - Front side light

Series 2 - suffix A

**514150LUCAS**

Lens glass - Clear - L638

Series 2 - original style side light lens for Series 2

**572704LUCAS**

Lens glass - Red - L488

Series 2

**572715LUCAS**

Lens glass - Amber - L488

Series 2

**589284LUCAS**

Lens glass - Clear - Front side light

Series 2A & Series 3

**589285LUCAS**

Lens glass - Amber - Indicator

Series 2A & Series 3

**DA3208LUCAS**

Headlight bowl kit - Steel - pair

Series 1, 2 & 3, Defender & Range Rover Classic

**RTC210LUCAS**

Lens glass - Red - Stop/tail light

Series 3 - 1973 onwards & 90/110/130 up to LA

**AEU1610LUCAS**

Front indicator lens - Right hand side

Range Rover Classic

**AEU1609LUCAS**

Front indicator lens - Left hand side

Range Rover Classic

**RTC4590LUCAS**

Rear light lens assembly with black border - Right hand side

Range Rover Classic

**RTC4591LUCAS**

Rear light lens assembly with black border - Left hand side

Range Rover Classic

**RTC4588LUCAS**

Rear light lens side with black border - Right hand side

Range Rover Classic

**RTC4589LUCAS**

Rear light lens side with black border - Left hand side

Range Rover Classic

**RTC5989LUCAS**

Rear light lens assembly - Right hand side

Range Rover Classic

**RTC5990LUCAS**

Rear light lens assembly - Left hand side

Range Rover Classic

**RTC5294LUCAS**

Rear light lens side - Right hand side

Range Rover Classic

**RTC5295LUCAS**

Rear light lens side - Left hand side

Range Rover Classic

**AEU1610LUCAS**



**RTC4590LUCAS**



**RTC4588LUCAS**



**RTC5989LUCAS**



**RTC5294LUCAS**







### Switches - Other

<b>1H9077LUCAS</b>	Switch - Heater	Series 3
<b>502096LUCAS</b>	Switch - Flasher unit	Series 2, Series 2A & Series 3
<b>510267LUCAS</b>	Switch - Military twin tank changeover	Series 1, Series 2, Series 2A & Series 3
<b>575383LUCAS</b>	Switch - Indicator/horn & headlight dip	Series 3
<b>589884LUCAS</b> <b>NEW</b>	Switch - Indicator/horn & headlight dip	Range Rover Classic - 1970 - 1980
<b>90519864LUCAS</b>	Switch - Oil pressure	Series - 2.25 petrol & diesel and 2.6 petrol up to 1984
<b>AMR6106LUCAS</b>	Switch - Windscreen wash/wipe	90/110/130 VA104806 onwards
<b>PRC2911LUCAS</b>	Switch - Diff lock & reverse light switch	Defender - LT230 (Diff lock) & LT77 up to 2A642630
<b>PRC3875LUCAS</b>	Switch - Indicator/horn & headlight dip	Discovery 1 - LT230 (Diff lock) & LT77 up to LA081991
<b>PRC3900LUCAS</b>	Switch - Windscreen wash/wipe - type 164SA	Discovery 2 - LT230 (Diff lock) & LT77 up to 2A999999
<b>PRC5072LUCAS</b>	Switch - Indicator/horn & headlight dip	Range Rover Classic - LT230 (Diff lock) & LT77
<b>PRC5436LUCAS</b>	Switch - Heater 4-position	90/110/130 to GA455945
<b>PRC5610LUCAS</b>	Switch - Wiper toggle	90/110/130 up to GA455945
<b>PRC6387LUCAS</b>	Switch - Oil pressure	Range Rover Classic - 1986 - 1994
<b>PRC7370LUCAS</b>	Switch - Wiper	Range Rover Classic & Discovery 1
<b>PRC8876LUCAS</b> <b>NEW</b>	Switch - Flasher unit	Series 2A
<b>STC4104LUCAS</b> <b>NEW</b>	Switch - Oil Pressure V8	90, 110 & 130 - 4 cylinder petrol & diesel
<b>STC439LUCAS</b>	Switch - Indicator/horn & headlight dip	Range Rover Classic - 2.5 VM diesel
<b>STC4793LUCAS</b>	Switch - Flasher unit	Defender - from HA455946 to VA104805
<b>STC865LUCAS</b>	Switch - Indicator/master lighting & headlight dip	Defender - 1987 - 2006/Range Rover Classic - 1986 - 1994
<b>XPB101290LUCAS</b>	Switch - Indicator/horn & headlight dip	Defender - V8 up to 2006/Range Rover P38 - V8 - up to 2001
		Discovery 2 - V8
		90/110/130 HA455946 to VA104805
		Series 3/90/110/130 - up to LA939975
		Discovery 1
		90/110/130 from WA138480

### XPB101290LUCAS



*If you're keeping a classic vehicle on the road, keep it authentic as well.*



**Authentic Classic Range**



### Switches - Lights

<b>07160LUCAS</b>	Switch - Brake light	Series 1
<b>232026LUCAS</b> <b>NEW</b>	Switch - Floor mounted dip switch	Series 1 - 1955 onwards
<b>13H3735LLUCAS</b>	Switch - Brake light	Series, Discovery 1, Range Rover Classic
<b>1H9077LLUCAS</b>	Switch - Headlight & side	Series 2A & Series 3 - 1967-1984
<b>575166LUCAS</b>	Switch - Brake light	Series 2A & Series 3
<b>575383LUCAS</b>	Switch - Headlight dip/indicator & horn	Series 3
<b>589884LUCAS</b> <b>NEW</b>	Switch - Headlight dip/indicator & horn	Range Rover Classic - 1970 - 1980
<b>90575281LUCAS</b> <b>NEW</b>	Switch - Hazard warning lights	Series 3/Range Rover Classic
<b>AMR3918LUCAS</b>	Switch - Reverse light	Defender, Discovery 1 & 2,
<b>AMR6104LUCAS</b>	Switch - Headlight	Range Rover Classic - R380 gearbox
<b>CDU511LUCAS</b>	Switch - Reverse light	90/110/130 VA104806 onwards
<b>PRC2911LUCAS</b>	Switch - Reverse light & diff lock & switch	Freelander 1 - manual transmission 1.8 petrol & 2.0TCie diesel
<b>PRC3430LUCAS</b>	Switch - Headlight	Defender - LT230 (Diff lock) & LT77 up to 2A642630
<b>PRC3432LUCAS</b> <b>NEW</b>	Switch - Rear fog light	Discovery 1 - LT230 (Diff lock) & LT77 up to LA081991
<b>PRC3875LUCAS</b>	Switch - Headlight dip/indicator & horn	Discovery 2 - LT230 (Diff lock) & LT77 up to 2A999999
<b>PRC5072LUCAS</b>	Switch - Headlight dip/indicator & horn	Range Rover Classic - LT230 (Diff lock) & LT77
<b>PRC5425LUCAS</b>	Switch - Headlight	90/110/130 to VA104805
<b>RTC430LUCAS</b>	Switch - Panel light	90/110 & Defender - up to 1995
<b>STC439LUCAS</b>	Switch - Headlight dip/indicator & horn	90/110/130 to GA455945
<b>STC865LUCAS</b>	Switch - Headlight dip/indicator & master lighting	Range Rover Classic - 1986 - 1994
<b>XPB101290LUCAS</b>	Switch - Headlight dip/indicator & horn	Range Rover Classic
<b>YUF101490LUCAS</b> <b>NEW</b>	Switch - Hazard warning lights	Series 2A & Series 3
		90/110/130 HA455946 to VA104805
		Discovery 1
		90/110/130 from WA138480
		90/110/130 up to 2006







### Ignition Leads & Components

Lucas Classic ignition leads provide a high quality silicone ignition lead for modern reliability but with a classic look.

<b>ERC3256LUCAS</b>	Ignition leads - 2.25l & 2.5l 4 cylinder petrol	Series 2A, Series 3 & 90/110
<b>NGC103LUCAS NEW</b>	Ignition leads - Thor V8	Discovery 2/Range Rover P38 - 1994 - 2001
<b>RTC6551LUCAS</b>	Ignition leads - 3.5 V8 petrol	90/110, Range Rover Classic & Discovery 1
<b>STC9124LUCAS</b>	Ignition lead with cover - V8 petrol	Range Rover Classic & Discovery 1
<b>DLB102LUCAS NEW</b>	Ignition coil - ballast 12V standard type	For use with a 1.6 ohm ballast resistor
<b>DLB105LUCAS</b>	Ignition coil - 2.25l & 2.5l - Sports version of PRC9858	Series 2, Series 2A, Series 3, 90, 110
<b>DLB110LUCAS NEW</b>	Ignition coil - ballast 12V high performance type	For use with a 1.6 ohm ballast resistor
<b>PRC9858LUCAS</b>	Ignition coil - 2.25l & 2.5l	Series 2, Series 2A, Series 3, 90, 110
<b>RTC5628LUCAS NEW</b>	Ignition coil - non-ballast 12V type - Rover V8 engines	Defender - 1987 - 2006, Discovery 1, Range Rover Classic - 1986-1994
<b>RTC3278LUCAS NEW</b>	Distributor cap - petrol engines with Lucas 45D distributor	Series 2A & Series 3
<b>RTC3471LUCAS NEW</b>	Condenser	Series 3 - 2.25 Petrol - 1980 onwards
<b>RTC3472LUCAS</b>	Condenser	Series 1, 2 & 3, Defender & Range Rover Classic
<b>RTC6621LUCAS NEW</b>	Condenser - Long Lead Type	Series 3 - 2.25 Petrol
<b>RTC3612LUCAS</b>	Rotor arm - non-riveted construction	Later Series 1 & Early Series 2



**Fuse Block**  
**PRC4826LUCAS NEW**  
 Supplied with 40 connectors  
 Defender - 1987 - 2006



**Junction Box Cover**  
**3971LUCAS NEW**  
 6J Junction box cover  
 Series 1 - 1948 - 1958



**Authentic Classic Range**

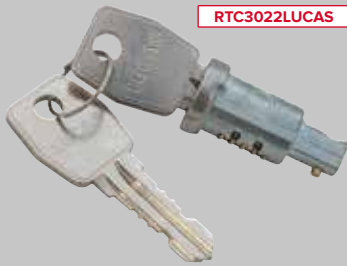

**RTC3022LUCAS**



**LR077439LUCAS**

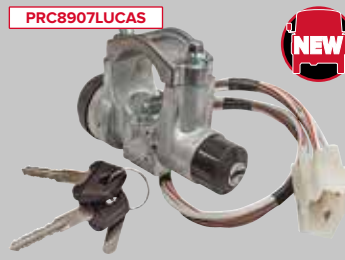

**PRC8907LUCAS**



**STC1435LUCAS**

**Ignition & Steering Locks**

<b>RTC3022LUCAS</b>	Key barrel & key	90/110/130 up to 1A622423
<b>LR077439LUCAS</b> <b>NEW</b>	Steering column & ignition lock	Defender - 200Tdi onwards
<b>PRC8907LUCAS</b> <b>NEW</b>	Steering column & ignition lock	Range Rover Classic
<b>STC1435LUCAS</b>	Steering column & ignition lock	Discovery 1 & Range Rover Classic
<b>QRF100870LUCAS</b>	Steering column & ignition lock	90/110 - 2.5 N/A Diesel & 2.5TD

*If you're keeping a classic vehicle on the road, keep it authentic as well.*



**QRF100870LUCAS**

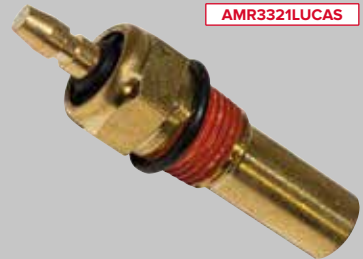

**AMR3321LUCAS**



**ETC8496LUCAS**

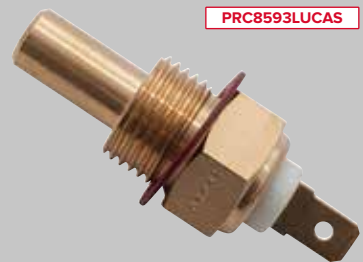

**PRC8593LUCAS**

**Sensors**

- ETC8496LUCAS** **NEW**  
Sensor - Water temperature  
Rover V8 Efi engines

---

- PRC8593LUCAS**  
Sensor - Water temperature  
200Tdi engines

---

- AMR3321LUCAS**  
Sensor - Water temperature  
300Tdi engines





### Girling Classic Shock Absorbers

<b>RTC4230GIRLING</b>	Front	Defender 90 - up to WA159806	Front	<b>RTC4442GIRLING</b>
Series 1 - 1954 - 1958, Series 2, Series 2A & Series 3 - Short wheel base				
<b>RTC4232GIRLING</b>	Rear	Defender 90 - up to XA159806	Rear	
Series 1, Series 2, Series 2A & Series 3 - Short wheel base				
<b>RTC4442GIRLING</b>	Rear	Defender 110 & 130 - up to WA15906	Front	
Series 2, Series 2A & Series 3 - Long wheel base				
<b>RTC4483GIRLING</b>	Front	Defender 110 with self levelling suspension - up to WA159806	Rear	
Series 2, Series 2A & Series 3 - Long wheel base				
<b>RTC4484GIRLING</b>	Front	Defender 110 with normal duty suspension less self levelling suspension - up to WA159806	Rear	
Series 3 with heavy-duty suspension - Long wheel base				
<b>STC2829GIRLING</b>	Front	Defender 110 with heavy-duty suspension less self levelling suspension - up to WA159806	Rear	
Range Rover Classic - from MA660164				
<b>STC2831GIRLING</b>	Rear	Defender 130 - up to WA159806	Rear	
Range Rover Classic from MA660164				
<b>STC3671GIRLING</b>	Rear	Discovery 1 - up to LA081991	Rear	
Range Rover P38 with air suspension - from VA348054				
<b>STC3672GIRLING</b>	Front	Discovery 1 - up to HA472849	Rear	
Range Rover P38 with air suspension - from VA348054				
<b>STC3703GIRLING</b>	Front	Range Rover Classic - up to GA417084		
Discovery 1				
<b>STC3704GIRLING</b>	Rear	Steering Damper		
Discovery 1 - from MA081992		<b>RTC4472GIRLING NEW</b>		
		Defender - 1987 - 2016		



**RTC4232GIRLING**



Many more images available online at [lucasclassic4x4.com](http://lucasclassic4x4.com)

*These traditional hydraulic shock absorbers come with fluid and seal technology designed to keep your Land Rover suspension under control.*

## Braking & Clutch

### Girling Classic Brake Hoses

<b>219824GIRLING</b>	Front & Rear	Series 1 - 1948 - 1953
<b>577681GIRLING</b>	Front	Series 3 - 1 Ton - 1971 - 1980
<b>NRC4402GIRLING</b>	Rear	Series 3 - Long wheel base - 1980 - 1984
<b>NRC9457GIRLING</b>	Front	Series 3 - Short & long wheel base - 1980 - 1984
<b>NRC9458GIRLING</b>	Rear	Series 3 - Short wheel base - 1980 - 1984
<b>RTC3353GIRLING</b>	Rear	Series 3 - Long wheel base - 1971 - 1980
<b>RTC3386GIRLING</b>	Front	Series 2 & Series 2A - Short & long wheel base - 1954 - 1971
<b>RTC5903GIRLING</b>	Rear	Series 1, Series 2, Series 2A & Series 3 - Short wheel base - 1954 - 1980
	Front	Series 3 - Short & long wheel base - 1971 - 1980



### Girling Classic Clutch Hoses

<b>GBH134GIRLING</b>	Series 2 & Series 2A - 1959 - 1971
<b>RTC5940GIRLING</b>	Series 3 - 1971 - 1982

**219824GIRLING**



### Girling Classic Brake Caliper Repair Kits

<b>AEU2539GIRLING NEW</b>	Front	110 & 90 - from HA701010
<b>STC1270GIRLING NEW</b>	Rear	110 - up to 1A614447
<b>SMN000060GIRLING NEW</b>	Rear	110 - from 1A614448

**AEU2539GIRLING**

**STC1270GIRLING**



Girling Classic Brake Fluid Reservoir  
**90577636GIRLING**  
Series 3  
101 Forward Control

# GIRLING

Authentic Classic Range



# CHASSIS & BODY

**Bent Or Rusted...  
Replace It!**



### Chassis - Richards

<b>DA2056</b>	Defender 90	Nat. asp./2.5 Td & petrol/200Tdi
<b>DA2056-300TDI</b>	Defender 90	300Tdi
<b>KVD500710</b>	Defender 90	Td5
<b>DA8906</b>	Defender 90	2007 onwards
<b>DA2057*</b>	Defender 110	Nat. asp./2.5 Td/200Tdi
<b>DA2057-300TDI*</b>	Defender 110	300Tdi
<b>KVD500730</b>	Defender 110	Td5
<b>DA8907</b>	Defender 110	2007 onwards
<b>DA8900</b>	Discovery 2	Td5 - RHD - Up to 3A
<b>DA8901</b>	Discovery 2	Td5 - RHD - 3A onwards
<b>NRC4642G</b>	Series 3 - SWB	Uniframe chassis
<b>NRC4356</b>	Series 3 - LWB	4-door 4-cylinder Station Wagon
<b>DA5300</b>	Defender 90/110 - excludes 300Tdi	Bolt on crossmember - galvanised with fittings

### Richards Chassis

All Richards chassis are manufactured in the UK, using locally sourced materials and locally based machine shops. They are located close to the steel city, Sheffield, and therefore optimise the use of local steel, ensuring that all their chassis are formed from 2.5mm British steel which are all galvanised as standard. All profiling is done 'in house' using their own laser machine, enabling them to have greater control over the quality of parts used and the materials that they are formed from. The chassis are made using 2.5mm side rails which are 25% heavier than the standard 2.0mm rails. Overall this gives a small increase in the vehicle weight but has a massive effect on the long term durability of the chassis. Bolt on crossmembers are not supplied with Richards chassis but are available separately - see DA5300.

More pictures online at  
[www.britpart.com/chassis](http://www.britpart.com/chassis)

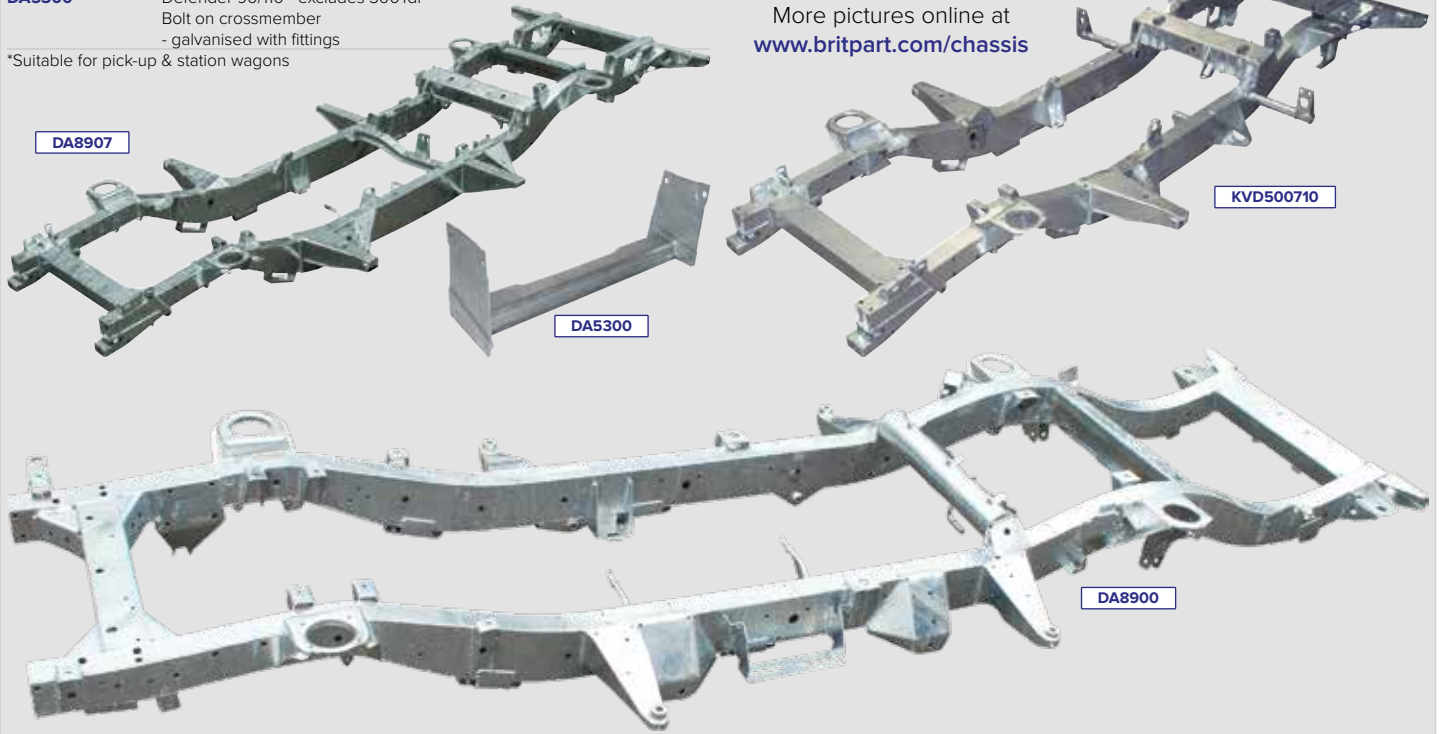

\*Suitable for pick-up & station wagons



### Important

This is a selection of the chassis' that we do. Please enquire if the chassis you require is not listed here.

### Chassis - Marsland

<b>NRC4642G-M</b>	Series 2A/Series 3 - SWB	4-cylinder
<b>DA2056-M</b>	Defender 90	Nat. asp./2.5 Td & petrol/200Tdi
<b>DA2056-300TDI-M</b>	Defender 90	300Tdi
<b>KVD500710-M</b>	Defender 90	Td5
<b>DA8906-M</b>	Defender 90	2007 onwards
<b>DA2057-300TDI-M</b>	Defender 110	300Tdi
<b>KVD500730-M</b>	Defender 110	Td5
<b>DA8907-M</b>	Defender 110	2007 onwards
<b>DA5300</b>	Defender 90/110 - excludes 300Tdi Bolt on crossmember - galvanised with fittings	

#### Marsland Chassis

The Marsland Defender chassis manufactured by GKN Wheels & Structures, supplied with an insurance accepted GKN Certificate of Authenticity confirming the chassis are constructed using "the same materials, processes and quality control techniques as were stipulated at the time of original equipment manufacturer". Type approved and crash tested. All Defender chassis are built to 2016 type/latest specification, including rear cross member and A-frame cross member. GKN pressed 'C' section main legs/rails made from 2mm steel with 3mm stiffeners fitted and spot welded internally for added strength, effectively giving you 5mm of material where most needed. Chassis supplied with bolt in gearbox cross member, rear cross member to body bracket, A-frame to chassis bushes including fixings. Power steering pipe, fuel filter, fuel tank and fuel line riv nuts fitted to chassis. All holes drilled and tapped excluding rear tow pack holes. Galvanised as standard.

More pictures online at  
[www.britpart.com/chassis](http://www.britpart.com/chassis)

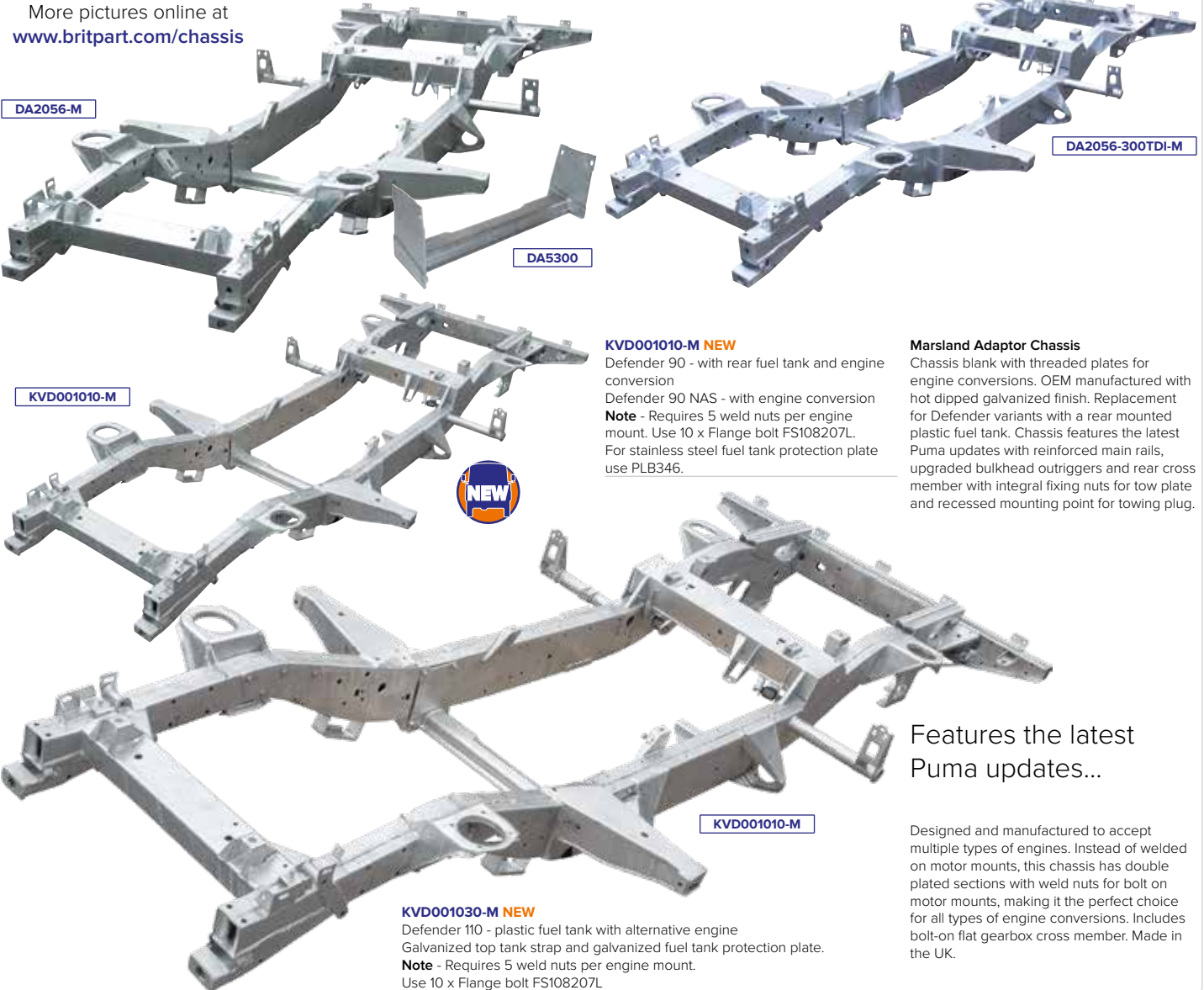

**DA2056-M**

**DA2056-300TDI-M**

**DA5300**

**KVD001010-M**

#### KVD001010-M NEW

Defender 90 - with rear fuel tank and engine conversion  
Defender 90 NAS - with engine conversion  
**Note** - Requires 5 weld nuts per engine mount. Use 10 x Flange bolt FS108207L.  
For stainless steel fuel tank protection plate use PLB346.

#### Marsland Adaptor Chassis

Chassis blank with threaded plates for engine conversions. OEM manufactured with hot dipped galvanized finish. Replacement for Defender variants with a rear mounted plastic fuel tank. Chassis features the latest Puma updates with reinforced main rails, upgraded bulkhead outriggers and rear cross member with integral fixing nuts for tow plate and recessed mounting point for towing plug.



**KVD001010-M**

#### KVD001030-M NEW

Defender 110 - plastic fuel tank with alternative engine  
Galvanized top tank strap and galvanized fuel tank protection plate.  
**Note** - Requires 5 weld nuts per engine mount.  
Use 10 x Flange bolt FS108207L

Features the latest Puma updates...

Designed and manufactured to accept multiple types of engines. Instead of welded on motor mounts, this chassis has double plated sections with weld nuts for bolt on motor mounts, making it the perfect choice for all types of engine conversions. Includes bolt-on flat gearbox cross member. Made in the UK.

### Chassis - Rear Half



**DA6648**

**DA6668**

**DA6670**

**DA2099**

**DA6669**

<b>DA2099</b>	Series 2 & 3 - SWB	
<b>DA6648</b>	Defender 90	200Tdi & 300Tdi
<b>DA6669</b>	Defender 110	200Tdi & 300Tdi
<b>DA6668</b>	Defender 90	Td5
<b>DA6670</b>	Defender 110	Td5
<b>DA2565</b>	Discovery 2	
<b>DA8903</b>	Discovery 2 - ¼ chassis	



# CHASSIS & BODY

## Galvanised & Stainless Steel Products

### Galvanised Products



**DA5681**  
Heavy-duty Steel Winch Bumper  
Suitable for DB12000i, DB9500i & DB9000C winches  
Defender - non air-con



**DPB000270GALV**  
Military Front Bumper  
Defender



**NRC9211**  
Front Bumper  
Defender



**564704 NEW**  
Front Bumper  
Series 2/Series 2A/Series 3



**RTC4769**  
Front Bumperette  
Defender/Series



**DA1188**  
Front Mudflap Brackets  
Equivalent to MTC3000 & MTC3001  
Defender 90/110



**DA1187**  
Rear Mudflap Brackets  
Equivalent to MUC3986 & MUC3987  
Defender 90



**DA2950 NEW**  
Rear Mudflap Brackets  
Equivalent to brackets for CAT500340 & CAT500350  
Defender 110/130



**CAX100060GALV NEW** Right hand side  
**CAX100070GALV NEW** Left hand side  
Front Mudflap Brackets  
Discovery 2



**CAX100200GALV NEW** Right hand side  
**CAX100210GALV NEW** Left hand side  
Rear Mudflap Brackets  
Discovery 2



**CNG100020GALV NEW** Right hand side  
**CNG100030GALV NEW** Left hand side  
Rear Mudflap Bracket Stays  
Discovery 2



**MTC4290GALV NEW**  
Rear End Door Seal Retainer  
Defender - 1987 - 2016



**DA1186**  
Front Shock Absorber Turrets  
Standard height pair with fitting kit  
Defender/Discovery 1/Range Rover Classic



**NRC6372GALV**  
Front Shock Absorber Turret  
Standard height  
Defender/Discovery 1/Range Rover Classic



**DA1215**  
Rear Spring Seat Fitting Kit  
Defender - 90/Discovery 1  
Range Rover Classic



**DA1233**  
Rear Spring Seat Fitting Kit  
Defender - 110/130



**NRC9700GALV**  
Spring Seat  
Defender/Discovery 1/Range Rover Classic



**DA1965**  
Rear Dislocation Cone Fitting Kit  
Defender 110



**DA2250GALV**  
Bolt-on Diff Guard  
Defender/Discovery 1/Range Rover Classic



**DA1830**  
Universal Chassis to Seatbelt Bracket  
Defender 90 & 110



Photo by Darren Whitley

### Galvanised Products



**ANR3713G**  
Gearbox Crossmember  
Defender - 300Tdi



**DA5300**  
Bolt-on Crossmember with Fittings  
Defender 90/110 - excludes 300Tdi



**NRC4171GALV**  
Bolt-on Centre Crossmember  
Defender - Station wagon & crew cab



**AFC710010GALV**  
Rear Tub Floor Reinforcement Crossmember  
Defender/Series



**DA1860**  
Front Brake Mud Shields  
Equivalent to FTC4838 & FTC4839  
Defender - from LA930456/Discovery 1



**DA2860**  
Front Brake Mud Shields  
Defender - up to KA930455  
Equivalent to FRC6402 & FRC6403



**LR017960GALV NEW** Right hand side  
**LR017961GALV NEW** Left hand side  
Rear Brake Mud Shields  
Defender - 2007 - 2016



**LR019162GALV** Right hand side  
**LR019163GALV** Left hand side  
Capping Body Side Finisher - One Piece  
Defender 2007 - 110 Station Wagon

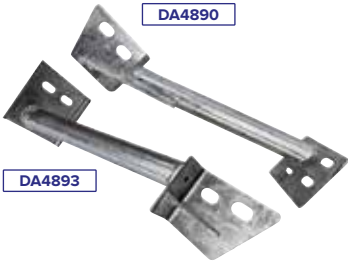

**DA4891** Right hand side  
**DA4890** Left hand side  
Defender 90 - up to 2006  
**DA4893** Right hand side  
**DA4892** Left hand side  
Rear Tubular Seat Belt to Chassis Bracket  
Defender 90 - up to 2006



**DA4895** Right hand side  
**DA4894** Left hand side  
Equivalent to EWQ500080  
Defender 90 - Td5 onwards  
Front Centre Seatbelt Bracket Under Seat Box

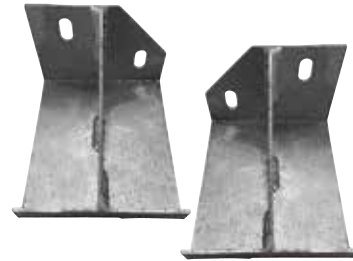

**DA4897**  
Reinforcing Bracket Truck Cab Base  
Equivalent to MTC2224 (right hand side) & MTC2225 (left hand side)  
Defender 110/130 Hi-Cap



**DA4896**  
Rear Body Bracket Mounting Rear Cab Base  
Equivalent to MTC2106 (right hand side) & MTC2107 (left hand side)  
Defender 110/130 Hi-Cap

Made from mild steel and hot dipped galvanised. Machine cut and CNC pressed for accuracy. Ready to bolt in place. **Note** - Please be aware there are some imperfections, i.e. excessive galv and in some instances where there was too much excessive galv, they have been flattened off before reaching mild steel and cold galv spray has been applied.



**KVU101420GALV**  
Rear Body Lower Chassis to Frame Mounting Bracket  
Fits both right hand side & left hand side  
Defender 110 & 130 Hi-Capacity pickup



**MTC3481GALV** Right hand side  
**MTC3482GALV** Left hand side  
Rear Body Lower Mounting Brackets  
Defender 110 & 130 Hi-Capacity pickup



**MUC9220GALV**  
Mounting Stay - Rear Lower Body  
Defender 90 - 1987 - 2006



**NRC9474GALV**  
Fuel Tank Rear Mounting Bracket  
Defender - 1987 - 2009



Photo by Kristian Kristjansson

Added protection  
for your Land Rover  
for years & years  
to come

**MUC8730 COMING SOON** Right hand side  
Equivalent to LR061990  
**MUC8731 COMING SOON** Left hand side  
Equivalent to LR062011  
Rear Body Tailgate Latch Capping  
Defender 90 & 110

**MUC9154 COMING SOON** Right hand side  
Equivalent to LR062003  
**MUC9155 COMING SOON** Left hand side  
Equivalent to LR062009  
Rear Body Inner Corner Capping Rear Door  
Type  
Defender 90 & 110



# CHASSIS & BODY

## Galvanised & Stainless Steel Products

### Stainless Steel Products

#### Stainless Steel Door Threshers

Defender - from 1983 onwards & Series 2 & 3

These stainless steel door threshers will freshen up the inside of your Land Rover as this is an area which can get very scruffy. All of the existing holes on the sills line up with these door threshers so they are a quick, easy bolt on project. The door threshers are made from stainless steel 304 grade bright annealed 1.5mm thick and are laser cut and CNC pressed. Stainless steel fixings are supplied. **Note** - If your door seal is fitted to your sill rail, you may need to modify the sill rail.

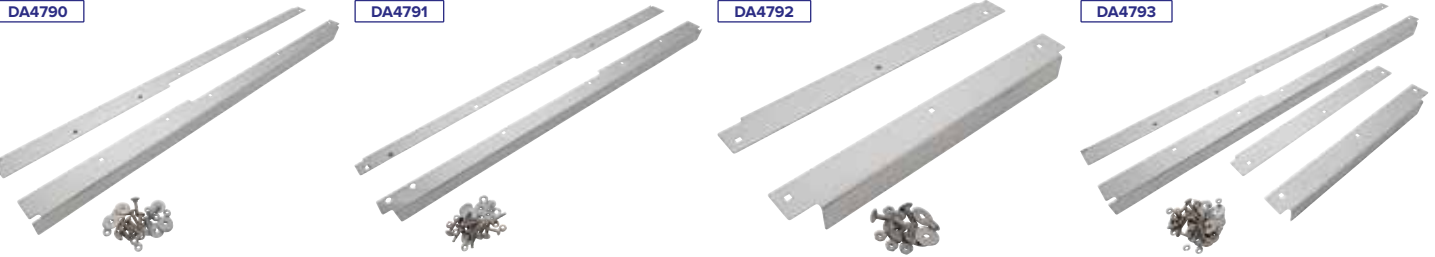

DA4790

DA4791

DA4792

DA4793



DA4794

#### Front & Rear Doors

**Stainless Steel**

**DA4790**

Front door threshers

For vehicles without sill seat belt mounts

**DA4791**

Front door threshers

For vehicles with sill seat belt mounts

**DA4792**

2nd row door threshers

**Brushed Stainless Steel**

**DA4790B**

Front & 2nd row door threshers

For vehicles without sill seat belt mounts

**DA4791B**

Front & 2nd row door threshers

For vehicles with sill seat belt mounts

**DA4792B**

**Front & Rear Door Kits**

**Stainless Steel**

**DA4793**

Front & 2nd row door threshers

For vehicles without sill seat belt mounts

**DA4794**

Front & 2nd row door threshers

For vehicles with sill seat belt mounts

**Brushed Stainless Steel**

**DA4793B**

Front & 2nd row door threshers

For vehicles without sill seat belt mounts

**DA4794B**

Front & 2nd row door threshers

For vehicles with sill seat belt mounts

Added protection for your Land Rover for years & years to come

SHU100340SS

#### Brake Pipe Swivel Mount Brackets

Laser cut 316 grade stainless steel.

Defender - up to WA159806

**DA1394** Front LHS

**DA1395** Front RHS

Defender - from 4A638618

**SHU000040SS** Front RHS

**SHU000050SS** Front LHS

Defender - from XA159807

**SHU100340SS** Rear



DA1394



SHU000040SS



SHU100340SS

These 'P' sections fit Series vehicles and early Defenders (where the door seal is fitted to the sill rail).



#### DA7370 NEW

#### Steel Seat Box Protectors

Defender

Pair

The edge of the Defender seat box is prone to damage, protect that edge and smarten up your interior with these protectors. Made from 2mm brushed stainless steel. Less than 5 minutes to fit and all you need is a drill for the fixings. Kit includes a pair of corner protectors and 8 x 19mm flanged steel self drill fixings. These will also fit a Series 2 & 3 but will require matching drilling to accommodate seat rail fixing.

**DA1396**  
**Swivel Pin/Mudshield Bracket**  
Defender/Discovery 1/Range Rover Classic  
Laser cut, folded, 2mm thick 316 grade stainless steel.

**DA4789**  
**Rear Brake Shield Bracket**  
Defender/Discovery 1/Range Rover Classic  
Laser cut, 3mm thick 316 grade stainless steel. Single. Equivalent to LR017513 & FTC3299.

**DA1722**  
**Door Rubber Seal Holders**  
Defender 110/Series LWB  
Front & 2nd row Made from 1mm stainless steel, laser cut and CNC pressed for accuracy.



Photo by Bogdan Muscalu

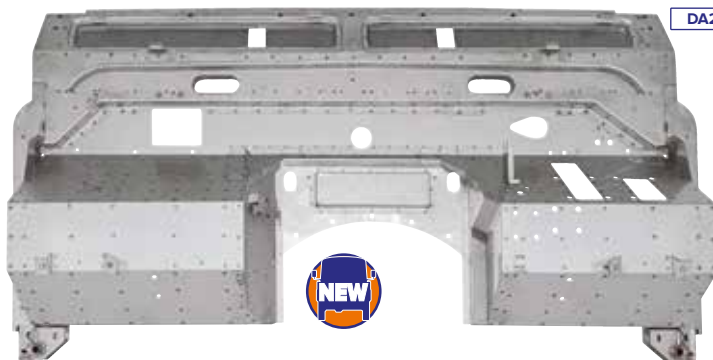

DA2971SS

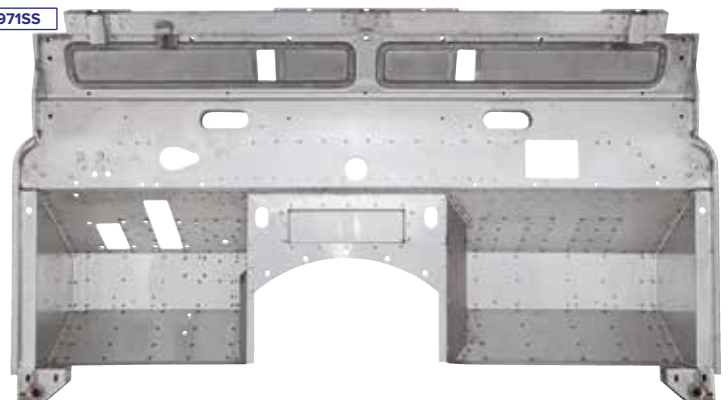

**Bulkheads**  
Defender - 300Tdi & Td5  
**DA2970SS NEW** Right hand drive  
**DA2971SS NEW** Left hand drive

### Stainless Steel Products

#### Direct Replacement Mudflap Brackets

Defender 90/110/130

<b>MTC3000SS</b>	Front	RHS
<b>MTC3001SS</b>	Front	LHS
Defender 90		
<b>MUC3986SS</b>	Rear	RHS
<b>MUC3987SS</b>	Rear	LHS
Defender 110/130		
<b>CAT500340PMASS*</b>	Rear	RHS
<b>CAT500350PMASS*</b>	Rear	LHS

\*Brackets can also be used with CAT500360PMA & CAT500370PMA as replacement brackets. These brackets are not available as stand alone brackets - they are only available to order along with the mudflap. The universal number for all Defender 110/130 rear applications is BTR277.



**DA8200**  
Anti-luce Pin Kit



**DA1935**  
**2nd Row Seat Belt Floor Mounting**  
Defender - CSW/Series - SW  
Pair. Made from stainless steel 304 grade 2mm thick and are laser cut. Fixings are included -  
4 x M12 A4-80 x 20mm hex head bolts  
4 x M12 A4 flat washers & 4 x Rivets

**Note** - A4-80 is the equivalent of mild steel 8.8 high tensile bolts



**DA4871** Mirror finish  
**DA4871B** Brushed finish

#### A-post Trims

Defender

The A-Post Trims are designed to replace the existing trim and will cover the corner where they normally tear. The door threshers are made from stainless steel 304 grade bright annealed 1.5mm thick and are laser cut and CNC pressed. Includes fixings. Pair.



#### MTC6332BRKT NEW

#### Radiator Grille Bracket

Defender - 1987 - 2016  
With air-con -Stainless steel  
Single



#### MTC6332KIT

#### Radiator Grille Bracket Kit

Defender

Stainless steel mounting bracket with air-con front panel brackets. Machine cut and CNC pressed for accuracy. Ready to bolt in place.  
4 x No8 x 16mm A2 Pz2 screws  
2 x A4-70 No14 x 25mm Pz3 stainless steel screws

4 x M5 A4 flat washers  
2 x M6 A4 flat washers  
2 x M8 A4-80 x 20mm hex head bolts  
2 x M8 A4 flat washers  
4 x No6 plastic lock nuts  
2 x No14 captive U nuts  
2 x M8 A2/304 captive nuts

**Note** - A4-80 is the equivalent of mild steel 8.8 high tensile bolts



Photo by Corlius Jooste



### Defender

#### Bodywork - Bulkhead

DA40650	90/110	Bulkhead upper repair panel	RHS
DA4065N	90/110	Bulkhead upper repair panel	LHS
DA45970	90/110	Bulkhead repair panel with vents	RHS
DA4597N	90/110	Bulkhead repair panel with vents	LHS
DA20260	90/110	Door pillar repair - bulkhead/bracket	RHS
DA2026N	90/110	Door pillar repair - bulkhead/bracket	LHS
DA4054	90/110	Bracket for DA2026N/DA2026O - pair	RHS/LHS
DA6101	90/110	Footwell - right hand drive	RHS
DA6100	90/110	Footwell - right hand drive	LHS
DA6103	90/110	Footwell - left hand drive	RHS
DA6102	90/110	Footwell - left hand drive	LHS
DA4680	90/110	Extended bulkhead upper repair panels	Pair
DA4931 NEW	90/110	Inner wing bracket	RHS
DA4930 NEW	90/110	Inner wing bracket	LHS

#### Bodywork - Doors

ALR6852	90/110	Rear door - less spare wheel carrier - from MA939976 up to 1A622423	
LR075816	90/110	Rear door - 1 piece	
CQB000140	90/110	Glass for BIC710250	
LR042728	90/110	Heated glass for BIC710250	
CVW500010	90/110	Glazing rubber for BIC710250	
DA4054	90/110	Bracket for DA2026N/DA2026O - pair	RHS/LHS
DA2024	90/110	Safari rear door skin bottom half - up to 2006	
DA4143	90/110	Front door skin - push button handle	RHS
DA4144	90/110	Front door skin - push button handle	LHS
STC542	90/110	Front door assembly - lift handle	RHS
STC543	90/110	Front door assembly - lift handle	LHS
LR029310	90/110	Front door assembly - push button handle	RHS
LR029311	90/110	Front door assembly - push button handle	LHS
LR027545	110/130	2nd row door assembly - push button handle	RHS
LR027546	110/130	2nd row door assembly - push button handle	LHS
DA5130	110/130	2nd row door skins - up to 5A689036	RHS
DA5131	110/130	2nd row door skins - up to 5A689036	LHS
DA4142	110/130	2nd row door skins - up to 5A689036 - steel	LHS
RTC6247	90/110	Safari rear door - unglazed with spare wheel	
RTC6248NG	90/110	Safari rear door - unglazed without spare wheel	
DA3613	90/110	Safari rear door - goal post cladding	
STC1424	90/110	Rear door - less spare wheel carrier - from AA242000 up to KA929577	
DA4086	90/110	Rear door bottom repair section	
DA6104	90/110	Front door bottom repair section	
ALR9804	130	Rear quarter panel	RHS
ALR9803	130	Rear quarter panel	LHS
DA1355	90/110	Repair section for under the window - see web for more	
DA1722	110	Door rubber seal holders - front & 2nd row	
DA6645	90/110	Front door bottom repair assembly - up to 2006	RHS
DA6646	90/110	Front door bottom repair assembly - up to 2006	LHS
DA6655	110/130	2nd row door bottom repair assembly	RHS
DA6654	110/130	2nd row door bottom repair assembly	LHS

#### Bodywork - Footwells/Floor

ALR1742	90/110	Floor panel - front - Tdi/Td5/V8	RHS
ALR1743	90/110	Floor panel - front - Tdi/Td5/V8	LHS
AFC710010	90/110	Rear tub floor reinforcement crossmember	
AFC710010GALV	90/110	Rear tub floor reinforcement crossmember	Galvanised

#### Bodywork - General

Full side frame assembly, supplied in 3 pieces. Ready to weld in place. These are made to suit the push on door seals, if you have rivet on door seals, you will have to alter the door seals to suit.

DA4780		Full side frame assembly - 4/5 door	RHS
DA4787		Full side frame assembly - 4/5 door	LHS
'C' Post repair sections are 1.2mm thick zintec coated mild steel. Machine cut and CNC pressed for accuracy. Ready to weld in place.			
DA4786		Full 'C' post - 4/5 door	RHS
DA4785		Full 'C' post - 4/5 door	LHS
DA1354		'C' post bottom leg - 4/5 door	RHS
DA1353		'C' post bottom leg - 4/5 door	LHS
RTC6283	90	Bodyside panel	RHS
RTC6284G	90	Bodyside panel	LHS
STC1854G		Rear end panel	RHS
STC1855G		Rear end panel	LHS
DA1393		Battery box Right hand drive	

Manufactured from 2mm thick aluminium, CNC pressed and laser cut for accuracy. The battery box is supplied in 4 pieces for ease of fitting, pre-drilled to aid fitting and supplied with 50 x A type rivets.

DA4782	110	B-Post for vehicles with second row doors	
ASJ710060	7A000001 onwards	Front radiator grille frame with air-con	
ALA710680G NEW	110	Lower rear body side panel	RHS
DA5250		Rear wing to wheel arch stiffener - 2mm thick aluminium	Pair
DA2752		2nd row seat conversion kit	

An ideal kit to install 2007 Puma seats into your pre-2007 Defender. Kit comprises of - 1 x Mid-crossmember; 2 x 2nd row seat supports; 2 x 2nd row seat chassis bracket fixing kits; 2 x Front wheel arch panels

DA2751		Front wheel arch panels	Pair
Defender 110 and 130 (4 or 5 door) - 2007 onwards. For replacing front of rear wheel arch panel. Also ideal if you want to fit Puma seats in the 2nd row of your 110. Made from 2mm thick aluminium and also CNC cut and bent for accuracy.			

BKA710140 NEW	90/110	Bonnet assembly - 2007 - 2016	
---------------	--------	-------------------------------	--



#### Bodywork - Seats

DA4682	90/110	Seat box end panel	RHS
DA4681	90/110	Seat box end panel	LHS
DA1936		Defender - up to and including 200Tdi	
Aluminium seat box frame for LT77. Supplied in pieces, takes 5-10 minutes to assemble with fixings included. 2 x seat box end; 2 x middle seat box panel with rivnuts for seat base; 2 x seat box end panel; 1 x seat box back angle with rivnuts for seat base; 1 x front panel & 100 x type B rivets			

#### Bodywork - Windows

DA4032	90/110	Window kit - standard	Pair	Clear
DA4032GREY	90/110	Window kit - standard	Pair	Grey tinted
DA4033	90/110	Window kit - deluxe	Pair	Clear
DA4033GREEN	90/110	Window kit - deluxe	Pair	Green tinted
DA4033GREY	90/110	Window kit - deluxe	Pair	Grey tinted
DA4033BRONZE	90/110	Window kit - deluxe	Pair	Bronze tinted
DA4033CATCH		Replacement catch for deluxe window kit	Single	
DA4032-3SEAL		Replacement window seal for above part numbers. One seal per kit.		

#### Bodywork - Sills

DA1721	110	Sill rails - brackets included	RHS
DA1720	110	Sill rails - brackets included	LHS

#### Bodywork - Wings

ALR6122G	90/110	Front outer wing panel	RHS
ALR6678G NEW	90/110	Front outer wing panel	RHS
ALR6677G	90/110	Front outer wing panel	LHS
RTC6352G	90/110	Front outer wing panel	LHS
RTC6353	90/110	Front nose panel	RHS
RTC6354	90/110	Front nose panel	LHS
ALR5990	90/110	Front nose panel	RHS
ALR5989LR	90/110	Front nose panel	LHS
ALR9935	90/110	Inner wing assembly	LHS
DA5250		Rear wing to wheel arch stiffener - 2mm thick aluminium	Pair

#### ABS Plastic Front Outer Wing Panels

DA2397	90/110	Replacement for ALR6678, ASB710280 & RTC6351	RHS
DA2399	90/110	Replacement for ALR6122 & ASB710260	RHS
DA2396	90/110	Replacement for RTC6352, ALR6677 & ASB710290	LHS
DA2398	90/110	Replacement for RTC6350, ALR6121 & ASB710270	LHS

For many more body & chassis product pictures go to [www.britpart.com/chassis](http://www.britpart.com/chassis)



**Defender**

**Chassis - Axle**

<b>STC8604</b>	90/110	Front radius arm mount	RHS
<b>STC8605</b>	90/110	Front radius arm mount	LHS
<b>STC8606</b>	90/110	Rear radius arm mount	RHS
<b>STC8607</b>	90/110	Rear radius arm mount	LHS

**Chassis - Bulkhead**

<b>STC8354</b>	90/110	Bulkhead outrigger	RHS
<b>STC8355</b>	90/110	Bulkhead outrigger	LHS
<b>STC8695</b>	90/110	Tie bracket from bulkhead rigger	RHS
<b>STC8694</b>	90/110	Tie bracket from bulkhead rigger	LHS

**Chassis - Crossmembers**

<b>ANR2056</b>	90/110	Rear crossmember no extensions - pre-Td5
<b>DA4019</b>	90*	Rear crossmember plus extensions - pre-Td5
<b>DA4020</b>	110*	Rear crossmember plus extensions - pre-Td5
<b>DA4373</b>	90*	Rear crossmember plus extensions - Td5 & TDCi
<b>DA4374</b>	110*	Rear crossmember plus extensions - Td5 & TDCi
*With long extensions and body brackets - see website for pictures		
<b>DA4373S</b>	90	Rear crossmember with short extensions - Td5 & TDCi
<b>DA4374S</b>	110	Rear crossmember with short extensions - Td5 & TDCi
<b>KVB500060</b>	90/110	Bolt on crossmember
<b>DA5300</b>	90/110	Bolt on crossmember - galvanised with fittings
<b>KVB500230</b>	110	Crossmember assembly - 2nd row seats
		Defender - 2007 onwards - crew cab
<b>KVB000290</b>	90/110	Rear crossmember no extensions - 2A627496 onwards
<b>NRC4171GALV</b>	110	Station wagon & crew cab galvanised bolt-on centre crossmember
<b>ANR3713G</b>	90/110	300Tdi gearbox crossmember - galvanised

**Chassis - General**

<b>DA4516</b>	90/110	Rear tie bar mounting bracket - single	
<b>STC8356</b>	110	Rear outrigger	RHS/LHS
<b>STC8648</b>	90	Rear tubular outrigger	RHS
<b>STC8649</b>	90	Rear tubular outrigger	LHS
<b>STC8652</b>	90/110	Front chassis leg	RHS
<b>STC8653</b>	90/110	Front chassis leg	LHS
<b>DA1830</b>	90/110	Universal chassis to seatbelt bracket - galvanised	
<b>DA6648</b>	90	Half chassis - 200Tdi & 300Tdi - not galvanised	
<b>DA6669</b>	110	Half chassis - 200Tdi & 300Tdi - not galvanised	
<b>DA6668</b>	90	Half chassis - Td5 - not galvanised	
<b>DA6670</b>	110	Half chassis - Td5 - not galvanised	

For many more body & chassis product pictures go to [www.britpart.com/chassis](http://www.britpart.com/chassis)

**Chassis - Suspension Mounts**

<b>DA4509</b>	90/110	Front axle spring mount - 40mm lift	RHS
<b>DA4508</b>	90/110	Front axle spring mount - 40mm lift	LHS
<b>DA4514</b>	90/110	Front axle spring mount - standard	RHS
<b>DA4513</b>	90/110	Front axle spring mount - standard	LHS
<b>DA4515</b>	90/110	Rear shock absorber bracket - pair	
<b>DA4518</b>	90/110	Rear axle spring mount - 40mm lift	
<b>DA4527</b>	90/110	Rear axle spring mount - standard	
<b>STC8693</b>	90/110	Front spring seat	RHS
<b>STC8608</b>	90/110	Front spring seat	LHS
<b>STC8610</b>	90	Rear spring seat	RHS/LHS
<b>STC8609</b>	110	Rear spring seat	RHS/LHS
<b>DA1330 NEW</b>	90/110	Bumpstop - axle	
<b>DA6701 NEW</b>	90/110	Bumpstop - chassis	

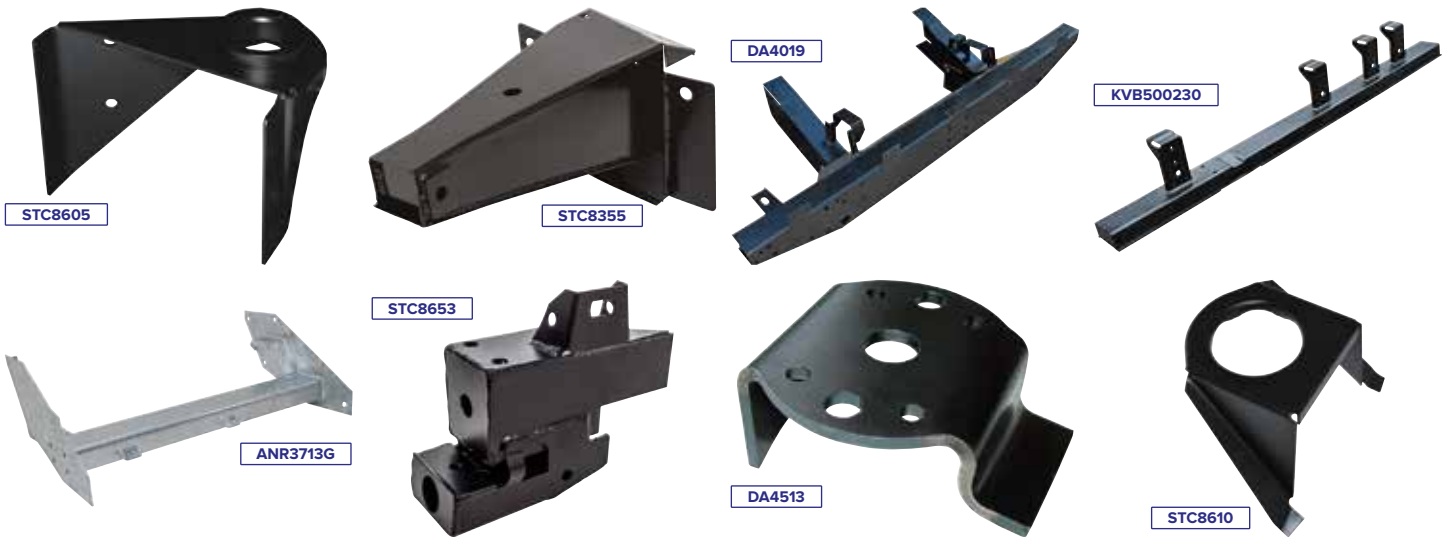

**Universal Replacement Bulkhead**

**DA2970 NEW**  
Defender - 1983 - 2006  
Right hand drive  
Loose brackets are included in the kit to allow for model year differences made by Land Rover over the years. Some minor modifications to the transmission tunnel may be needed to accommodate different transmission tunnels, with the V8 for example.  
Made in the West Midlands just like a Land Rover.







**Discovery 2**



**DA8902O**

Rear chassis leg  
**DA8902O** Right hand side  
**DA8902N** Left hand side



**DA4742**

Top rear shock absorber mount assembly  
**DA4742** Right hand side  
**DA4741** Left hand side



**DA2544O**

Rear body mount bracket  
**DA2544O** Right hand side  
**DA2544N** Left hand side



**DA2543N**

Rear bumper mount brackets  
**DA2543O** Right hand side  
**DA2543N** Left hand side



**DA2670**

Front outriggers  
**DA2670** Right hand side  
**DA2669** Left hand side



**DA2668**

Rear outriggers  
**DA2668** Right hand side  
**DA2667** Left hand side



**DA2565**  
Rear half chassis



**DA8903**  
Rear quarter chassis



**DA2545**  
Rear spring mount bracket



Photo by Jon Wilson

**Series 1**

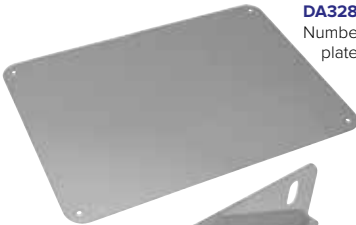

**DA3283**  
Number plate backing plate - 1948 - 1953

**DA3274**



Rear body tub bracket - 1948 - 1953  
**DA3273** Right hand side  
**DA3274** Left hand side



**DA3275**

Door bottom - 1948 - 1951  
**DA3275** Right hand side  
**DA3276** Left hand side



**DA3278**

Front side wing outer panel with hole for buffer 80" - 1948 - 1951  
**DA3277** Right hand side  
**DA3278** Left hand side

**CKD SHOP**



**DA3279**

Cover plate for wing valance - 1948 - 1953  
**DA3279** Right hand side  
**DA3280** Left hand side

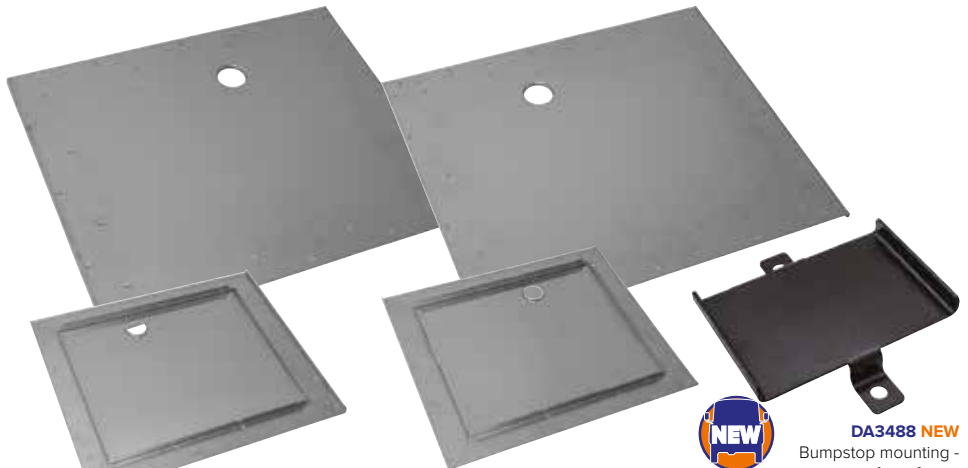

**DA3281**  
Petrol tank lid - 1948 - 1953

**DA3282**  
Tool locker lid - 1948 - 1953 - No map pocket



**DA3488 NEW**  
Bumpstop mounting - front & rear



# CHASSIS & BODY

## Chassis & Body Components

### Series 2 & 3

#### Bodywork - Bulkhead

##### DA4678

Series 3 - universal. Accepts early type door seals. Manufactured with zinc coated steel. Etched primed and sealed. All UNF fittings. Cut outs and strengtheners in both footwells to accommodate LHD and RHD. Weld on gearbox cover. No hand throttle holes.

DA40650	SWB/LWB	Bulkhead upper repair panel	RHS
DA4065N	SWB/LWB	Bulkhead upper repair panel	LHS
DA45970	SWB/LWB	Bulkhead repair panel with vents	RHS
DA4597N	SWB/LWB	Bulkhead repair panel with vents	LHS
DA20260	SWB/LWB	Door pillar repair - bulkhead/bracket	RHS
DA2026N	SWB/LWB	Door pillar repair - bulkhead/bracket	LHS
DA4054	SWB/LWB	Bracket for DA2026N/DA20260 - pair	RHS/LHS
DA4680	SWB/LWB	Extended bulkhead upper repair panels	Pair

#### Bodywork - Doors

306460	SWB/LWB	Interior handle	
337791	SWB/LWB	Door bottom	Series 2 & 2A RHS
337792	SWB/LWB	Door bottom	Series 2 & 2A LHS
395529	SWB/LWB	Door bottom	Series 2, 2A & 3 RHS
DA27700	SWB/LWB	Door skin for 395530	Series 2, 2A & 3 RHS
395530	SWB/LWB	Door bottom	Series 2, 2A & 3 LHS
DA2770N	SWB/LWB	Door skin for 395529	Series 2, 2A & 3 RHS
ALR6262 NEW	SWB/LWB	Door bottom	Series 2A, 3 & One Ten RHS
ALR6263 NEW	SWB/LWB	Door bottom	Series 2A, 3 & One Ten LHS
DA2007	SWB/LWB	Door rubber	30m roll
RTC6247	SWB/LWB	Safari rear door - unglazed with spare wheel	
RTC6248NG	SWB/LWB	Safari rear door - unglazed without spare wheel	
DA3613	SWB/LWB	Safari rear door - goal post cladding	
DA20230	SWB/LWB	Door skin	RHS
DA2023N	SWB/LWB	Door skin	LHS
MTC5382	SWB/LWB	Door top - unglazed	RHS
MTC5383	SWB/LWB	Door top - unglazed	LHS
MTC5382G	SWB/LWB	Door top - glazed	RHS
MTC5383G	SWB/LWB	Door top - glazed	LHS
DA4086	SWB/LWB	Rear & side door bottom repair section	
DA2156	SWB/LWB	Glazing kit - door top	Series 3
DA1722	LWB	Door rubber seal holders - front & 2nd row	

#### Bodywork - Footwells/Floor

DA20010	SWB/LWB	Footwell	RHD	RHS
DA2001N	SWB/LWB	Footwell	RHD	LHS

Made from 1.2mm thick zinc coated mild steel and are also machine cut and CNC pressed for accuracy. Include the strengthening ribs as per originals.

DA4869	SWB/LWB	Footwell - includes ribs	RHD	RHS
DA4868	SWB/LWB	Footwell - includes ribs	RHD	LHS
DA4869LHD	SWB/LWB	Footwell - includes ribs	LHD	RHS
DA4868LHD	SWB/LWB	Footwell - includes ribs	LHD	LHS
DA4018N	SWB/LWB	Footwell	LHD	RHS
DA4018O	SWB/LWB	Footwell	LHD	LHS
330037	SWB/LWB	Front footplate		RHS
330038	SWB/LWB	Front footplate		LHS
AFC710010	SWB/LWB	Rear tub reinforcement crossmember		
AFC710010GALV	SWB/LWB	Rear tub reinforcement crossmember		Galvanised

#### Bodywork - General

DA6110	Series 1/Series 2/Series 2A	Headlight surround - chrome	
330950	Series 2/2A - up to suffix A	Radiator panel	
336466	Series 2A - suffix B to suffix F	Radiator panel	
347955	Series 3	Radiator panel	

Full side frame assembly, supplied in 3 pieces. Ready to weld in place. These are made to suit the push on door seals, if you have rivet on door seals, you will have to alter the door seals to suit.

DA4780	Full side frame assembly - 4/5 door	RHS
DA4787	Full side frame assembly - 4/5 door	LHS

'C' Post repair sections are 1.2mm thick zinc coated mild steel.

Machine cut and CNC pressed for accuracy. Ready to weld in place.

DA4786	Full 'C' post - 4/5 door	RHS
DA4785	Full 'C' post - 4/5 door	LHS
DA4782	LWB	B-Post for vehicles with second row doors
DA1354	'C' post bottom leg - 4/5 door	RHS
DA1353	'C' post bottom leg - 4/5 door	LHS
DA2750	Series 2 & Series 3	Bonnet frame top hat supports

Top hat supports for the underside of the bonnet. 1.2mm thick zinc coated mild steel and machine cut and CNC pressed for accuracy.

#### Bodywork - Seats

DA4682	SWB/LWB	Seat box end panel	RHS
DA4681	SWB/LWB	Seat box end panel	LHS

#### Bodywork - Sills

330326	SWB	Front sill panel - 5"	RHS
330327	SWB	Front sill panel - 5"	LHS
330336	SWB	Rear sill panel - 5"	RHS
330337	SWB	Rear sill panel - 5"	LHS
DA1721	LWB	Sill rails - brackets included	RHS
DA1720	LWB	Sill rails - brackets included	LHS

#### Bodywork - Wings & Nose

##### Aluminium front outer wing panels

330426	Series 2 & 2A - right & left hand drive	RHS with no hole
330427	Series 2 & 2A - right & left hand drive	LHS with no hole
347474	Series 3 - left hand drive	RHS with hole
347475	Series 3 - right hand drive	LHS with hole
346936 NEW	Series 3	Wing trim heater air intake

##### ABS plastic front outer wing panels

DA2463	Series 2 & 2A - right & left hand drive	RHS with no hole	
	Series 3 - right hand drive		
DA2462	Series 2 & 2A - right & left hand drive	LHS with no hole	
	Series 3 - left hand drive		
DA2464	Series 3 - right hand drive	LHS with hole	
DA2465	Series 3 - left hand drive	RHS with hole	
346936 NEW	Series 3	Wing trim heater air intake	
DA2521	Series 3	Nose panel	RHS
DA2520	Series 3	Nose panel	LHS

#### Bodywork - Windows

DA2002	SWB/LWB	Window channel	2m length	
DA4032	SWB/LWB	Window kit - standard	Pair	Clear
DA4032GREY	SWB/LWB	Window kit - standard	Pair	Grey tinted
DA4033	SWB/LWB	Window kit - deluxe	Pair	Clear
DA4033GREEN	SWB/LWB	Window kit - deluxe	Pair	Green tinted
DA4033GREY	SWB/LWB	Window kit - deluxe	Pair	Grey tinted
DA4033BRONZE	SWB/LWB	Window kit - deluxe	Pair	Bronze tinted
DA4033CATCH	Replacement catch for deluxe window kit			Single
DA4032-3SEAL	Replacement window seal for above part numbers. One seal per kit.			

#### Chassis - Crossmembers

218453	SWB	Gearbox crossmember - weld on
592592 NEW	LWB	Gearbox crossmember - weld on
559822	Military	Rear crossmember
DA4017	SWB	Rear crossmember / ¼ chassis with extensions and hangers
NRC236	SWB/LWB	Rear crossmember - no extensions
NRC236E	SWB/LWB	Rear crossmember - with extensions, no hangers

#### Chassis - General

DA20080	SWB/LWB	Chassis leg - front	RHS
DA2008N	SWB/LWB	Chassis leg - front	LHS
DA2009	SWB/LWB	Extension piece (2 x 'U' shape sections) for rear crossmember	

DA2014	SWB/LWB	Bulkhead outrigger	
DA2015O	SWB	Rear tank outrigger	RHS
DA2015N	SWB	Rear tank outrigger	LHS
DA2017O	LWB	Rear tank outrigger	RHS
DA2017N	LWB	Rear tank outrigger	LHS
DA2019O	SWB	Front tank outrigger	RHS
DA2019N	SWB	Front tank outrigger	LHS
DA2099	SWB	½ chassis	

#### Chassis - Suspension Mounts

DA3488 NEW	Series 1, 2, 2A & 3	Bumpstop mounting - front & rear
DA2013	SWB	Spring hanger
DA2016	LWB	Spring hanger - front
DA2116	LWB	Spring hanger - rear

For many more body & chassis product pictures go to [www.britpart.com/chassis](http://www.britpart.com/chassis)



### Range Rover Classic

#### Bodywork - Doors

<b>MXC2064</b>	Door outer skin - front	4-door	RHS
<b>MXC2063</b>	Door outer skin - front	4-door	LHS

#### Bodywork - General

<b>DA40130</b>	Rear arch extension		RHS
<b>DA4013N</b>	Rear arch extension		LHS
<b>RTC6317</b>	Headlight box		RHS
<b>RTC6318</b>	Headlight box		LHS
<b>DA40080</b>	Battery carrier		RHS
<b>DA4008N</b>	Battery carrier		LHS
<b>DA6367</b>	Rear quarter window seal	4-door	Pair
<b>DA6437</b>	Front quarter window seal	2-door	Pair
<b>390055</b>	Rear quarter panel fixing plate		Single
<b>391127</b>	Rear side window channel		Single
<b>391141</b>	Front wing seal		Single
<b>391546</b>	Side window gasket		Single
<b>392222</b>	Anti-rattle pad		Single
<b>392223</b>	Anti-rattle pad		Single
<b>AEU1523</b>	Rear light gasket		Single
<b>AEU1525</b>	Rear light gasket		Single
<b>MRC7166</b>	Lock & handle gasket		Single
<b>MXC8335</b>	Check strap seal		Single
<b>PRC2949</b>	Bonnet light rubber		Single
<b>RTC4517CL</b>	Glazed tailgate	1986 - 1991	Single
<b>MXC6828</b>	Front bumper spoiler	1991 - 1994	Single

#### Bodywork - Sills

<b>390381</b>	Complete sill - outer, no mounts	2-door	RHS
<b>390382</b>	Complete sill - outer, no mounts	2-door	LHS
<b>DA3016</b>	Outer sills	2-door	RHS
<b>DA3017</b>	Outer sills	2-door	LHS
<b>DA41200</b>	Half sill (repair) - outer	4-door	RHS
<b>DA4120N</b>	Half sill (repair) - outer	4-door	LHS
<b>MXC3918</b>	Sill inner	2-door	RHS
<b>MXC3919</b>	Sill inner	2-door	LHS
<b>STC1136</b>	Outer sills	4-door	RHS
<b>STC1135</b>	Outer sills	4-door	LHS

#### Bodywork - Wings

<b>DA40070</b>	Inner wing		RHS
<b>DA4007N</b>	Inner wing		LHS
<b>DA40160</b>	Rear inner wing - floor section	2-door	RHS
<b>DA4016N</b>	Rear inner wing - floor section	2-door	LHS
<b>DA40150</b>	Rear inner wing - side panel	2-door	RHS
<b>DA4015N</b>	Rear inner wing - side panel	2-door	LHS

#### ABS plastic front outer wing panels

<b>DA2468</b>	Replacement for STC729 - up to 1988		RHS
<b>DA2467</b>	Replacement for STC730 - up to 1988		LHS
<b>DA2469</b>	Replacement for MXC1408 - 1989 onwards		RHS
<b>DA2470</b>	Replacement for MXC1409 - 1989 onwards		LHS



#### Chassis - Crossmembers

<b>ALR8520</b>	Rear crossmember - 1990 onwards
<b>NRC4717</b>	Tailgate crossmember - rear

#### Chassis - General

<b>DA4516</b>	Rear tie bar mounting bracket	Single
<b>DA4556</b>	Body mount kit	

#### Chassis - Suspension Mounts

<b>DA4509</b>	Front axle spring mount - 40mm lift	RHS
<b>DA4508</b>	Front axle spring mount - 40mm lift	LHS
<b>DA4514</b>	Front axle spring mount - standard	RHS
<b>DA4513</b>	Front axle spring mount - standard	LHS
<b>DA4515</b>	Rear shock absorber bracket	Pair
<b>DA4518</b>	Rear axle spring mount - 40mm lift	
<b>DA4527</b>	Rear axle spring mount - standard	
<b>DA1330 NEW</b>	Bumpstop - axle	
<b>DA6701 NEW</b>	Bumpstop - chassis	

For many more body & chassis product pictures go to [www.britpart.com/chassis](http://www.britpart.com/chassis)

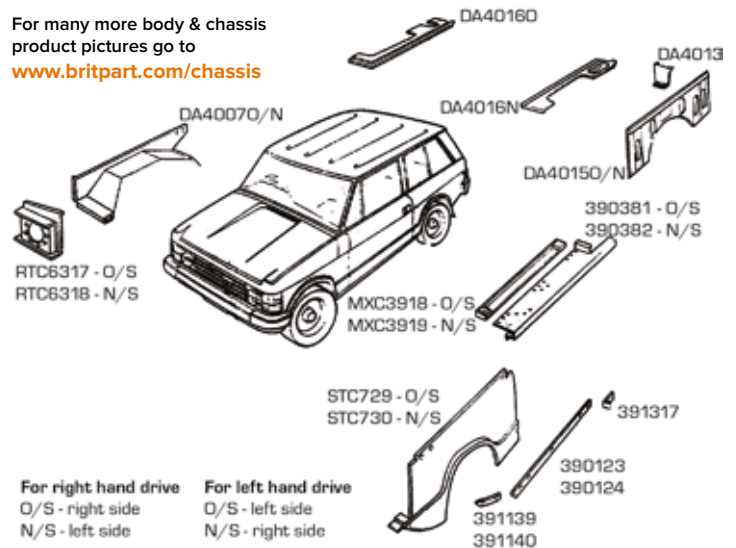

For right hand drive O/S - right side N/S - left side  
For left hand drive O/S - left side N/S - right side





# CHASSIS & BODY

## Chassis & Body Components

### Discovery 3 & Discovery 4



**DPB500075LML**

Bumper  
Primed  
With headlight power wash & front parking aid



Discovery 3 & 4  
Sill Repair Panels  
**DA1941**  
Right hand side  
**DA1942**  
Left hand side

### Freelander 1 & Freelander 2



**ALR8710**  
Freelander 1  
Bulkhead front assembly



**LR006253LR**  
Freelander 2  
Bumper. Primed with headlight power wash, front parking aid & front fog lights.



Photo by Kevin Masson

### Series Door Seal Kits



#### Front Door Seal Kit - Right hand side

**DA1494**

MRC5740	Sealing rubber	1
395598	Sealing rubber	1
395670	Sealing rubber	1
395672	Sealing rubber	1
395673	Sealing rubber	1
395674	Sealing rubber	1
78248	Pop rivet - 35mm	50

#### Front Door Seal Kit - Left hand side

**DA1495**

MRC5741	Sealing rubber	1
395599	Sealing rubber	1
395671	Sealing rubber	1
395672	Sealing rubber	1
395673	Sealing rubber	1
395674	Sealing rubber	1
78248	Pop rivet - 35mm	50

#### 2nd Row Door Seal Kit - Right hand side

**DA1496**

MRC9397	Sealing rubber	1
395674	Sealing rubber	3
333261	Sealing rubber	1
333233	Sealing rubber	1
395670	Sealing rubber	1
78248	Pop rivet - 35mm	50

#### 2nd Row Door Seal Kit - Left hand side

**DA1497**

MRC9397	Sealing rubber	1
395674	Sealing rubber	3
333262	Sealing rubber	1
333233	Sealing rubber	1
395671	Sealing rubber	1
78248	Pop rivet - 35mm	50

**DA1494G**  
*Kits with OEM seals & rivets*

MRC5740G	Sealing rubber	1
395598G	Sealing rubber	1
395670G	Sealing rubber	1
395672G	Sealing rubber	1
395673G	Sealing rubber	1
395674G	Sealing rubber	1
78248G	Sealed pop rivet	50

**DA1495G**  
*Kits with OEM seals & rivets*

MRC5741G	Sealing rubber	1
395599G	Sealing rubber	1
395671G	Sealing rubber	1
395672G	Sealing rubber	1
395673G	Sealing rubber	1
395674G	Sealing rubber	1
78248G	Sealed pop rivet	50

**DA1496G**  
*Kits with OEM seals & rivets*

MRC9397G	Sealing rubber	1
395674G	Sealing rubber	3
333261	Sealing rubber	1
333233G	Sealing rubber	1
395670G	Sealing rubber	1
78248G	Sealed pop rivet	50

**DA1497G**  
*Kits with OEM seals & rivets*

MRC9397G	Sealing rubber	1
395674G	Sealing rubber	3
333262	Sealing rubber	1
333233G	Sealing rubber	1
395671G	Sealing rubber	1
78248G	Sealed pop rivet	50

**DA1499**

337290	Tailboard seal	2
303975	Door seal	1
332146	Tailboard buffer	4
SE104121L	Screw	4
NH104041L	Nut	4
WA104001L	Washer - plain	4

**Tailgate Seal Kit**  
**DA1499**

337290	Tailboard seal	2
303975G	Door seal	1
332146	Tailboard buffer	4
SE104121L	Screw	4
NH104041L	Nut	4
WA104001L	Washer - plain	4

**DA1499G**  
*Kits with OEM seals & rivets*

337290G	Tailboard seal	2
303975G	Door seal	1
332146	Tailboard buffer	4
SE104121L	Screw	4
NH104041L	Nut	4
WA104001L	Washer - plain	4

**DA1498G**

396113	Safari door rubber	1
395674	Sealing rubber	3
332563	Door seal	1
332564	Sealing rubber	1
78248	Sealed pop rivet	50

**Safari Rear Door Seal Kit**  
**DA1498**

396113	Safari door rubber	1
395674	Sealing rubber	3
332563	Door seal	1
332564	Sealing rubber	1
78248	Sealed pop rivet	50

**DA1498G**  
*Kits with OEM seals & rivets*

396113	Safari door rubber	1
395674G	Sealing rubber	3
332563G	Door seal	1
332564G	Sealing rubber	1
78248G	Sealed pop rivet	50

All kits are suitable for all Series vehicles.

The G part number kits have OEM seals and rivets.

### Quick Release Handle Kit



**DA1800**  
Defender 90 & 110  
Soft top windscreen quick release handle fixing kit.

### Catch Assembly



Defender  
Rear sliding window catch assembly  
**DA1901** Right hand side  
**DA1902** Left hand side

### Door Lock Button Kit



**DA2499**  
Defender  
3 piece door lock button kit  
Black

### Locking Door Catch Buttons



Series 1 - 1954 onwards, 2, 2A & 3  
**345435G** Right hand side  
**345436G** Left hand side

**Door Hinge Kits**



**Stainless Steel Finish Kits** - Marine grade 316 stainless steel, polished & supplied with stainless steel fitting kit

- DA1951** Defender/Series 3  
Front row doors - set of 4
- DA1952** Defender/Series 3  
2nd row doors - set of 4
- DA1392** Defender/Series 2/3  
Rear door kit

**Natural Aluminium Finish Kits** - Supplied with stainless steel fitting kit

- DA1131** Defender/Series 3  
Front row doors - set of 4
- DA1309** Defender/Series 3  
2nd row doors - set of 4

**DA1131KIT** Replacement stainless steel bolts, inserts & washers for DA1131 & DA1309

**Anodised Black Finish Kits** - Supplied with stainless steel fitting kit

- DA1305** Defender/Series 3  
Front row doors - set of 4
- DA1306** Defender/Series 3  
2nd row doors - set of 4

**DA1131KIT** Replacement stainless steel bolts, inserts & washers for DA1305 & DA1306



**Zinc Plated Steel Kits**

- DA1070** Defender/Series 3  
Defender - 2007 onwards but can be used on earlier vehicles  
Front door hinge kit with torx head bolts and all other fixings.
- DA1070SS** Defender/Series 3  
Defender - 2007 onwards but can be used on earlier vehicles  
Front door hinge kit with stainless steel torx head bolts and all other fixings
- DA1275** Defender/Series 3  
Defender - 2007 onwards but can be used on earlier vehicles  
2nd row door hinge kit with torx head bolts and all other fixings
- DA1275SS** Defender/Series 3  
Defender - 2007 onwards but can be used on earlier vehicles  
2nd row door hinge kit with stainless steel torx head bolts and all other fixings
- DA1240** Defender/Series 2/3  
Rear door hinge kit. Supplied with stainless steel fitting kit
- DA1240SS** Defender/Series 2/3  
Defender - 2007 onwards but can be used on earlier vehicles  
Rear door hinge kit. Supplied with stainless steel torx head.
- DA1145** Stainless steel hinge pin upgrade for DA1240 & DA1240SS

*All Hinge Kits Supplied With Fitting Kits*

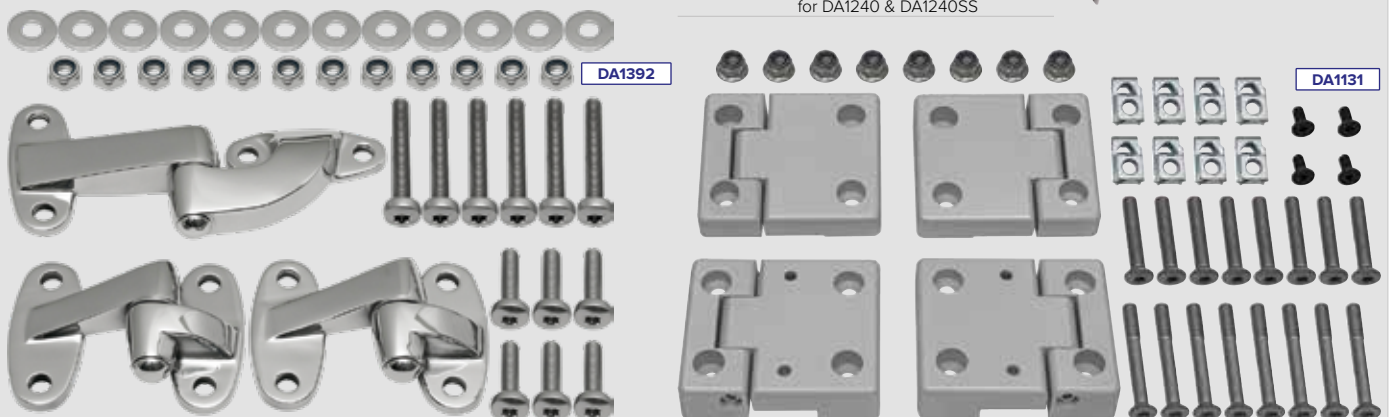



# CHASSIS & BODY

## Chassis & Body Components

### Fuel Tank Fitting Kit



**DA2542**  
Fitting kit to fit Series SWB  
Fuel tank - 552174

### Fuel Latch Repair Kit



**DA1114**  
Discovery 3/Discovery 4/Range Rover Sport - 2015 - 2013  
This handy little OEM kit is used to repair the temperamental fuel latch.



### Bonnet Insulation Pad



**MTC4503**  
Range Rover Classic

### Door Lock Kits



Defender replacement front door lock kits  
Defender - 2007 onwards  
**FQJ500240KIT** RHS  
**FQJ500250KIT** LHS



Defender replacement rear door lock kits  
Defender - 2007 onwards  
**FQM100761KIT** RHS  
**FQM100771KIT** LHS

### Tailgate Half Door Kit



**DA6520**  
Defender  
Converts a vehicle with a drop down tailgate to a side opening half door. Ideal for pick-ups and soft-tops.

### Tailgate Hinge Brackets



**DA2498**  
Series/Defender

### Window Kits



**Standard**  
Defender & Series  
Standard kits have a metal catch.  
Glass is toughened to E11 CE R - 43.  
**DA4032** Clear Pair  
**DA4032GREY** Grey tinted Pair

**Deluxe**  
Defender & Series  
Deluxe kits have rubber mounting strips to cover rivets and a plastic catch. Glass is toughened to E11 CE R - 43.  
**DA4033** Clear Pair  
**DA4033GREEN** Green tinted Pair  
**DA4033GREY** Grey tinted Pair  
**DA4033BRONZE** Bronze tinted Pair

**DA4032-3SEAL**  
Replacement window seal for both standard and deluxe windows. Each kit does one window.



**DA4033CATCH**  
Replacement catch for deluxe window kit. Single.



### Door Handle Repair Kit



**DA3345 NEW**  
Door handle repair kit  
Defender - up to 2002



Photo by Peter Schulz

### Wheel Arch Cladding



Range Rover Evoque  
With automated parking system  
**LR044278** Front right hand side  
**LR044280** Front left hand side

### Glass Fitting Kit



**DA3219**  
Series  
Defender  
Rear door glass fitting kit

# SERVICE KITS



Everything You Need  
In One Handy Kit



# SERVICE KITS

## Service Kits

### Britpart Service Kits

Quality service parts manufactured to O.E. specification and competitively priced. Massive range of kits for all models.



Blue part numbers - Britpart filters & spark/heater plugs

### Britpart Service Kits with Oil

Quality service parts manufactured to O.E. specification and competitively priced with the relevant Britpart XD oil which meets Land Rover's specifications.



Purple part numbers ending in 'COM' - Britpart filters & spark/heater plugs with Britpart XD oil

*Servicing a Land Rover  
just got a whole lot  
easier with Britpart!*

**Ever started servicing a Land Rover and then suddenly realised you haven't ordered a filter or forgotten the sump plug washers?**

Well now thanks to Britpart with one simple part number you can order your Land Rover kit safe in the knowledge that all the parts you need will be there for you to complete the job. No more half-finished services!

### Land Rover Service Kits

A wide range of service kits using genuine filters and spark/heater plugs.



Green part numbers ending in 'LR' - Genuine filters & spark/heater plugs

### Alternative Brand Service Kits

Britpart stock a wide range of alternative brand service kits with OEM brands including Coopers, Mann, Mahle, Champion & NGK.



Pictures for illustrative purposes only

Red part numbers ending in 'P' - OEM filters & spark/heater plugs

### Britpart Service Kits with Cataclean

Quality service parts manufactured to O.E. specification and competitively priced with Cataclean - a fuel & exhaust system cleaner.



Light blue part numbers ending in 'CAT' - Britpart filters & spark/heater plugs with Cataclean



Photo by Roy Price

<b>DA6032</b>	Britpart kit
<b>Series 2¼ petrol - 1964 onwards</b>	
<b>Lucas ignition (fixed points)</b>	
1 x RTC3184	Oil filter
1 x 606168	Fuel filter (in-line)
4 x RTC3570	Spark plugs
1 x RTC3270	Points (fixed)
1 x RTC3472	Condenser
1 x 243959	Sump plug washer

<b>DA6033</b>	Britpart kit
<b>Series 2¼ petrol - 1964 onwards</b>	
<b>Lucas ignition (sliding points)</b>	
1 x RTC3184	Oil filter
1 x 606168	Fuel filter (in-line)
4 x RTC3570	Spark plugs
1 x RTC364	Points (sliding)
1 x RTC3288	Points (sliding)
1 x RTC6621	Condenser
1 x 243959	Sump plug washer

<b>DA6034</b>	Britpart kit
<b>Series 2¼ petrol - 1964 onwards</b>	
<b>(Ducellier ignition)</b>	
1 x RTC3184	Oil filter
1 x 606168	Fuel filter (in-line)
4 x RTC3570	Spark plugs
1 x RTC6625	Points
1 x RTC6620	Condenser
1 x 243959	Sump plug washer

*All the parts you need  
will be there for you  
to complete the job*

## Defender Service Kits

<b>DA6000</b>	Britpart kit
<b>Defender - 2½ petrol 7:1 compression ratio</b>	
1 x ERR3340	Oil filter
1 x NRC9238	Air filter
1 x JS660L	Fuel filter
1 x 243959	Sump plug washer
1 x FRC4808	Sump plug washer
4 x RTC3571	Spark plugs
<b>DA6001</b>	Britpart kit
<b>DA6001P</b>	Alternative brand kit
<b>DA6001COM</b>	Britpart kit with 10W 40 oil
<b>DA6001CAT NEW</b>	Britpart kit with Cataclean
<b>Defender - Turbo diesel &amp; 2½ naturally aspirated</b>	
1 x ERR3340	Oil filter
1 x NRC9238	Air filter
1 x RTC6079	Fuel filter
1 x FRC4808	Sump plug washer

<b>DA6002</b>	Britpart kit
<b>DA6002P</b>	Alternative brand kit
<b>DA6002COM</b>	Britpart kit with 10W 40 oil
<b>DA6002CAT NEW</b>	Britpart kit with Cataclean
<b>Defender - 200Tdi</b>	
1 x ERR3340	Oil filter
1 x NTC6660	Air filter
1 x AEU2147L	Fuel filter
1 x 213961L	Sump plug washer
1 x ETC7398	Sump plug washer
<b>DA6003</b>	Britpart kit
<b>DA6003P</b>	Alternative brand kit
<b>DA6003COM</b>	Britpart kit with 10W 40 oil
<b>DA6003CAT NEW</b>	Britpart kit with Cataclean
<b>Defender - 300Tdi</b>	
1 x ERR3340	Oil filter
1 x ESR2623	Air filter
1 x AEU2147L	Fuel filter
1 x UAM2857L	Sump plug washer
1 x ALU1403L	Sump plug washer

<b>DA6004</b>	Britpart kit
<b>DA6004P</b>	Alternative brand kit
<b>DA6004COM</b>	Britpart kit with 5W 30 oil
<b>DA6004CAT NEW</b>	Britpart kit with Cataclean
<b>DA6004PCAT NEW</b>	Alternative brand kit with Cataclean
<b>Defender - Td5</b>	
1 x LPX100590	Oil filter
1 x ESR4238	Air filter
1 x ERR6299	Rotor filter
1 x ESR4686	Fuel filter
1 x CDU1001L	Sump plug washer
<b>DA6004XD</b>	Britpart kit
<b>Defender - Td5</b>	
<i>Shorter than the standard filter which makes this one easier to fit and remove.</i>	
1 x ESR4238	Air filter
1 x ERR6299	Rotor filter
1 x ESR4686	Fuel filter
1 x CDU1001L	Sump plug washer

<b>DA6040</b>	Britpart kit
<b>DA6040P</b>	Alternative brand kit
<b>DA6040LR</b>	Land Rover brand kit
<b>DA6040COM</b>	Britpart kit with 5W 30 oil
<b>DA6040CAT NEW</b>	Britpart kit with Cataclean
<b>Defender - 2007 onwards</b>	
<b>2.4 &amp; 2.2 - up to DA444246</b>	
1 x LR004459	Oil filter
1 x WJ1500040	Fuel filter
1 x PHE500060	Air filter
1 x 1013938	Oil drain plug inc. rubber seal
<b>DA6109</b>	Britpart kit
<b>DA6109P</b>	Alternative brand kit
<b>DA6109LR</b>	Land Rover brand kit
<b>DA6109COM</b>	Britpart kit with 5W 30 oil
<b>DA6109CAT NEW</b>	Britpart kit with Cataclean
<b>Defender - 2007 onwards</b>	
<b>2.2 - DA444247 onwards</b>	
1 x LR058104	Oil filter
1 x WJ1500040	Fuel filter
1 x PHE500060	Air filter
1 x 1013938	Oil drain plug inc. rubber seal

## Freelander Service Kits

### Freelander 1

<b>DA6011</b>	Britpart kit
<b>Freelander 1 - 1.8 petrol - up to YA999999</b>	
1 x CDU1268	Oil filter
1 x ESR4103	Air filter
1 x JKR100200	Pollen filter
1 x ALU1403L	Sump plug washer
4 x NLP100290L	Spark plugs
<b>DA6012</b>	Britpart kit
<b>Freelander 1</b>	
<b>1.8 petrol - 1A000001 onwards</b>	
1 x CDU1268	Oil filter
1 x ESR4103	Air filter
1 x LR029773	Pollen filter
1 x ALU1403L	Sump plug washer
<b>DA6013</b>	Britpart kit
<b>DA6013P</b>	Alternative brand kit
<b>Freelander 1 - 2.0 diesel TCIE</b>	
1 x ERR5542	Oil filter
1 x ESR4103	Air filter
1 x WJN10046	Fuel filter
1 x JKR100200	Pollen filter
1 x ALU1403L	Sump plug washer

<b>DA6014</b>	Britpart kit
<b>DA6014P</b>	Alternative brand kit
<b>DA6014LR</b>	Land Rover brand kit
<b>Freelander 1 - Td4 - up to 2A209830</b>	
1 x LRF100150L	Oil filter
1 x LR007478	Air filter
1 x LR029773	Pollen filter
1 x ALU1403L	Sump plug washer
1 x MUN000010	Fuel filter
<b>DA6015</b>	Britpart kit
<b>DA6015P</b>	Alternative brand kit
<b>DA6015LR</b>	Land Rover brand kit
<b>DA6015COM</b>	Britpart kit with 10W 40 oil
<b>Freelander 1 - Td4 - 2A209831 onwards</b>	
1 x LRF100150L	Oil filter
1 x LR007478	Air filter
1 x LR029773	Pollen filter
1 x ALU1403L	Sump plug washer
1 x WJN000080	Fuel filter

### Freelander 2

<b>DA6038</b>	Britpart kit
<b>DA6038P</b>	Alternative brand kit
<b>DA6038LR</b>	Land Rover brand kit
<b>DA6038COM</b>	Britpart kit with 5W 30 oil
<b>DA6038CAT NEW</b>	Britpart kit with Cataclean
<b>Freelander 2 - 2.2 diesel</b>	
1 x LR001247	Oil filter
1 x LR005816	Air filter
1 x LR001313	Fuel filter
1 x LR056138	Cabin filter
1 x LR006295	Drain plug gasket
<b>DA6039</b>	Britpart kit
<b>DA6039P</b>	Alternative brand kit
<b>DA6039LR</b>	Land Rover brand kit
<b>Freelander 2 - 3.2 petrol</b>	
1 x LR001419	Oil filter
1 x LR005816	Air filter
6 x LR005483	Spark plugs
1 x LR056138	Cabin filter
1 x LR000506	Drain plug gasket
<b>DA6089</b>	Britpart kit
<b>DA6089P</b>	Alternative brand kit
<b>DA6089LR</b>	Land Rover brand kit
<b>Freelander 2 - 2.0 petrol</b>	
1 x LR096524	Oil filter
1 x LR029078	Air filter
1 x LR056138	Cabin filter
4 x LR025605	Spark plugs
1 x LR025048	Oil drain plug



#### Key

**Blue part numbers**

**Red part numbers ending in 'P'**

**Green part numbers ending in 'LR'**

**Purple part numbers ending in 'COM'**

**Light blue part numbers ending in 'CAT'**

Britpart filters & spark/heater plugs

OEM filters & spark/heater plugs

Genuine filters & spark/heater plugs

Britpart filters & spark/heater plugs with

Britpart XD oil

Britpart filters & spark/heater plugs with a bottle of Cataclean fuel & exhaust system cleaner

### Discovery 1

<b>DA6005</b>	Britpart kit
<b>Discovery 1 - 200Tdi - up to JA018272</b>	
1 x ERR3340	Oil filter
1 x NTC1435	Air filter
1 x AEU2147L	Fuel filter
1 x 213961L	Sump plug washer
<b>DA6006</b>	Britpart kit
<b>DA6006P</b>	Alternative brand kit
<b>DA6006COM</b>	Britpart kit with 10W 40 oil
<b>Discovery 1 - 200Tdi - JA018273 onwards</b>	
1 x ERR3340	Oil filter
1 x ESR1049	Air filter
1 x AEU2147L	Fuel filter
1 x 213961L	Sump plug washer
<b>DA6007</b>	Britpart kit
<b>DA6007P</b>	Alternative brand kit
<b>DA6007COM</b>	Britpart kit with 10W 40 oil
<b>DA6007CAT NEW</b>	Britpart kit with Cataclean
<b>Discovery 1 - 300Tdi</b>	
1 x ERR3340	Oil filter
1 x ESR1445	Air filter
1 x AEU2147L	Fuel filter
1 x UAM2857L	Sump plug washer
1 x ALU1403L	Sump plug washer

<b>DA6008</b>	Britpart kit
<b>Discovery 1 - 3.5 Efi</b>	
1 x ERR3340	Oil filter
1 x RTC4683	Air filter
8 x ERR3799	Spark plugs
1 x ESR4065	Fuel filter
1 x 213961L	Sump plug washer
<b>DA6009</b>	Britpart kit
<b>Discovery 1 - 3.9 Efi</b>	
1 x ERR3340	Oil filter
1 x ESR1445	Air filter
1 x ESR4065	Fuel filter
1 x ETC7398	Sump plug washer

### Discovery 2

<b>DA6004</b>	Britpart kit
<b>DA6004P</b>	Alternative brand kit
<b>DA6004COM</b>	Britpart kit with 5W 30 oil
<b>DA6004CAT NEW</b>	Britpart kit with Cataclean
<b>DA6004PCAT NEW</b>	Alternative brand kit with Cataclean
<b>Discovery 2 - Td5</b>	
1 x LPX100590	Oil filter
1 x ESR4238	Air filter
1 x ERR6299	Rotor filter
1 x ESR4686	Fuel filter
1 x CDU1001L	Sump plug washer
<b>DA6004XD</b>	Britpart kit
<b>Discovery 2 - Td5</b>	
<i>Shorter than the standard filter which makes this one easier to fit and remove.</i>	
1 x ESR4238	Air filter
1 x ERR6299	Rotor filter
1 x ESR4686	Fuel filter
1 x CDU1001L	Sump plug washer

## Discovery Service Kits

<b>DA6010</b>	Britpart kit
<b>DA6010P</b>	Alternative brand kit
<b>DA6010LR</b>	Land Rover brand kit
<b>Discovery 2 - V8 4.0</b>	
1 x ERR3340	Oil filter
1 x ESR4238	Air filter
8 x NLP100320	Spark plugs
1 x ALU1403L	Sump plug washer

[www.britpart.com/  
servicekits](http://www.britpart.com/servicekits)

*No more half  
finished services*



# SERVICE KITS

## Discovery Service Kits

### Discovery 3

<b>DA6035</b>	Britpart kit
<b>DA6035P</b>	Alternative brand kit
<b>DA6035LR</b>	Land Rover brand kit
<b>DA6035COM</b>	Britpart kit with 5W 30 oil
<b>DA6035CAT NEW</b>	Britpart kit with Cataclean
<b>Discovery 3 - 2.7 diesel - up to 6A999999</b>	
1 x 1311289	Oil filter
1 x PHE000112	Air filter
1 x LR010075	Fuel filter
1 x LR023977	Cabin filter
1 x 1013938	Oil drain plug inc. rubber seal
<b>DA6041</b>	Britpart kit
<b>DA6041P</b>	Alternative brand kit
<b>DA6041LR</b>	Land Rover brand kit
<b>DA6041COM</b>	Britpart kit with 5W 30 oil
<b>DA6041CAT NEW</b>	Britpart kit with Cataclean
<b>Discovery 3 - 2.7 diesel - 7A onwards</b>	
1 x 1311289	Oil filter
1 x PHE000112	Air filter
1 x LR023977	Cabin filter
1 x LR009705	Fuel filter
1 x 1013938	Oil drain plug inc. rubber seal
<b>DA6037</b>	Britpart kit
<b>DA6037P</b>	Alternative brand kit
<b>DA6037LR</b>	Land Rover brand kit
<b>Discovery 3 - 4.4 petrol</b>	
1 x LR031439	Oil filter
1 x PHE000112	Air filter
8 x LR005253	Spark plugs
1 x LR023977	Cabin filter
1 x 1013938	Oil drain plug inc. rubber seal
<b>DA6087P</b>	Alternative brand kit
<b>DA6087LR</b>	Land Rover brand kit
<b>Discovery 3 - 4.0 V6 petrol</b>	
1 x 4454116	Oil filter
(vehicles with engine oil cooler)	
1 x PHE000112	Air filter
1 x LR023977	Cabin filter
6 x LR000604	Spark plugs
1 x 1013938	Oil drain plug inc. rubber seal

### Discovery 4

<b>DA6041</b>	Britpart kit
<b>DA6041P</b>	Alternative brand kit
<b>DA6041LR</b>	Land Rover brand kit
<b>DA6041COM</b>	Britpart kit with 5W 30 oil
<b>DA6041CAT NEW</b>	Britpart kit with Cataclean
<b>Discovery 4 - 2.7 diesel</b>	
1 x 1311289	Oil filter
1 x PHE000112	Air filter
1 x LR023977	Cabin filter
1 x LR009705	Fuel filter
1 x 1013938	Oil drain plug inc. rubber seal
<b>DA6086</b>	Britpart kit
<b>DA6086P</b>	Alternative brand kit
<b>DA6086LR</b>	Land Rover brand kit
<b>DA6086CAT NEW</b>	Britpart kit with Cataclean
<b>Discovery 4 - 3.0 V6 diesel</b>	
1 x LR013148	Oil filter
1 x PHE000112	Air filter
1 x LR023977	Cabin filter
1 x LR009705	Fuel filter
1 x 1013938	Oil drain plug inc. rubber seal
<b>DA6087P</b>	Alternative brand kit
<b>DA6087LR</b>	Land Rover brand kit
<b>Discovery 4 - 4.0 V6 petrol</b>	
1 x 4454116	Oil filter
(vehicles with engine oil cooler)	
1 x PHE000112	Air filter
1 x LR023977	Cabin filter
6 x LR000604	Spark plugs
1 x 1013938	Oil drain plug inc. rubber seal
<b>DA6088</b>	Britpart kit
<b>DA6088P</b>	Alternative brand kit
<b>DA6088LR</b>	Land Rover brand kit
<b>Discovery 4 - 5.0 V8 petrol</b>	
1 x LR011279	Oil filter
2 x LR161843	Air filters
1 x LR023977	Cabin filter
8 x LR032080	Spark plugs
1 x 1013938	Oil drain plug inc. rubber seal

### Discovery Sport

<b>DA6089</b>	Britpart kit
<b>DA6089P</b>	Alternative brand kit
<b>DA6089LR</b>	Land Rover brand kit
<b>Discovery Sport - 2.0 petrol</b>	
1 x LR096524	Oil filter
1 x LR029078	Air filter
1 x LR056138	Cabin filter
4 x LR025605	Spark plugs
1 x LR025048	Oil drain plug
<b>DA6091</b>	Britpart kit
<b>DA6091P</b>	Alternative brand kit
<b>DA6091LR</b>	Land Rover brand kit
<b>DA6091CAT NEW</b>	Britpart kit with Cataclean
<b>Discovery Sport - 2.2 diesel</b>	
1 x LR001247	Oil filter
1 x LR029078	Air filter
1 x LR056138	Cabin filter
1 x LR001313	Fuel filter
1 x LR004304	Oil drain plug
1 x LR006295	Oil drain plug seal
<b>DA6123P</b>	Alternative brand kit
<b>DA6123LR</b>	Land Rover brand kit
<b>Discovery Sport - 2.0 single turbo diesel (AJ200) from GH000001</b>	
1 x LR073669	Oil filter
1 x LR071942	Air filter
1 x LR155579	Fuel filter
1 x LR079995	Foam pad
1 x LR056138	Cabin filter
1 x 1013938	Oil drain plug inc. rubber seal



www.britpart.com/  
servicekits

## Range Rover Service Kits

### Range Rover Classic

<b>DA6016</b>	Britpart kit
<b>Range Rover Classic - 3.5 - 1970 - 1975</b>	
1 x RTC3186	Oil filter
2 x 605191	Air filters
1 x JS660L	Fuel filter
8 x RTC3573	Spark plugs
1 x 213961L	Sump plug washer
2 x 603330	Flame traps
1 x RTC6623	Points (fixed)
1 x RTC3472	Condenser
<b>DA6017</b>	Britpart kit
<b>Range Rover Classic - 3.5 - 1975 - 1982</b>	
1 x ERR3340	Oil filter
2 x 605191	Air filters
1 x JS660L	Fuel filter
8 x RTC3573	Spark plugs
1 x 213961L	Sump plug washer
2 x 603330	Flame traps
1 x RTC6623	Points (fixed)
1 x RTC3472	Condenser
<b>DA6018</b>	Britpart kit
<b>Range Rover Classic - 3.5 - 1982 - 1983</b>	
1 x ERR3340	Oil filter
2 x 605191	Air filters
1 x JS660L	Fuel filter
8 x RTC3570	Spark plugs
1 x 213961L	Sump plug washer
2 x 603330	Flame traps
1 x RTC6626	Points (sliding)
1 x RTC3472	Condenser

<b>DA6019</b>	Britpart kit
<b>Range Rover Classic - 3.5 - 1984 - 1986</b>	
1 x ERR3340	Oil filter
2 x 605191	Air filters
1 x JS660L	Fuel filter
8 x RTC3570	Spark plugs
1 x 213961L	Sump plug washer
2 x 603330	Flame traps
<b>DA6020</b>	Britpart kit
<b>Range Rover Classic - 3.5 carb - 1986 - 1991</b>	
1 x ERR3340	Oil filter
2 x 605191	Air filters
1 x JS660L	Fuel filter
8 x RTC3812	Spark plugs
1 x 213961L	Sump plug washer
2 x 603330	Flame traps
<b>DA6021</b>	Britpart kit
<b>Range Rover Classic - 3.5/3.9 Efi 1986 - 1991 up to GA464553</b>	
1 x ERR3340	Oil filter
1 x RTC4683	Air filter
1 x NTC5958	Fuel filter
1 x 213961L	Sump plug washer

<b>DA6022</b>	Britpart kit
<b>Range Rover Classic - 3.9 Efi 1986 - 1994 from HA464554 up to LA647644</b>	
1 x ERR3340	Oil filter
1 x RTC4683	Air filter
1 x ESR4065	Fuel filter
1 x 213961L	Sump plug washer
<b>DA6023</b>	Britpart kit
<b>Range Rover Classic - 3.9 Efi 1992 - 1994 - MA647645 onwards</b>	
1 x ERR3340	Oil filter
1 x ESR1445	Air filter
1 x ESR4065	Fuel filter
8 x ETC7244	Spark plugs
1 x 213961L	Sump plug washer
<b>DA6024</b>	Britpart kit
<b>Range Rover Classic - 4.2 - 1992 - 1994</b>	
1 x ERR3340	Oil filter
1 x ESR1445	Air filter
1 x ESR4065	Fuel filter
8 x ERR3799	Spark plugs
1 x 213961L	Sump plug washer

<b>DA6006</b>	Britpart kit
<b>DA6006P</b>	Alternative brand kit
<b>DA6006COM</b>	Britpart kit with 10W 40 oil
<b>Range Rover Classic - 200Tdi</b>	
1 x ERR3340	Oil filter
1 x ESR1049	Air filter
1 x AEU2147L	Fuel filter
1 x 213961L	Sump plug washer
<b>DA6007</b>	Britpart kit
<b>DA6007P</b>	Alternative brand kit
<b>DA6007COM</b>	Britpart kit with 10W 40 oil
<b>DA6007CAT NEW</b>	Britpart kit with Cataclean
<b>Range Rover Classic - 300Tdi</b>	
1 x ERR3340	Oil filter
1 x ESR1445	Air filter
1 x AEU2147L	Fuel filter
1 x UAM2857L	Sump plug washer
1 x ALU1403L	Sump plug washer

#### Key

**Blue part numbers** - Britpart filters & spark/heater plugs  
**Red part numbers ending in 'P'** - OEM filters & spark/heater plugs  
**Green part numbers ending in 'LR'** - Genuine filters & spark/heater plugs  
**Purple part numbers ending in 'COM'** - Britpart filters & spark/heater plugs with Britpart XD oil  
**Light blue part numbers ending in 'CAT'** - Britpart filters & spark/heater plugs with a bottle of Cataclean fuel & exhaust system cleaner

### Range Rover P38

<b>DA6025</b>	Britpart kit
<b>Range Rover P38 - 4.0/4.6 up to TA346793 &amp; from WA376580 up to WA385948</b>	
1 x ERR3340	Oil filter
1 x ESR341	Air filter
1 x ESR4065	Fuel filter
8 x ERR3799	Spark plugs
2 x LR030219	Pollen filters
1 x UAM2857L	Sump plug washer
1 x ALU1403L	Sump plug washer
<b>DA6026</b>	Britpart kit
<b>Range Rover P38 - 4.0/4.6 from VA346794 up to VA376579 &amp; from WA385949 onwards</b>	
1 x ERR3340	Oil filter
1 x ESR4238	Air filter
1 x ESR4065	Fuel filter
8 x ERR3799	Spark plugs
2 x LR030219	Pollen filters
1 x UAM2857L	Sump plug washer
1 x ALU1403L	Sump plug washer

<b>DA6027</b>	Britpart kit
<b>DA6027P</b>	Alternative brand kit
<b>Range Rover P38 - 2.5 DT to engine no. 33978348 up to (Dec 1995) type A oil filter</b>	
1 x STC2180	Oil filter type A
1 x ESR341	Air filter
1 x STC2827	Fuel filter
2 x LR030219	Pollen filters
1 x VYX000040	Sump plug washer
<b>DA6028</b>	Britpart kit
<b>DA6028P</b>	Alternative brand kit
<b>Range Rover P38 - 2.5 DT from engine no. 33988348 from (Dec 1995) up to TA346793 type B oil filter</b>	
1 x STC3350	Oil filter type B
1 x ESR341	Air filter
1 x STC2827	Fuel filter
2 x LR030219	Pollen filters
1 x VYX000040	Sump plug washer

<b>DA6029</b>	Britpart kit
<b>DA6029P</b>	Alternative brand kit
<b>Range Rover P38 - 2.5 DT from engine no. 33988348 from (Dec 1995) from TA346794 type B oil filter</b>	
1 x STC3350	Oil filter type B
1 x ESR4238	Air filter
1 x STC2827	Fuel filter
2 x LR030219	Pollen filters
1 x VYX000040	Sump plug washer



No more half  
finished services



**Range Rover L322**

<b>DA6030</b>	Britpart kit	<b>DA6065</b>	Britpart kit
<b>DA6030P</b>	Alternative brand kit	<b>DA6065P</b>	Alternative brand kit
<b>DA6030LR</b>	Land Rover brand kit	<b>DA6065LR</b>	Land Rover brand kit
<b>DA6030COM</b>	Britpart kit with SW 30 oil	<b>Range Rover L322 - 4.4 V8 AJ petrol &amp; 4.2 Supercharged</b>	
<b>Range Rover L322 - 3.0 diesel</b>		1 x LR031439	Oil filter
1 x LPZ000020	Oil filter	1 x PHE500021	Air filter
1 x PHE000040	Air filter	1 x LR032199	Cabin filter
1 x WFL000070	Fuel filter	8 x LR005253	Spark plugs
1 x LR032199	Pollen filter	1 x 1013938	Oil drain plug inc. rubber seal
1 x VYX000040	Sump plug washer	<b>DA6066</b>	Britpart kit
<b>DA6031</b>	Britpart kit	<b>DA6066P</b>	Alternative brand kit
<b>DA6031P</b>	Alternative brand kit	<b>DA6066LR</b>	Land Rover brand kit
<b>DA6031LR</b>	Land Rover brand kit	<b>Range Rover L322 - 3.6 V8 diesel</b>	
<b>Range Rover L322 - 4.4 V8 M62</b>		1 x LR002338	Oil filter
1 x LPW500030	Oil filter	1 x PHE500021	Air filter
1 x PHE000050	Air filter	1 x LR032199	Cabin filter
1 x LR032199	Pollen filter	1 x WJ1500030	Fuel filter
1 x VYX000040	Sump plug washer	1 x 1013938	Oil drain plug inc. rubber seal
8 x LR021006	Spark plugs		

<b>DA6067</b>	Britpart kit
<b>DA6067P</b>	Alternative brand kit
<b>DA6067LR</b>	Land Rover brand kit
<b>Range Rover L322 - 4.4 V8 diesel</b>	
1 x LR022896	Oil filter
2 x LR161843	Air filters
1 x LR032199	Cabin filter
1 x LR029098	Fuel filter
1 x 1013938	Oil drain plug inc. rubber seal
<b>DA6068</b>	Britpart kit
<b>DA6068P</b>	Alternative brand kit
<b>DA6068LR</b>	Land Rover brand kit
<b>Range Rover L322 - 5.0 V8 petrol</b>	
1 x LR011279	Oil filter
2 x LR161843	Air filters
1 x LR032199	Cabin filter
8 x LR032080	Spark plugs
1 x 1013938	Oil drain plug inc. rubber seal

**Range Rover L405**

<b>DA6095</b>	Britpart kit	<b>DA6097</b>	Britpart kit
<b>DA6095P</b>	Alternative brand kit	<b>DA6097P</b>	Alternative brand kit
<b>DA6095LR</b>	Land Rover brand kit	<b>DA6097LR</b>	Land Rover brand kit
<b>Range Rover - 3.0 V6 diesel</b>		<b>Range Rover - 3.0 V6 petrol - up to EA128397</b>	
1 x LR013148	Oil filter	1 x LR011279	Oil filter
2 x LR161843	Air filter	2 x LR161843	Air filter
1 x LR041978	Fuel filter	1 x LR036369	Cabin filter
1 x LR036369	Cabin filter	6 x LR041664	Spark plugs
1 x 1013938	Oil drain plug inc. rubber seal	1 x 1013938	Oil drain plug inc. rubber seal
<b>DA6096</b>	Britpart kit	<b>DA6098</b>	Britpart kit
<b>DA6096P</b>	Alternative brand kit	<b>DA6098LR</b>	Land Rover brand kit
<b>DA6096LR</b>	Land Rover brand kit	<b>Range Rover - 3.0 V6 petrol - EA128398 onwards</b>	
<b>Range Rover - 4.4 V8 diesel</b>		1 x LR011279	Oil filter
1 x LR022896	Oil filter	2 x LR161843	Air filter
2 x LR161843	Air filter	1 x LR036369	Cabin filter
1 x LR029098	Fuel filter	6 x LR050998	Spark plugs
1 x LR036369	Cabin filter	1 x 1013938	Oil drain plug inc. rubber seal
1 x 1013938	Oil drain plug inc. rubber seal		

<b>DA6099</b>	Britpart kit
<b>DA6099P</b>	Alternative brand kit
<b>DA6099LR</b>	Land Rover brand kit
<b>Range Rover - 5.0 V8 petrol naturally aspirated &amp; supercharged - 2014 MY</b>	
1 x LR011279	Oil filter
2 x LR161843	Air filter
1 x LR036369	Cabin filter
8 x LR032080	Spark plugs
1 x 1013938	Oil drain plug inc. rubber seal
<b>DA6122</b>	Britpart kit
<b>DA6122P</b>	Alternative brand kit
<b>DA6122LR</b>	Land Rover brand kit
<b>Range Rover - 2.0 turbo petrol - FA000001 onwards</b>	
1 x LR096524	Oil filter
1 x LR161843	Air filter
1 x LR036369	Cabin filter
4 x LR025605	Spark plugs
1 x LR025048	Oil drain plug

**Range Rover Sport - Mk1**

<b>DA6035</b>	Britpart kit
<b>DA6035P</b>	Alternative brand kit
<b>DA6035LR</b>	Land Rover brand kit
<b>DA6035COM</b>	Britpart kit with SW 30 oil
<b>DA6035CAT NEW</b>	Britpart kit with Cataclean
<b>Range Rover Sport - 2.7 diesel up to 6A999999</b>	
1 x 1311289	Oil filter
1 x PHE000112	Air filter
1 x LR010075	Fuel filter
1 x LR023977	Cabin filter
1 x 1013938	Oil drain plug inc. rubber seal
<b>DA6048</b>	Britpart kit
<b>DA6048P</b>	Alternative brand kit
<b>DA6048LR</b>	Land Rover brand kit
<b>Range Rover Sport - 2.7 diesel from 7A000001</b>	
1 x 1311289	Oil filter
1 x PHE000112	Air filter
1 x LR009705	Fuel filter
1 x LR023977	Cabin filter
1 x 1013938	Oil drain plug inc. rubber seal
<b>DA6036</b>	Britpart kit
<b>DA6036P</b>	Alternative brand kit
<b>DA6036LR</b>	Land Rover brand kit
<b>Range Rover Sport - 3.6 diesel</b>	
1 x LR002338	Oil filter
1 x PHE000112	Air filter
1 x LR009705	Fuel filter
1 x LR023977	Cabin filter
2 x 1013938	Oil drain plug inc. rubber seal
<b>DA6037</b>	Britpart kit
<b>DA6037P</b>	Alternative brand kit
<b>DA6037LR</b>	Land Rover brand kit
<b>Range Rover Sport - 4.2/4.4 petrol</b>	
1 x LR031439	Oil filter
1 x PHE000112	Air filter
8 x LR005253	Spark plugs
1 x LR023977	Cabin filter
1 x 1013938	Oil drain plug inc. rubber seal

<b>DA6086</b>	Britpart kit
<b>DA6086P</b>	Alternative brand kit
<b>DA6086LR</b>	Land Rover brand kit
<b>DA6086CAT NEW</b>	Britpart kit with Cataclean
<b>Range Rover Sport - 3.0 V6 diesel</b>	
1 x LR013148	Oil filter
1 x PHE000112	Air filter
1 x LR023977	Cabin filter
1 x LR009705	Fuel filter
1 x 1013938	Oil drain plug inc. rubber seal
<b>DA6088</b>	Britpart kit
<b>DA6088P</b>	Alternative brand kit
<b>DA6088LR</b>	Land Rover brand kit
<b>Range Rover Sport - 5.0 V8 petrol</b>	
1 x LR011279	Oil filter
2 x LR161843	Air filters
1 x LR023977	Cabin filter
8 x LR032080	Spark plugs
1 x 1013938	Oil drain plug inc. rubber seal
<b>DA6095</b>	Britpart kit
<b>DA6095P</b>	Alternative brand kit
<b>DA6095LR</b>	Land Rover brand kit
<b>Range Rover Sport - 3.0 V6 diesel - EA000001 onwards</b>	
1 x LR013148	Oil filter
2 x LR161843	Air filter
1 x LR041978	Fuel filter
1 x LR036369	Cabin filter
1 x 1013938	Oil drain plug inc. rubber seal

**Range Rover Sport - Mk2**

<b>DA6096</b>	Britpart kit
<b>DA6096P</b>	Alternative brand kit
<b>DA6096LR</b>	Land Rover brand kit
<b>Range Rover Sport - 2014 onwards - 4.4 V8 diesel - BA000001 onwards</b>	
1 x LR022896	Oil filter
2 x LR161843	Air filter
1 x LR029098	Fuel filter
1 x LR036369	Cabin filter
1 x 1013938	Oil drain plug inc. rubber seal
<b>DA6097</b>	Britpart kit
<b>DA6097P</b>	Alternative brand kit
<b>DA6097LR</b>	Land Rover brand kit
<b>Range Rover Sport - 2014 onwards - 3.0 V6 petrol - up to EA301262</b>	
1 x LR011279	Oil filter
2 x LR161843	Air filter
1 x LR036369	Cabin filter
6 x LR041664	Spark plugs
1 x 1013938	Oil drain plug inc. rubber seal
<b>DA6098</b>	Britpart kit
<b>DA6098LR</b>	Land Rover brand kit
<b>Range Rover Sport - 2014 onwards - 3.0 V6 petrol - EA301263 onwards</b>	
1 x LR011279	Oil filter
2 x LR161843	Air filter
1 x LR036369	Cabin filter
6 x LR050998	Spark plugs
1 x 1013938	Oil drain plug inc. rubber seal

<b>DA6099</b>	Britpart kit
<b>DA6099P</b>	Alternative brand kit
<b>DA6099LR</b>	Land Rover brand kit
<b>Range Rover Sport - 2014 onwards - 5.0 V8 petrol naturally aspirated &amp; supercharged</b>	
1 x LR011279	Oil filter
2 x LR161843	Air filter
1 x LR036369	Cabin filter
8 x LR032080	Spark plugs
1 x 1013938	Oil drain plug inc. rubber seal
<b>DA6122</b>	Britpart kit
<b>DA6122P</b>	Alternative brand kit
<b>DA6122LR</b>	Land Rover brand kit
<b>Range Rover Sport - 2014 onwards - 2.0 turbo petrol from FA000001</b>	
1 x LR096524	Oil filter
1 x LR161843	Air filter
1 x LR036369	Cabin filter
4 x LR025605	Spark plugs
1 x LR025048	Oil drain plug

**Key**

- Blue part numbers** Britpart filters & spark/heater plugs
- Red part numbers ending in 'P'** OEM filters & spark/heater plugs
- Green part numbers ending in 'LR'** Genuine filters & spark/heater plugs
- Purple part numbers ending in 'COM'** Britpart filters & spark/heater plugs with Britpart XD oil
- Light blue part numbers ending in 'CAT'** Britpart filters & spark/heater plugs with a bottle of Cataclean fuel & exhaust system cleaner

**Range Rover Evoque**

<b>DA6089</b>	Britpart kit
<b>DA6089P</b>	Alternative brand kit
<b>DA6089LR</b>	Land Rover brand kit
<b>Range Rover Evoque - 2.0 petrol</b>	
1 x LR096524	Oil filter
1 x LR029078	Air filter
1 x LR056138	Cabin filter
4 x LR025605	Spark plugs
1 x LR025048	Oil drain plug

<b>DA6091</b>	Britpart kit
<b>DA6091P</b>	Alternative brand kit
<b>DA6091LR</b>	Land Rover brand kit
<b>DA6091CAT NEW</b>	Britpart kit with Cataclean
<b>Range Rover Evoque - 2.2 diesel</b>	
1 x LR001247	Oil filter
1 x LR029078	Air filter
1 x LR056138	Cabin filter
1 x LR001313	Fuel filter
1 x LR004304	Oil drain plug
1 x LR006295	Oil drain plug seal

<b>DA6123P</b>	Alternative brand kit
<b>DA6123LR</b>	Land Rover brand kit
<b>Range Rover Evoque - 2.0 single turbo diesel (AJ200) from GH000001</b>	
1 x LR073669	Oil filter
1 x LR071942	Air filter
1 x LR155579	Fuel filter
1 x LR079995	Foam pad
1 x LR056138	Cabin filter
1 x 1013938	Oil drain plug inc. rubber seal

**Service Sticker**



**SERVICESTICKERPK**

Helpful stickers to remind customers when they are due another service. Pack of 25



# SERVICE KITS

## Automatic Transmission Service & Conversion Kits

Degradation in oil can lead to judder, noise and a deterioration in gear change quality. It is recommended that oil and filters are changed after 50,000 to 75,000 miles on all 5, 6 & 8 speed automatic gearboxes to ensure optimum performance.

### 6-Speed Filter Conversion Kit

This is an easy change filter conversion kit for all vehicles with either a 6HP26 or 6HP28 ZF 6-speed automatic gearbox. From the factory a fluid and filter change on this transmission is a very lengthy process. The sump and filter are normally one piece and fitting involves jacking the engine up and unbolting the mounts, plus the removal of the exhaust.

Suitable for -  
Discovery 3 & Discovery 4  
Range Rover Sport - 2005 - 2013  
Range Rover L322

The fitting of this kit is far easier. Once the fluid has been drained from the transmission simply remove the bolts from the old unit. Cut the old plastic sumps filter tube with a hacksaw. Slide the old sump out and remove the other end of the sawn off filter tube. The new separate filter can then be fitted and the new sump pan slides into place and is bolted up with the new gasket supplied. Once secure the transmission can be filled as per manufacturer's instructions. The new sump pan also has the added benefit that it is manufactured in durable steel rather than the plastic of the original item - LR007474. Also see DA6085 & DA6085G in service kit section. 7 litres needed for oil change.

#### Britpart Kit

<b>DA2142</b>	Filter conversion kit
<b>DA2143</b>	Replacement filter
<b>DA2144</b>	Replacement gasket
<b>TYK500050</b>	Ravenol fluid - 1 litre

#### OEM Kit

<b>DA2142G</b>	Filter conversion kit - OEM
<b>DA2143G</b>	Replacement filter - OEM
<b>DA2144G</b>	Replacement gasket - OEM
<b>TYK500050G</b>	ZF Lifeguard fluid - 1 litre



### 6-Speed Fluid Change Kit

Automatic transmission fluid change kit for vehicles with either a 6HP26 or 6HP28 ZF 6-speed automatic gearbox. Ideal for high mileage vehicles and towing vehicles. Kit comprises of pan assembly, transmission fluid, screws, sleeve & plugs.

Suitable for -  
Discovery 3  
Discovery 4  
Range Rover Sport - 2005 - 2013  
Range Rover L322

**DA6085** Britpart pan with Ravenol oil  
**DA6085G** ZF pan with ZF oil



### 5-Speed Gearbox Service Kit



### 8-Speed Fluid Change Kit

Automatic transmission fluid change kits for vehicles with ZF 8HP70 8-speed automatic gearbox. Ideal for high mileage vehicles and towing vehicles. Kit comprises of pan assembly, transmission fluid, screws & plug.

Discovery Sport  
Discovery 4  
Range Rover Evoque - 2012 - 2018  
Range Rover Sport - 2010 - 2013  
Range Rover Sport - 2014 onwards  
Range Rover L322 - 2010 - 2012  
Range Rover L405

**DA3383G NEW** OEM Pan (LR065238G) and ZF oil  
**DA3383 NEW** Pan (LR065238) and Ravenol oil



### 4-Speed Gearbox Service Kit



**DA4500**  
Defender - up to 2007  
Discovery 1  
Discovery 2  
Range Rover Classic  
Range Rover P38  
Kit comprises of oil screen, seals, o-rings and sealing washer.



# CONSUMMABLES

Consumables To Keep  
Your Land Rover  
Running Smoothly

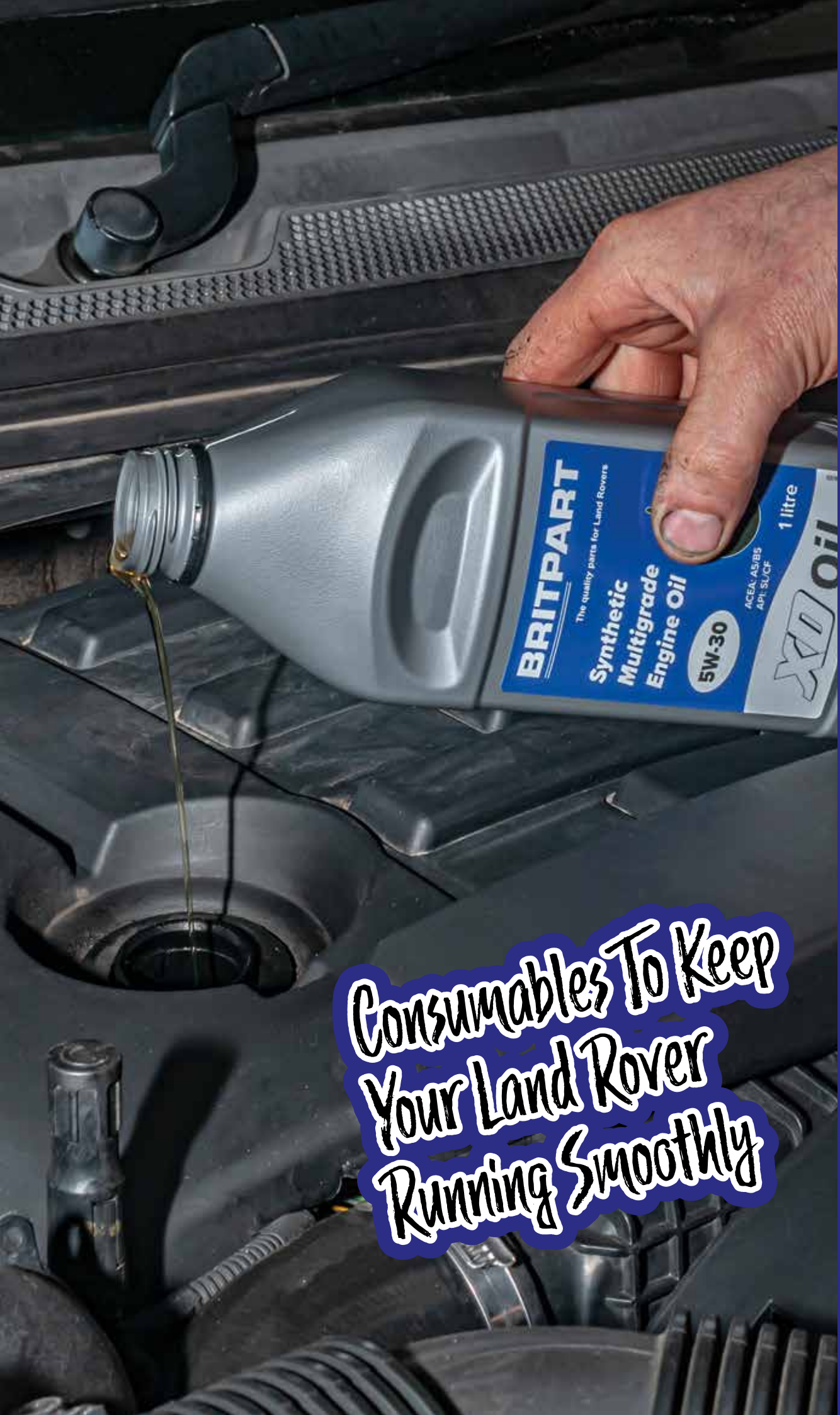



### Britpart XD Oils



DA1331

#### 10W-40 Semi-Synthetic Multi-grade Engine Oil

<b>DA1331</b>	Britpart XD 10W-40	ACEA: A3/B4	/	API: SN/CF	1 litre
<b>DA1530</b>	Britpart XD 10W-40	ACEA: A3/B4	/	API: SN/CF	5 litres

#### Product Description

Britpart XD 10W-40 is a semi-synthetic multi-grade engine oil manufactured using high quality additives and base oils for fuel efficiency and superior performance for petrol and diesel engines of passenger cars and light commercial vehicles. Meets ACEA and API specifications required by a large number of cars and light commercial vehicles. The additive technology coupled with advanced base fluids also ensures a high level of component protection and cleanliness when operating in severe conditions. Engine design has changed rapidly over recent years and increased output from smaller units, coupled with reduced engine oil sump capacity, has put greater demands on the lubricant. Britpart XD 10W-40 is designed to meet these challenges. It provides excellent stay in grade performance for a wide range of engines.

#### Applications

Britpart XD 10W-40 is suitable for use in normally aspirated and turbocharged engines in passenger cars and light commercial vehicles, where any of the performance levels listed are required. It is miscible with all synthetic and mineral based engine oils.

#### Performance Levels

- > API - SN / CF
- > ACEA - A3 / B4
- > MB - 229.3
- > VW - 501.00 / 505.00
- > Renault - RN 0700 / 0710

#### Benefits

- > Suitable for a wide range of vehicles
- > Excellent high and low temperature stability
- > Excellent cold starting
- > Improved oil consumption and emissions

*Multi-grade engine oils  
manufactured using  
high quality additives*

#### 5W-30 Synthetic Multi-grade Engine Oil

<b>DA1333</b>	Britpart XD 5W-30	ACEA: A5/B5	/	API: SL/CF	1 litre
<b>DA1529</b>	Britpart XD 5W-30	ACEA: A5/B5	/	API: SL/CF	5 litres

#### Product Description

Britpart 5W-30 is a synthetic, fuel-efficient multi-grade engine oil complying to Ford specification WSS-M2C913-D and WSS-M2C913-C and meeting the STJLR.03.5003 Jaguar Land Rover specification. Britpart 5W-30 is a synthetic multi-grade engine oil formulated with highly refined synthetic base stocks and the very latest in advanced additive technology. The carefully selected components combine to provide the user with improved fuel economy benefits, greater robustness to fuels containing increased levels of bio-diesel and superior soot handling properties. This highly stable, stay-in-grade product allows extended oil drain intervals to be achieved.

#### Applications

Britpart XD 5W-30 is an ideal choice in many normally aspirated and turbocharged petrol and diesel engines designed to use a fuel saving engine lubricant. In particular, Britpart 5W-30 can be used in all Ford diesel engines (except Ford Ka TDCi 2009 onwards and Galaxy 1.9 TDi 2000-2006). It is strongly recommended for use in Transit models (2012 onwards) carrying the 2.2 Duratorq TDCi engine where only WSS-M2C913-D lubricants can be used.

#### Performance Levels

- > API - SL / CF
- > ACEA - A5 / B5
- > Ford WSS-M2C913-D
- > STJLR.03.5003
- > RN0700

#### Benefits

- > Complies with Ford specification WSS-M2C913-D
- > Complies with Ford specification WSS-M2C913-C
- > Extended drain capability
- > Fully backwards compatible with the earlier specifications of WSS-M2C 913-A and 913-B
- > Stay-in-grade formulation
- > Excellent low temperature stability for improved flow rates
- > Improved fuel efficiency



DA1333



# XD oil

*Formulated from a blend of  
top quality solvent refined  
mineral base oils*

#### 20W-50 Mineral Engine Oil

<b>DA1822</b>	Britpart XD 20W-50	ACEA: A3/B3	/	API: SL/CF	1 litre
<b>DA1823</b>	Britpart XD 20W-50	ACEA: A3/B3	/	API: SL/CF	5 litres
<b>DA1824</b>	Britpart XD 20W-50	ACEA: A3/B3	/	API: SL/CF	20 litres

#### Product Description

Britpart XD 20W-50 is a traditional mineral oil based engine oil suitable for use in petrol fuelled passenger cars and light duty diesel vehicles. It is formulated from a blend of top quality solvent refined mineral base oils with established detergent/dispersant additive technology and incorporating viscosity index improver polymers to deliver the 20W-50 multi-grade viscosity profile. The 20W-50 viscosity grade classification is designed for severe service conditions and ensures optimum lubrication protection and engine performance in warmer climate conditions.

#### Applications

Applications for the 20W-50 are older model petrol vehicles fitted with an oil filter, especially V8's and 200Tdi/300Tdi high mileage vehicles with excessive oil consumption. Also to be used in hot climates where a 15W-40 is normally recommended. Not suitable for TD5 onwards.

#### Performance Levels

- > ACEA: A3/B3
- > API: SL/CF
- > MB: 229.1

#### Benefits

- > High temperature performance
- > Protects against ring sticking at high temperatures
- > Maintains oil performance
- > Minimises oil consumption
- > High standard of engine cleanliness
- > Excellent sludge control protection designed for stop-go city motoring
- > Long lasting dispersant, anti-wear and corrosion protection

#### Technical Data\*

- > 20W-50
- > Specific Gravity @ 15°C 0.885
- > Kinematic Viscosity @ 100°C cSt 18.2
- > Kinematic Viscosity @ 40°C cSt 153
- > Viscosity Index 133
- > Flash Point (COC °C) 220
- > Pour Point °C -30
- > TBN (mg KOH/g) 9

\*These are typical test results and don't constitute a specification.



DA1822

Engine Oils

<b>DA6287G</b>	Castrol Edge Professional C1 5W-30 SAE 5W-30; ACEA C1, C2. Land Rover specification - STJLR.03.5005	1 litre
<b>DA1425</b>	Castrol Edge Professional E 0W-30 SAE 0W-30; ACEA C2. Land Rover specification - STJLR.03.5007	1 litre
<b>DA3298</b>	Castrol Edge C5 0W-20 Land Rover specification STJLR.03.5006	1 litre
<b>DA1430</b>	Castrol Magnatec 10W-40 A3/B4 Its intelligent molecules will protect your car's engine during the critical warm up stage when up to 75% of engine wear occurs	1 litre
<b>DA1427</b>	Castrol Magnatec Stop-Start 5W-30 A5 Its intelligent molecules will protect your engine from the moment you start, every time you start, dramatically reducing stop-start wear	1 litre



Transmission & Drive Train Oils

<b>STC50531LR</b>	Automatic transmission fluid 402	1 litre
<b>STC4861LR</b>	Transmission fluid - transfer box	500ml
<b>STC9157</b>	LubeTech Manual transmission fluid 94 API GL4	5 litres
<b>VYK000010</b>	Gear oil - MTF94	1 litre
<b>STC9158</b>	LubeTech Manual transmission fluid 94 API GL4	1 litre
<b>STC4862G</b>	Texamatic 7045E	1 litre
Automatic transmission fluid. Provides top-tier protection to all applications where Dexron IIG type products are specified, offering excellent protection to automatic transmission and power steering systems.		
<b>LR006247G</b>	Castrol Syntrans 75W-90/API GL-4	1 litre
Multi-vehicle manual transmission fluid		
<b>STC4863G</b>	Mobile ATF LT 71141	1 litre
Automatic transmission fluid. Suitable for use in automatic transmissions and power steering systems.		
<b>TYK500050G</b>	ZF Lifeguard Fluid	1 litre
This high performance full synthetic oil for automatic transmissions has been exclusively developed and approved for ZF automatic transmissions only.		
<b>IYK500010G</b>	Transfer Fluid TF-0870 - OEM	1 litre
Use in active transfer case to provide a stable viscosity.		
<b>TYK500010G</b>	Castrol Differential SAF-XO SAE 75W-90	1 litre
Fully synthetic final drive lubricant recommended for most passenger car final drives.		
<b>LR003156G</b>	Castrol Differential EPX SAE 80W-90	1 litre
Mineral based multi-grade extreme pressure gear oil for the lubrication of spiral bevel and hypoid differentials. The product is also suitable for the lubrication of manual transmissions where the manufacturer recommends the use of an oil to API GL5.		
<b>LR019727LR</b>	Castrol Differential SAF Carbon Mod Plus SAE 75W-90	1 litre
Fully synthetic gear oil which can be used for axles with limited slip differentials.		
<b>LR024835G</b>	Castrol Syntrans FE 75W / API GL-4	1 litre
Multi-vehicle manual transmission fluid		



Ravenol Classic Oils

The need for Classic Oils?

Oils for modern engines need to comply with the latest API ratings and specific ACEA and OEM specifications concerned with improving fuel efficiency, extending oil drain intervals and exhaust treatment systems such as diesel particle filters.

A classic car engine has the opposite characteristics with cork/graphite/rope seals, low pressure gear driven oil pumps, larger oil galleries with greater dependence on "splash" and "cling" lubrication, lower revving with larger machining tolerances. This type of engine design demands a totally different lubricant. The range of Ravenol Classic Oils offers formulations that have been specially blended to meet the requirements of older vehicles.

Special anti-wear additives with the correct amount of zinc (ZDDP) are added to ensure that metal to metal contact and irreparable engine damage is prevented, especially to camshafts and followers, which can wear out in only a few thousand miles when using modern oils. The careful selection of appropriate corrosion inhibitors, special dispersant additives and the correct levels of detergency protect against pitting, the build-up of gums, lacquers, sludge, soot and metallic ash - the normal by-products of combustion.

[www.britpart.com/ravenol](http://www.britpart.com/ravenol)

Ravenol Classic SAE 30

**DA4963** 5 litres  
Monograde engine oil for pre-1960 Land Rovers

Ravenol Classic SE 20W-50

**DA4964** 5 litres  
Multi-grade engine oil for post 1960 petrol Land Rovers

Ravenol MZG EP 80W-90 GL4

**DA4965** 1 litre  
**DA1532** 4 litres  
Transmission oil for early Land Rover gearboxes, transfer boxes and differentials. Recommended for the lubrication of all manual transmissions, differential gears, transfer boxes and steering boxes of most early Land Rovers where a GL4 specification is called for.

Ravenol Octane Booster

**DA4966** 300ml  
Petrol engine lead replacement additive with octane booster. An environmentally-friendly valve seat lubricant and combustion enhancer which increases the octane rating by at least 3 points. It helps to prevent pinking and running on and allows more ignition advance, thus improving performance in the peak ranges. Especially suitable for low-grade or insufficient fuel quality. It helps to prevent wear and tear on valve seats and exhaust valves when using modern fuels in older engines.



**By using Ravenol Classic Oils in your classic Land Rover you are protecting both engine and transmission - for generations to come.**



### Ravenol Workshop Consumables

#### Engine Oils



**DA6289** 1 litre  
**DA6288** 5 litres  
**SFE Super Fuel Economy 5W-20**  
 Ravenol SFE 5W-20 is suitable for all petrol and diesel engines requiring a 5w20 grade fuel economy lubricant, and is especially developed to meet the requirements of the latest generation of Land Rover and Jaguar vehicles fitted with 5.0L V8 units.



**DA6376** 1 litre  
**DA6377** 5 litres  
**FLJ SAE 5W-30**  
 Ravenol FLJ SAE 5W-30 is a universal, fuel-saving, specially-composed motor oil for modern petrol and diesel engines both with and without turbochargers, for use in automobiles and vans with extended oil change intervals.



**DA6378** 1 litre  
**DA6379** 5 litres  
**VMO SAE 5W-40**  
 Universal synthetic low friction motor oil especially developed for pump-jet diesel engines. Moreover, this lubricant is suitable for gasoline and diesel engines in passenger cars and vans with and without turbo charger. Due to the specific composition Ravenol VMO SAE 5W-40 is suitable for use for several of the latest OEM requirements.



**DA6291** 1 litre  
**DA6292** 5 litres  
**FO 5W-30**  
 Ravenol FO 5W-30 is a fuel economy engine oil, special product for modern gasoline and passenger car diesel engines.



**DA1804** 1 litre  
**DA1813** 5 litres  
**Eco Synth ECS 0W-20**  
 A state-of-the-art PAO (Polyalphaolefin) based fully synthetic, smooth-running low-friction motor oil with Ravenol's patented USVO® and CleanSynto® technologies and is recommended for modern car petrol and diesel engines, including supercharged models, and for direct injection engines and hybrid vehicles under all operating conditions.



**DA1805** 1 litre  
**DA1814** 5 litres  
**FDS 5W-30**  
 A PAO (Polyalphaolefin) based, fully synthetic low friction motor oil with especially USVO® and proven CleanSynto® technologies for petrol and diesel engines with and without turbo-charging and direct injection. Ideal for use in all driving conditions such as in extreme stop-and-go traffic and high-speed motorway driving. It minimizes friction, wear and fuel consumption.



**DA1806** 1 litre  
**DA1815** 5 litres  
**FES 0W-30**  
 Fully synthetic, smooth-running low-friction motor oil with special USVO® and proven CleanSynto® technologies and is recommended for modern passenger car fuel and diesel engines, including supercharged models, and for direct injection engines under all operating conditions. Using additives with low ash content it offers excellent cold start characteristics.



**DA1807** 1 litre  
**DA1816** 4 litres  
**SSV Fuel Economy SAE 0W-30**  
 Achieves a high viscosity index and a considerable fuel saving through of its formulation with special base oils and PAO. The excellent cold start behaviour provides an optimum lubricating safety during the cold run phase.



**DA1808** 1 litre  
**DA1817** 5 litres  
**VDL 5W-40**  
 Full synthetic engine oil designed for modern high performance diesel engines where improved fuel efficiency and extended protection are demanded. Minimum evaporation properties, very high wear protection and improved detergent and dispersant characteristics make this suitable for use over extended drain intervals and the harshest of conditions.



**DA1809** 1 litre  
**DA1819** 5 litres  
**VST 5W-40**  
 Utilizes the positive properties of tungsten to smooth the surface structure of the motor, significantly improving mechanical efficiency. This guarantees optimal operation in all driving conditions, extreme stop and go in heavy traffic to high speed driving on motorways.



**DA6368** 1 litre  
**DA6369** 5 litres  
**TSi SAE 10W-40**  
 TSi 10W-40 is suitable for year round use in modern petrol & diesel cars. For use in turbo & non-turbocharged vehicles, multi-valve & direct injection diesel engines and is catalyst-compatible. Due to the specific high quality composition of TSi 10W-40, meets and exceeds the requirements of many leading OEM's, it also carries manufacturer approvals.



**DA6380** 1 litre  
**DA6381** 5 litres  
**Turbo-C HD-C SAE 15W-40**  
 It is perfectly suited as all-season motor oil for the mixed fleet. It can be used in the commercial vehicle sector for operation and extended oil change interval (up to 45,000 kilometres are possible) according to manufacturer's specifications.

## Ravenol Oil Guide

[www.britpart.com/ravenol](http://www.britpart.com/ravenol)

The database in this "Ravenol Oil Guide" is intended as a guide to enable you to choose the correct oil for your vehicle. It has been established with the greatest possible care by comparing the range of Ravenol lubricants to the standards and requirements of the vehicle manufacturer for normal use. Please note that all recommendations are based on information given to us by 3rd parties and we therefore cannot accept responsibility for the accuracy of the information given. We recommend that you consult the original Manufacturer's specification and in case of doubt please contact us.

SELECT VEHICLE MODEL	Discovery 2	SEARCH																																										
Discovery 2	<table border="1"> <thead> <tr> <th>Year</th> <th>Engine</th> <th>Oil</th> <th>Oil</th> <th>Oil</th> <th>Oil</th> <th>Oil</th> </tr> </thead> <tbody> <tr> <td>04.08 (0802)</td> <td>2000cc 170kW</td> <td>TSI 10W-40</td> <td>TSI 10W-40</td> <td>TSI 10W-40</td> <td>TSI 10W-40</td> <td>TSI 10W-40</td> </tr> <tr> <td>04.08 (0802)</td> <td>2000cc 150kW</td> <td>TSI 10W-40</td> <td>TSI 10W-40</td> <td>TSI 10W-40</td> <td>TSI 10W-40</td> <td>TSI 10W-40</td> </tr> <tr> <td>04.08 (0802)</td> <td>2000cc 130kW</td> <td>TSI 10W-40</td> <td>TSI 10W-40</td> <td>TSI 10W-40</td> <td>TSI 10W-40</td> <td>TSI 10W-40</td> </tr> <tr> <td>04.08 (0802)</td> <td>2000cc 110kW</td> <td>TSI 10W-40</td> <td>TSI 10W-40</td> <td>TSI 10W-40</td> <td>TSI 10W-40</td> <td>TSI 10W-40</td> </tr> <tr> <td>04.08 (0802)</td> <td>2000cc 90kW</td> <td>TSI 10W-40</td> <td>TSI 10W-40</td> <td>TSI 10W-40</td> <td>TSI 10W-40</td> <td>TSI 10W-40</td> </tr> </tbody> </table>	Year	Engine	Oil	Oil	Oil	Oil	Oil	04.08 (0802)	2000cc 170kW	TSI 10W-40	TSI 10W-40	TSI 10W-40	TSI 10W-40	TSI 10W-40	04.08 (0802)	2000cc 150kW	TSI 10W-40	TSI 10W-40	TSI 10W-40	TSI 10W-40	TSI 10W-40	04.08 (0802)	2000cc 130kW	TSI 10W-40	TSI 10W-40	TSI 10W-40	TSI 10W-40	TSI 10W-40	04.08 (0802)	2000cc 110kW	TSI 10W-40	TSI 10W-40	TSI 10W-40	TSI 10W-40	TSI 10W-40	04.08 (0802)	2000cc 90kW	TSI 10W-40	TSI 10W-40	TSI 10W-40	TSI 10W-40	TSI 10W-40	SEARCH
Year	Engine	Oil	Oil	Oil	Oil	Oil																																						
04.08 (0802)	2000cc 170kW	TSI 10W-40	TSI 10W-40	TSI 10W-40	TSI 10W-40	TSI 10W-40																																						
04.08 (0802)	2000cc 150kW	TSI 10W-40	TSI 10W-40	TSI 10W-40	TSI 10W-40	TSI 10W-40																																						
04.08 (0802)	2000cc 130kW	TSI 10W-40	TSI 10W-40	TSI 10W-40	TSI 10W-40	TSI 10W-40																																						
04.08 (0802)	2000cc 110kW	TSI 10W-40	TSI 10W-40	TSI 10W-40	TSI 10W-40	TSI 10W-40																																						
04.08 (0802)	2000cc 90kW	TSI 10W-40	TSI 10W-40	TSI 10W-40	TSI 10W-40	TSI 10W-40																																						

Use our handy online Ravenol Oil Guide to find the most suitable oils for your Land Rover - covers from early Defenders right through to current models.



Ravenol the renowned German Manufacturer is one of the most technically innovative companies in the lubricants industry. Ravenol prides itself on the special formulations, unique design and its exacting manufacturing processes that are individually tailored to suit customer needs. This is why the demand for Ravenol product is growing worldwide. In the advanced in-house laboratories products are carefully developed to meet and exceed the requirements of the major automotive manufacturers and to comply with all current and future regulations. Across the globe, Ravenol has earned an enviable reputation for innovation and technical excellence. Ravenol have developed an extensive range of products meeting and exceeding Land Rover requirements resulting in quieter running engines with improved fuel economy and smoother gear changes. Whichever Land Rover/Range Rover model you drive, wherever and however you drive it, Ravenol have developed a lubricant to meet your specific requirements. We at Britpart not only recommend the use of Ravenol lubricants in your Land Rover, but use them in our own fleet of Land Rovers, trucks and vans.

More information on all these Ravenol products at [www.britpart.com/ravenol](http://www.britpart.com/ravenol)

Ravenol Workshop Consumables

Transmission Oils



**STC4863** 1 litre  
**DA1579** 20 litres  
**ATF 5/4 HP Fluid**  
 Ravenol ATF 5/4 HP Fluid is primarily designed for use in ZF 4HP-series (4HP20, 4HP22, 4HP24) and 5HP-series (5HP18, 5HP19, 5HP24, 5HP30) automatic transmissions.



**DA6374** 1 litre  
**DA6375** 4 litres  
**ATF T-WS Lifetime Fluid**  
 An automatic transmission fluid based on the latest HC/HT and PAO synthetic technology. Due to the special formulation the durability is up to twice that of a comparable standard ATF oil.



**STC50531** 1 litre  
**ATF JF506E Fluid**  
 Ravenol ATF JF506E is primarily designed for use in JATCO JF506E 5-speed automatic transmissions used in Land Rover Freelander.



**LR052059** 1 litre  
**DGL SAE 75W-85 GL-5 LS**  
 A fully synthetic multi-grade PAO based hypoid transmission oil meeting API GL-5 specification with a specially co-ordinated additive treatment and 'limited slip' properties for manual transmissions and rear-axles.



**TYK500010** 1 litre  
**TYK500010-4L** 4 litres  
**TYK500010-20L** 20 litres  
**VSG 75W-90 Gear Oil**  
 Suitable for use in both synchromesh and non-synchromesh gearboxes and perfectly suited for use in highly stressed axle drives and differentials. Used in many high performance and motorsport applications as well as for road use in cars where maximum protection and fuel economy are desired.



**DA1826** 1 litre  
**MTF-1 SAE 75W-85**  
 Full synthetic, low-viscosity transmission oil for manual transmissions, transfer cases and differential gears. Designed to exceed the OEM requirements and specifications for a fuel efficient lubricant which combines outstanding performance at both hot and cold temperature extremes, even with extended oil change intervals.



**TYK500030** 1 litre  
**TYK500030-4L** 4 litres  
**MTF-2 75W-80 Gear Oil**  
 Ravenol MTF-2 SAE 75W-80 is ideally suited to ensure smooth and efficient operation of modern transmissions subject to very high mechanical and thermal loads of gear oils, even at the longest oil change intervals.



**DA1811** 1 litre  
**DA1820** 4 litres  
**MTF-3 75W**  
 A fully synthetic, fuel efficient gear oil formulated using the latest PAO synthetic technology and special additive systems to combat very high mechanical and thermal loads, even at the longest oil change intervals.



**TYK500050** 1 litre  
**TYK500050-4L** 4 litres  
**TYK500050-20L** 20 litres  
**TYK500050-208L** 208 litres  
**ATF 6HP Fluid**  
 Ravenol ATF 6 HP Fluid was developed specifically for use in the latest ZF 6HP-series transmissions, 6HP19, 6HP21, 6HP26, 6HP28, 6HP32, 6HP34, also for 5-speed automatic transmission 5HP-series. It is backwardly compatible for all earlier versions of ZF 4.



**LR019727** 1 litre  
**Multi-disc Locking Differentials Semi-synthetic Lubricant**  
 Ravenol MDL multi-disc locking differentials was developed specifically for use in lamella limited slip differentials.



**IYK500010** 1 litre  
**IYK500010-20L** 20 litres  
**Transfer Fluid TF-0870**  
 Ravenol Transfer Fluid TF-0870 was developed for use in active transfer case and provides a stable viscosity even under the highest loads.



**DA6372** 1 litre  
**DA6373** 4 litres  
**ATF Dexron D II**  
 It was developed for the use in automatic transmissions, hydro steering mechanisms, converters and power transmissions and can be used as a universal ATF (automatic transmission fluid) for all vehicles and working machines.



**LR022460** 1 litre  
**LR002748** 1 litre  
**ATF T-IV Fluid**  
 Ravenol ATF T-IV Fluid was primarily developed for use in the latest Aisin Warner and Toyota transmissions found in many modern European and Japanese vehicles, and its versatile formulation means it can also be used to replace older T, T-II and T-III fluids where required, as well as fulfilling many other manufacturer requirements.



**STC4862** 1 litre  
**ATF Dexron III H**  
 Ravenol ATF Dexron III H was primarily developed for use in automatic transmissions with electronically controlled converter lockup clutch, but also suitable for use as a universal ATF and power steering fluid, especially where Dexron III is the required specification, and is backwards compatible for Dexron II applications.



**LR003156** 1 litre  
**EPX SAE 80W-90 GL**  
 Ravenol Getriebeoel EPX SAE 80W-90 GL 5 is compatible with all brand-name transmission oils. In case of changing to Ravenol EPX SAE 80W-90 GL 5 lubrication is not necessary. It can be used in manual transmissions, axle drives, distributor and intermediate transmissions in vehicles and working machines.



**LR023288** 1 litre  
**DA3240** 4 litres  
**DA1345** 20 litres  
**ATF 8HP**  
 Ravenol ATF 8HP Fluid is an automatic transmission fluid (ATF), produced with a blend of hydrocrack oils & synthetic PAO together with special additives & inhibitors to enable smooth and efficient function of the latest ZF automatic transmissions. Ravenol ATF 8HP Fluid has been formulated specifically for the latest generation of 8-speed ZF auto transmissions and is coloured green for easy identification.



**DA1569** 300ml  
**DA2886** 1 litre  
**AWD-H Fluid**  
 A special high-performance transmission oil suitable for rear AWD coupling control units. Ravenol AWD-H Fluid should be changed every 37,500 miles in order to avoid damage to the powertrain.



More Ravenol Workshop Fluids Overleaf...



### Ravenol Workshop Consumables

#### Coolants



**DA6293** 1.5 litres  
**DA6294** 5 litres  
**Organic Technology Coolant Concentrate**  
 Ravenol Organic Technology Coolant Concentrate is an eco-friendly 1,2-Ethanediol (monoethylene glycol) based silicate, borate, nitrite and phosphate-free coolant for cooling circuits in combustion engines which provides maintenance-free corrosion and frost protection.



**DA1812** 1.5 litres  
**DA1821** 5 litres  
**Traditional Technology Coolant Concentrate**  
 An eco-friendly 1,2-Ethanediol (monoethylene glycol) based nitrite, amine and phosphate-free coolant for cooling circuits in combustion engines which provides maintenance-free corrosion and frost protection. The product is formulated as a long-term coolant based on a proven inhibitor development.

#### Power Steering



**STC50519** 1 litre  
**STC50519-20L** 20 litres  
**SSF Power Steering Fluid**  
 Ravenol SSF Fluid is a special hydraulic fluid formulated using the latest fully synthetic technology blended with special ashless additives. It is designed for use from -40°C to +100°C and is therefore recommended for the latest developments in the vehicle market.

#### Diesel System Cleaner



**DA4962** 300ml  
**Diesel System Cleaner**  
 A fuel additive for all diesel engines which cleans the fuel injection system and restores the full power of the engine, whilst increasing operational safety and improving fuel economy. It is a cleaning agent for electronically and mechanically controlled fuel injectors which allows for combustion with a low degree of soot and reduced particles whilst preventing rattling noises and rough idling.

#### Grease



**DA4960** 400g  
**DA4961** 5kgs  
**Multi-purpose Grease**  
 Ravenol Mehrzweckfett OML is a lithium based multi-purpose grease with oxidation and corrosion protective additives.



More information  
 on all these Ravenol products at  
[www.britpart.com/ravenol](http://www.britpart.com/ravenol)

#### Interior Cleaner



**DA1628** 400ml  
**Interior Cleaner**  
 Ravenol Cockpit-Spray is a highly effective care spray for the cleaning and maintenance of plastic, artificial and natural leather interior surfaces of all types of motor vehicles. Silicone-free formulation leaves a silky shine and protects treated surfaces from the effects of oxidative ageing, as well as helping to protect surfaces against the effects of intense sunlight such as fading and cracking. The anti-static properties ensure surfaces remain dust-free for longer and the product leaves a pleasant perfumed odour after use.



Photo by Martin Price



#### Oil Analysis Kit



**DA6358**  
 Lubetrend Analysis is the complete fluid analysis programme performed by the Number One oil condition monitoring laboratory in the UK with over 35 years of experience in monitoring all types of fluid lubricated and insulating oil systems; giving you the confidence to act. Regular checks on the condition of the oil can extend the life of both engine and transmission and help spot potential problems long before they materialise.

*Extend the life of both engine & transmission*

Our aim is to help you succeed in making the most of your vehicles and machinery through reducing unplanned downtime, extending oil drains and detecting potential future failure - before they happen. Essential not only for all aspects of motorsport - we'd recommend taking a sample after each event - but also recommended for your everyday transport as part of the annual service. The price includes the sample kit and the full analysis report. Postage to the laboratory is your responsibility.

Castrol Classic Oils & Greases

Castrol Classic Oils Workshop Consumables

DA6260	Classic XL 20W-50	1 gallon tin
DA6261	Classic XL 20W-50	1 litre tin
A conventional multi-grade engine oil of good all round performance for pre-1980 modern classic cars		
DA6264	EP140 Extreme Pressure API GL4	1 litre tin
Originally specified grade for Series steering boxes and relays		
DA6265	EP90 Extreme Pressure API GL4	1 litre tin
Extreme pressure multi-purpose gear oil for hypoid and non-hypoid applications		
DA6268	TQF	1 litre tin
Transmission fluid for automatic gearboxes, incorporating additives to provide wear, oxidation and corrosion resistance		
DA6269	Red Rubber Grease	500g pot
A special, rubber compatible grease for use on hydraulic brake and clutch components where hardening or swelling of rubber must be avoided. Useful in assembly of rubber components for brake, clutch and suspension units.		
DA1595	Water Pump Grease	500g pot
Hard consistency grease with high water resistance and excellent sealing properties. Also ideal for protecting brake pipes and fittings.		

Castrol Classic Oils Merchandise

DA6270	Castrol Tin Mug - Drink your tea in a nostalgic way with this large tin mug
Castrol Pouring Jugs - Use either to decorate your workshop or study or to accurately measure lubricant quantities shown in imperial measures in vehicle handbooks	
DA6271	Half pint
DA6272	Pint
DA6273	Quart (two pints)
DA6274	Baseball Cap - Smart green cap with embroidered Castrol logo. One-size fits all
DA6275	Window Service Sticker - Never forget to change your oil with this self-cling window sticker with Castrol logo on one side and Change Due boxes on the other. 3" diameter.

Castrol GTX

DA3542 NEW

5 litres  
Liquid Engineering from Castrol Classic Oils – *the original is back.*

Castrol GTX Classic 10W/40. A premium mineral oil suitable for vehicles from 1978 to 1993, extending the Classic range to cover younger and modern classics. Supplied in the traditional 5 litre tin with the iconic GTX stripe branding, GTX Classic will appeal to owners who want period correct oil with a period correct look:

- > Mineral 10W/40, suitable for vehicles 1978 to 1993 where a 10W/40 oil is specified
- > Period correct balanced additives for superior wear and corrosion protection, including ZDDP
- > Can be used in vehicles either with or without a catalytic converter
- > Suitable for both naturally aspirated and turbo-charged vehicles
- > Original handbook recommendation for many vehicles
- > Supplied in original style 5 litre can
- > API: SG

Oil is too small a word for it. Thin in cold, thick in heat; cooling, smoothing, protecting; pliant as liquid, tough as steel, always busy under gigantic stress. It is the result of over eighty years of single minded technical genius. More than just an oil, it is Castrol GTX – Liquid Engineering.



For more information on each product and images visit [www.britpart.com/castrol](http://www.britpart.com/castrol)

DA1595



Castrol Classic Oils,  
total care & protection  
for your classic vehicle.

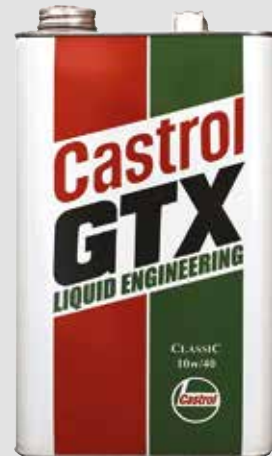

Workshop Fluids

Cataclean Cleaners



Photo by Tadas Indriliunas



**DA3325**  
**Cataclean Diesel**  
500ml

- > Improves fuel economy
- > Reduces emissions
- > Restores performance
- > Protects & maintains catalytic converter
- > Reduces risk of diesel particulate filter (DPF) clogging

Cataclean is a fuel and exhaust system cleaner. Cataclean will remove the harmful carbon build-up in the valves, injectors, oxygen sensors, EGR valve, and catalytic converter. Cataclean will also reduce the particulates in a DPF, preventing clogging. Cataclean can improve fuel economy, reduce emissions, restore performance and extend the life of engine/exhaust parts.



**DA3326**  
**Cataclean Petrol**  
500ml

- > Improves fuel economy
- > Reduces emissions
- > Restores performance
- > Protects & maintains catalytic converter

Cataclean is a fuel and exhaust system cleaner. Cataclean will remove the harmful carbon build-up in the valves, injectors, oxygen sensors, EGR valve and catalytic converter. Cataclean can improve fuel economy, reduce emissions, restore performance and extend the life of engine/exhaust parts.

- > Fuel Tank
- > Injectors
- > Catalytic Converter
- > Oxygen Sensors
- > EGR Valve
- > DPF
- > Combustion Chamber
- > Intake Valves

**DA3327**  
**Cataclean Work Shop**  
5 litres

- > Improves fuel economy
- > Reduces emissions
- > Restores performance
- > Protects & maintains catalytic converter
- > Reduces risk of petrol particulate filter (PPF) and diesel particulate filter (DPF) clogging

Cataclean 5 litre is a bulk product for the automotive workshop. Cataclean is a fuel and exhaust system cleaner. Cataclean will remove the harmful carbon build-up in the valves, injectors, oxygen sensors, EGR valve, and catalytic converter. Cataclean will also reduce the particulates in a PPF, preventing clogging. Cataclean can improve fuel economy, reduce emissions, restore performance and extend the life of engine/exhaust parts.



The Complete Fuel & Exhaust System Cleaner



### AdBlue



All new Euro 6 engines now have to have a diesel additive to reduce the emissions. The AdBlue liquid - called Diesel Exhaust System does this. Newer Land Rovers are using this more additive than expected, so there is a need for people to replace the fluid used. If the fluid runs out, the engine stops and won't restart without a visit to the Land Rover dealership.

#### DA1622

- 10 litre drum with spout
- > Conforms to ISO22241 as specified by all vehicle manufacturers. Every batch is independently tested before release
- > Suitable for diesel vehicles & machinery fitted with SCR emission removal systems. If in doubt, refer to operating manual
- > 32.5% solution of pure urea in demineralised water
- > Reduces Nitrous Oxide (NOx) emissions
- > Ready to use

#### LR072258G

4 x 1.89 litre (1/2 gallon) bottles  
Previously this has only been available through Land Rover, now Britpart have the OE supplier product in stock



### DPF Cleaner

#### DA6859

325ml

**Wynn's Diesel Particulate Filter Cleaner**  
Chemical treatment for diesel engines that reduces soot emissions, cleans and regenerates the particulate filter.

- > Reduces soot formation during the fuel combustion cycle.
- > Clears and regenerates blocked soot filters without dismantling.
- > Complete burn-off of soot particles during driving.
- > Avoids frequent maintenance costs related to the manual regeneration of the blocked soot filter
- > Optimizes combustion and lowers fuel consumption
- > Especially suited for city driving cycles
- > Can be used in combination with built-in regeneration systems
- > Ultra-fast result!

### Dr. Tranny® Instant Shudder Fixx™

#### DA6809

2fl oz (59.2ml)

Packaged in a uniquely engineered two ounce application tube Dr. Tranny® Instant Shudder Fixx™ is compatible with conventional or synthetic automatic transmission fluids. This formulation of friction modifiers made of synthetics and synthetic esters is concentrated five times.

- > A concentrated friction modifier formulated specifically for instantly eliminating torque converter lock-up shudder
- > Provides 4x's less wear than regular ATF
- > The original shudder fix
- > Compatible with conventional and synthetic ATFs
- > Commonly used as a diagnostic tool to determine if a problem is fluid related or a more mechanical fix is required



### Brake Cleaner

#### STC8972

TRW Brake Cleaner

500ml aerosol

- > Cleans & degreases brake and clutch parts
- > Evaporates quickly
- > Simplifies dismantling and assembly
- > Removes dust, oil, grease & brake fluid
- > Sprays from any angle

#### STC50544LR

Land Rover

400ml

General purpose/brake cleaner



### Trade Tack Stab

#### DA6348

Super Bond Spray Adhesive

250ml aerosol

- > High strength
- > Variable spray
- > Quick
- > Clean
- > High tack/long tack
- > Very fast set

Ideal for bonding and laminating of polyurethane foam, polystyrene foam, fibres, fabrics & felts etc to themselves.



### Lead Replacement Petrol Additives



#### DA6267

#### DA6267

Classic Valvemaster™ Plus

250ml bottle - treats 250 litres

Valvemaster Plus with its unique phosphorus formula provides the ultimate protection against valve seat recession. Valvemaster Plus contains Octimise-Plus friction modifier for increased acceleration and economy, increasing acceleration by up to 3% and increasing economy by up to 2%. It also contains Etha-Guard ethanol stabiliser, enabling the use of Ethanol E5 and E10 petrol, preventing acidity, protecting against corrosion and keeping the fuel system clean. Valvemaster Plus can be used with 95, 97, 98, 99 or higher octane rated petrol containing E5 or E10 ethanol.

- > The best protection after lead against valve seat recession
- > Increases fuel economy by up to 2%
- > Protects your engine under all driving conditions
- > Keeps fuel systems clean
- > Protects against corrosion
- > Increases acceleration by up to 3%

#### DA6266

Classic Valvemaster™

250ml bottle - treats 250 litres

Valvemaster with its unique phosphorus formula protects against valve seat recession under all driving conditions. Containing Etha-Guard ethanol stabiliser that protects and enables use of ethanol E5 and E10 petrol in classic cars and pre-1996 petrol vehicles. For use with 95, 97, 98, 99, or higher octane ethanol E5 and E10 petrol. Valvemaster is the recommended solution for vehicles requiring valve seat protection.

- > The best protection after lead against valve seat recession
- > Protects your engine under all driving conditions
- > Keeps fuel systems clean
- > Protects against corrosion

### Coolants/Anti-freeze

#### STC50529

#### Morris

Extended life coolant concentrate

STC50529 1 litre

STC50530 5 litres

STC50530-20L 20 litres

#### Havoline

LR181438G NEW 1 litre

#### Land Rover

Anti-freeze/coolant

PDA500300LR 1 litre

Extended life anti-freeze/coolant

STC50529LR 1 litre



### Brake Fluid

#### LR052652

500ml

#### LR052653G

1 litre



### Swivel Housing Grease

#### STC3435

370g bottle

#### STC3435S

370g sachet

- > Formulated for all Land Rover models with ball type swivel housings
- > Lubricates swivel pins and housing seals, protects spheres
- > A semi-fluid grease designed to withstand shock loading in oscillating joints
- > Reinforced with solid lubricants, highly resistant to water and salt corrosion
- > Better lubrication while driving, less leaks while standing
- > One shot gives 'filled for life' protection



### Bearing Grease

#### DA2391

10 x 20ml

sachets of bearing

grease



Friction Modifier



**DA6296**  
850ml  
Oil additive  
Friction modifier

CV Joint Grease



**DA2833**  
CV Joint Grease  
90g sachet

Hand Sanitiser Gel



**DA9992**  
> 50ml  
> Alcohol free  
> Kind to hands  
> Kills 99.999% of bacteria & enveloped viruses  
> Certified to BS EN 14476:2013 + A2:2019 7 BS EN 1276  
> Aloe vera with cucumber fragrance  
> Made in UK

Air-con Compressor Oil



**DA3265 NEW**  
500ml  
Mahle PAO AA1 - PLUS UV air con compressor lubricant for air conditioning systems in vehicles with conventional petrol or diesel engines.

Miscellaneous Workshop Fluids



**LR023889LR**

**STC50519LR**

**STC4672LR**  
Screen wash  
Land Rover  
250ml  
**STC9155LR**  
Specialised lubricant  
Land Rover  
250ml  
**STC50519LR**  
Power assisted steering fluid/ACE  
Land Rover  
1 litre

**STC9155LR**

**LR023889LR**  
Leather & vinyl cleaner  
Contents - 1 x 150ml leather protection cream; 1 x 150ml leather soft cleaner & 1 x sponge and cloth

TetraBOOST

**DA2910**  
**TetraBOOST E-Guard 15**  
945ml bottle



**TetraBOOST**

TetraBOOST is the only truly effective answer for collectors and dealers alike. Low mileage vehicle use may not justify an expensive engine rebuild. It may not be possible to fit specially hardened valve seats, or the new hardened valve seats have split the block due to differential expansion during warm up.

Specifically formulated for older engines and it enables you to tour, race or tow without fear of damage caused by inadequate valve seat protection, pre-ignition or low octane fuel. TetraBOOST also slows the burn rate of modern fuels to a level more suitable for older engines, resulting in easier starting, smoother and cooler running as well as giving greater economy.

TetraBOOST is not a substitute but is the only additive that makes real leaded fuel from the unleaded pump. Suitable for all road and track applications, TetraBOOST provides all the benefits of BS4040 (or greater) leaded pump fuel, without the extra cost and inconvenience of finding the diminishing number of garages that still stock leaded pump fuel or resorting to race fuel. Even in cars fitted with hardened valve seats, TetraBOOST improves performance and reduces valve stem and guide wear. It slows fuel-burn rate - giving improved combustion, improves throttle response and gives smoother pick-up and cooler running. When mixed with higher octane unleaded fuel, such as Shell V-Power, TetraBOOST can easily exceed BS4040 standards, with its unique ability to make 5-star 100 octane or much higher levels of fuel. Up to 106 octane fuel can be made if required.

**What's in TetraBOOST?**

TetraBOOST is a solution of tetraethyl lead in aromatic hydrocarbons, which together with the necessary chemical 'scrubbers' makes genuine 4 & 5-star petrol, with higher octanes approaching AVGAS levels available if required. Remember that TetraBOOST is suitable for both road and race purposes. A measured dose of TetraBOOST is merely added to the tank, prior to filling up with premium or super unleaded pump fuel to the correct concentration.

TetraBOOST is the only truly effective answer for collectors and dealers alike. Low mileage vehicle use may not justify an expensive engine rebuild. It may not be possible to fit specially hardened valve seats, or the new hardened valve seats have split the block due to differential expansion during warm up.



**DA2912**  
**TetraBOOST E-Guard Road**  
12 x 50ml bottles

TetraBOOST E-Guard Road is a potassium-based lead replacement, octane booster and ethanol corrosion inhibitor. Designed for cars without hardened valve seats, to give protection from problems resulting from modern ethanolised petrol.  
> One 50ml bottle for up to 50 litres of fuel.  
> Protects against ethanol induced corrosion  
> Inhibits valve seat recession  
> Raises octane by up to 2 points



**DA2911**  
**TetraBOOST Fuel Life Extender**  
12 x 50ml bottles

TetraBOOST Fuel Life Extender addresses the increasingly common problem of today's petrol 'going off', which causes difficult starting after a period of storage.  
> One 50ml bottle for up to 50 litres of petrol  
> Extends petrol storage life  
> Slowly disperses existing sludge  
> Ideal for winter storage

Lubegard® Gear Fluid Supplement

**DA1905** 237ml bottle  
Lubegard® Gear Fluid Supplement is designed for use in all manual transmissions, transaxles and final drives that require gear oil. Lubegard® contains LXE®, (liquid wax esters) and their derivatives, a blend of high grade petroleum oil, synthetic base oils and a complete anti-wear formula. Lubegard® is designed to provide high temperature stability to prevent harmful deposits on synchros and gears. For use in all manual transmissions, manual transaxles and final drives that require gear oil.  
> Reduces drive train power loss  
> Lowers temperature and extends fluid life  
> Improves heat transfer from the fluid to the case wall and out the gear box  
> Improves all cold weather stiffness  
> Improves all manual & synchromesh transmission shifting characteristics  
> Reduces tooth drag and absorbs shock loads, thus improves the life of all gear units  
> Lowers friction on bearings and gears with high wiping stresses, especially hypoid gears  
> Minimizes oxidation and varnish deposits  
> Suppresses lubricant foaming  
> Safe for new MTF Fluids  
> Increases power transfer, reduces energy consumption  
> Decreases equipment operating and maintenance costs

Lubegard® Gear Fluid Supplement Provides:

- More Power**
- > Reduces back-lash frictional (i.e. tooth) drag in differentials allowing more horsepower to the wheels
  - > Lower operating temperatures
  - > Reduces rolling and sliding friction in the gears
  - > Reduces friction between the bearing rolling elements and their separators
  - > Improves heat transfer from the fluid to the case wall and out of the gear box
- Longer Equipment Life**
- > Reduces wear on gears and rolling elements
  - > Lowers operating temperature and prolongs fluid life
  - > Enhances the stability of the gear oil
  - > Contains no shear-sensitive viscosity components
  - > Will not cause sludge or varnish
  - > Contains no harmful solid lubricants or corrosive chemical enhancers
- Economy**
- > Ratio used is at 3 fluid oz. to a quart = 1 part in 10
  - > Saves on downtime by extending gear fluid changes



Duxback

**DA1649**  
**Duxback One Car Kit**  
Duxback is a revolutionary glass treatment that creates a 'hydrophobic' effect on automotive glass. Originally developed for aviation and applied to Boeing cockpit glass, a Duxback treatment greatly improves safety when driving in pouring rain especially at night. When driving over 40mph, rain water will be blown straight off the glass, no need for wipers! In wintertime, ice will either not stick to the glass or will be much easier to remove. Research has shown that visibility is improved by 35% when driving in pouring rain. Furthermore a driver's ability to identify a small object when driving in foul conditions is improved by 25%. A 25% improvement in reaction time is 58 feet at 40mph. Enough to save a life! Duxback is a certified product approved by TÜV Thüringen  
> 35% Improved visibility  
> 25% Improved reaction times  
> 58ft Better reaction distance



**35%**  
Improved  
Visibility



WITH DUXBACK

WITHOUT DUXBACK



### Evans Waterless Coolants & Prep Fluid

#### Power Cool 180° & Classic Cool 180°

##### Benefits Over Water-based Coolants

##### Eliminates Overheating

Evans Waterless Coolants have a boiling point above 180°C and will not vaporise, thus eliminating overheating, boil-over and after-boil.

##### Reduces Pressure

Evans Waterless Coolants generate very low vapour pressures reducing strain on engine hoses and cooling system components.

##### Prevents Corrosion

Water promotes corrosion via oxidation and electrolysis - Evans Waterless Coolants contain no oxygen and are virtually non-conductive effectively preventing corrosion.

##### Maximise BHP

Evans Waterless Coolants eliminate pre-ignition and detonation caused by overheating - thus increasing combustion efficiency and delivering more power.

##### Stops Erosion

Evans Waterless Coolants stop cavitation and eliminate liner and cooling pump erosion.

##### Freeze Protection

Evans Waterless Coolants freeze below -40°C

##### Non-Toxic

Evans Waterless Coolants are proven to be non-toxic. Standard anti-freeze is toxic and known to kill pets.

**High  
Performance  
Synthetic  
Formula**



**Advanced  
Cooling for  
Classic Cars**



#### Power Cool 180°

DA3434	NEW	25 litres
DA3435	NEW	5 litres
DA3436	NEW	2 litres

#### Description

Waterless engine coolant for modern & performance engines.

#### Application

For use in modern & performance car engines and associated cooling systems fabricated from aluminium, aluminium alloys, steel and copper components.

#### Typical Characteristics

Physical state : Low viscosity synthetic liquid

Boiling point : Above 180°C

Freezing point : Below -40°C

Colour : Red clear

Odour : Almost odourless

Taste : Slightly sweet, non-toxic but not recommended for human consumption

#### 4-Life Durability

Evans Waterless Engine Coolants have been proven to last >20 years and a million miles in service without the need for replacement.

#### ASTM & ISO Standards

Evans in association with ASTM committee D15.22 have developed a specific range of standards for waterless engine coolants. All Evans Coolants are manufactured in accordance with certified ISO procedural standards.

#### Classic Cool 180°

DA3437	NEW	25 litres
DA3438	NEW	5 litres
DA3439	NEW	2 litres

#### Description

Waterless engine coolant for classic cars.

#### Application

For use in classic car engines\* primarily fabricated from cast iron with carbon steel, copper & aluminium components. \*Not suitable for engines using thermo-syphon cooling systems

#### Typical Characteristics

Physical state : Low viscosity synthetic liquid

Boiling point : Above 180°C

Freezing point : Below -40°C

Colour : Green clear

Odour : Almost odourless

Taste : Slightly sweet, non-toxic but not recommended for human consumption

#### 4-Life Durability

Evans Waterless Engine Coolants have been proven to last >20 years and a million miles in service without the need for replacement.

#### ASTM & ISO Standards

Evans in association with ASTM committee D15.22 have developed a specific range of standards for waterless engine coolants. All Evans Coolants are manufactured in accordance with certified ISO procedural standards.



#### Evans Prep Fluid

##### Benefits

##### Flushing

Evans Prep Fluid is formulated to hygroscopically absorb water whilst flushing loose dirt and scale from the cooling system prior to filling with Evans Waterless Coolant.

##### No Water

Prep Fluid contains no water eliminating the problems caused by water based coolants, increasing reliability and extending engine life.

##### Non-Toxic

Prep Fluid has been tested and certified as non-toxic by an EPA approved laboratory. It is biodegradable and will not bio-accumulate.



DA3440	NEW	25 litres
DA3441	NEW	5 litres
DA3442	NEW	2 litres

#### Description

Waterless engine flush for all engine types

#### Application

Designed as a preparatory fluid to help remove residual water from engine cooling systems as part of the fluid conversion process.

#### Typical Characteristics

Physical state : Low viscosity synthetic liquid

Boiling point : Above 180°C

Freezing point : Below -40°C

Colour : Clear

Odour : Almost odourless

Taste : Slightly sweet, non-toxic but not recommended for human consumption

#### ASTM & ISO Standards

Evans in association with ASTM committee D15.22 have developed a specific range of standards for waterless engine coolants. All Evans Coolants are manufactured in accordance with certified ISO procedural standards.

### Degreasing Fluid

#### DA3544 NEW

#### Lydian Degreasing Fluid

Lydian Degreaser is a ready for use, blue coloured emulsifiable fluid, manufactured from a mixture of hydrocarbon solvents and a non-ionic detergent. This powerful degreasing formulation acts by splitting the bond between solid dirt and oily matter, so that the surface can then be washed clean with water. It has an extremely effective cleaning action on all surfaces, even at low ambient temperature. Lydian is non-caustic, it will not corrode metal parts and washes away cleanly without leaving any harmful or corrosive residues on the surfaces.

#### Features

- > Highly effective cleaning action
- > Easy to remove with water
- > Non-caustic
- > Safe on metal parts



#### Applications

Recommended for removal of oil grease and dirt from metal, paintwork and concrete. Typical uses include cleaning used engines prior to overhaul, removing build-up on pipes and steelworks, cleaning concrete and brickwork. Many uses can be found in factories, yards and compounds, where oil and grease build up is a problem, or perhaps even dangerous for vehicles and pedestrians.

Lydian is always more effective if it can be allowed to soak into the dirt and surfaces for several hours, or even overnight before hosing off. Lydian is easily applied by spraying, brush or dipping. Do not use Lydian on Tarmac as it will soften this type of surfacing. It is also not advisable to use Lydian in parts washers with plastic components as its aggressive nature may harm them. Under no circumstances should this product, neat or diluted, be disposed of by putting into drains, soil or water courses.



Raptor Aerosols



Raptor 2K Multi-Use Protective Coating

DA6644	Black	1 x 400ml aerosol
DA6642	Black	6 x 400ml aerosols
DA6665	White	1 x 400ml aerosol

Use 2K Raptor aerosols to touch up your Land Rover's lower panels, wheel arches, bumpers, roll bars and many other vulnerable areas.

- > Superior durability
- > UV Protection
- > Chemical and abrasion resistant
- > Water resistant finish keeps moisture out, protecting against rust and corrosion
- > Use on multiple substrates from original paint, metals, rigid plastic, fibreglass, polyester body fillers, wood and more
- > Ideal for small jobs and bed liner repairs
- > Easy no mess, no clean-up application vs traditional spray equipment
- > Easy to activate
- > Create a range of textured 'gun' finishes from one can
- > Patented delivery system

Achieve different textures with your aerosol

- > Flat rippled
- > Matt rough
- > Coarse ripple
- > Smooth fine silky

**Easy to activate using the valve on the base. No measuring required.**



Raptor 1K Multi-Use Protective 1k Aerosol

DA6650 Black 1 x 450ml aerosol  
Raptor multi-use protective coating protects a variety of surfaces from impact, scratches, corrosion and water damage. Ideal for vehicles, trailers, railings, stairs, metal furniture and more.

Its 1K formulation gives a durable, abrasion resistant finish with excellent adhesion to metal, aluminium, fibreglass, plastic and wood.

Clog free nozzle and easy to use, it dries to form an attractive, textured finish that resists fading from the sun.

- > Textured finish
- > Durable and gives good corrosion resistance
- > Excellent adhesion to prepared metal, aluminium, fibreglass, plastic and wood
- > Ideal for both the automotive and DIY market
- > No need for an air-fed mask or spray booth

Ready to go Raptor

3 x Tougher Than Other 1K Aerosols!



See it in use at

[www.britpart.com/DA6650](http://www.britpart.com/DA6650)

Touch Up Paint Pens



Exclusive to Britpart in the UK



- > TUPP single stage paint pen is ergonomic, light and easy to use
- > It allows quick, one-step repairs of small scratches and nicks that may appear on any painted surface
- > It will meet the highest colour matching expectations
- > The patented valve mechanism and gravity action of the paint pen will give you an even flow of all components assuring the same particularities and brightness of the original finish
- > An edged polyester fibre tip allows accuracy and can be removed to be cleaned or replaced
- > The paint pen has a closed opaque container preventing accidental spills, hardening of the paint and colour change due to light exposure before the application

**The best you can get without repainting!**

**The Pen** - Paint is held in a barrel and automatically dispensed through a fine felt tip, providing the user unparalleled control over their painting instrument.

**The Paint** - High quality urethane paint is used which is the same as your vehicles manufacturer. The paint provides the user with a much closer colour match than other companies which primarily use lacquer paints.

**The Results** - The best you can get without refinishing the damaged areas. More details and FAQs can be found at [www.britpart.com/paintpens](http://www.britpart.com/paintpens)

Part Number	Colour	Code(s)
DA3772 NEW	AA Yellow	584
DA6217	Adriatic Blue	731
DA6461	Aintree Green	866 (HGY)
DA6237	Alaska White	909
DA6454	Aleutian Silver	835 (MMC)
DA6202	Alpine White	456 (NUC)
DA6212	Alveston Red	696
DA3750 NEW	Amazon Green	752
DA3751 NEW	Ammonite Grey	1AB
DA6226	Arctic Frost	962
DA3752 NEW	Aruba Gold	1AJ
DA6476	Aruba Metallic	995 (GAT)
DA6223	Atacama Sand	916
DA6233	Atlantis Blue	632 (JYW)
DA3753 NEW	Autobiography Grey	669
DA3754 NEW	Autobiography Red	661
DA3755 NEW	Aztec Brown	719
DA3756 NEW	Bali Blue	823
DA6468	Baltic Blue	912 (JEB)
DA6457	Barolo Black	861 (PEH)
DA6465	Barossa Pearl	871 (KEB)
DA6230	Belize Green	756
DA6200	Beluga Black	416 (PUE)
DA3753 NEW	Bering Grey	669
DA6236	Biarritz Blue	965
DA3757 NEW	Biscay Blue	913
DA3758 NEW	Black Cherry	700
DA6245	Blenheim Silver	642
DA3767 NEW	Blue Steel	698
DA6214	Bonatti Grey	659
DA3759 NEW	Bordeaux Red	750
DA6243	Borrego Yellow	757 (FUQ)
DA3760 NEW	Bournville	822
DA6203	British Racing Green	617
DA6220	Buckingham Blue	588 (796)
DA6221	Cairns Blue	849
DA6229	Caledonia Blue	507 (JUT)
DA6474	Causeway Grey	950 (LNL)
DA6472	Chablis Green	945 (MMD)
DA3761 NEW	Cayman Orange	646
DA6210	Chawton White	603
DA6471	Chile Metallic	944 (CAS)
DA6244	Cobar Blue	624 (JAV)
DA6481	Colima Lime	829 (HAQ)
DA6467	Corris Grey	873 (LKH)
DA6204	Epsom Green	961
DA6478	Estoril Blue	998 (JAE)

DA6463	Firenze Red	868 (CAH)
DA6462	Fuji White	867 (NDH)
DA3762 NEW	Galway Green	821
DA6218	Giverny Green	734
DA6460	Havana	865 (AAN)
DA3763 NEW	Helsinki Blue	848
DA6232	Icelandic Blue Mica	621 (JEL)
DA6458	Indus Silver	863 (MEN)
DA6242	Ipanema Sand	GAQ
DA3764 NEW	Iris Mauve	724
DA3765 NEW	Izmir Blue	920
DA6211	Java Black	697
DA3766 NEW	Juniper Blue	709
DA6477	Kaikoura Stone	997 (BAG)
DA3767	Karoo Blue	698
DA6239	Kent Green	647
DA8044	Keswick Green	799 (HFU)
DA6231	Kinver Sand	609 (EAB)
DA3768 NEW	Kosrae Green	862
DA3769 NEW	Lago Grey	911
DA6469	Loire Blue	942 (JBM)
DA6241	Lucerne Green	966
DA3770 NEW	Lugano Teal	963
DA6464	Luxor	869 (GAA)
DA6456	Mariana Black	860 (PEL)
DA6480	Marmaris Teal	826 (JCK)
DA6459	Mauritius Blue	864 (JYN)
DA6219	Maya Gold	846
DA6475	Montalcino Red	952 (CAX)
DA6483	Nara Bronze	825 (AAJ)
DA6228	Narvik Black	921
DA3771 NEW	Nazca Sand	919
DA6240	Niagara Grey	574
DA6473	Orkney Grey	949 (KJZ)
DA6213	Oslo Blue	644
DA6205	Oxford Blue	602
DA6201	Portofino Red	390 (CUF)
DA6227	Rimini Red	889
DA6206	Rioja Red	601 (CAQ)
DA3754 NEW	Roma	661
DA6207	Rutland Red	607
DA3772 NEW	Sahara Yellow	584
DA6259	Santorini Black	820
DA6470	Scotia Grey	943 (LAZ)
DA6482	Siberian Silver	834 (MBP)
DA3773 NEW	Siljan Black	925
DA6234	Silver Sparkle	MNH
DA3774 NEW	Stormer Orange	932

DA6235	Stornoway Grey	907 (LEL)
DA3775 NEW	Sumatra Black	797
DA3776 NEW	Sunstone Copper	1BH
DA6455	Tamar Blue	817 (JMC)
DA3777 NEW	Tambora Flame	810
DA6238	Tangiers Orange	761
DA3778 NEW	Tobago Spice	800
DA6222	Tonga Green	904
DA6224	Vesuvius Orange	811
DA6215	Vienna Green	751
DA3779 NEW	Whistler White	922
DA6208	White Gold	618
DA6209	Woodcote Green	623 (HPE)
DA6479	Yulong White	2201 (NAK)
DA6216	Zambezi Silver	737
DA6466	Zanzibar Brown	872 (EAR)
DA6225	Zermatt Silver	798

Touch Up Paint Kits & Aerosols



Aerosol - 150ml	
LR005710LR NEW	Alaska White
STC4597VALR NEW	Bonatti Grey
STC3822VALR NEW	Caledonian Blue
STC3828VALR NEW	Chawton White metallic
STC1774VALR NEW	Epsom Green
LR005714LR NEW	Java Black
RTC6401VALR	Windjammer Blue
RTC4041VALR NEW	Pastel Green
VEP501740HFYLR NEW	Tonga Green
Touch Up Kit - Paint stick - 12ml & Clear lacquer - 12ml	
RTC6870VTLR	Alpine White
STC4235VTLR	Blenheim Silver
STC1774VTLR	Epsom Green
VPLDC0004NERLR NEW	Fuji/Polaris White
VEP501730HFULR NEW	Keswick Green
STC4596VTLR	Oslo Blue
STC2828VTLR	Rioja Red





For full product details and a video to see how easy it is to use visit

[www.britpart.com/raptor](http://www.britpart.com/raptor)



One half of this Discovery 1 corner bumper is a very tired looking, tatty and weather beaten bit of plastic. The other half is transformed with a coating of Raptor and it will stay like this as Raptor is UV resistant.



DA6382



DA6497



DA6370



DA6371

# RAPTOR

**TOUGH & TINTABLE** protective coating

Raptor is a highly durable protective coating that ensures protection against mechanical damage, fuels, hydraulic oils, rust, corrosion, salt water, damp, extreme temperatures and off-road muddy good fun.

- |                     |                |
|---------------------|----------------|
| <b>Surfaces*</b>    | <b>Usage</b>   |
| > Painted surfaces  | > Automotive   |
| > Aluminium         | > Off-road     |
| > Steel             | > Marine       |
| > Bare metal        | > Commercial   |
| > GRP               | > Industrial   |
| > Galvanised        | > Agricultural |
| > Plastics          |                |
| > Wood              |                |
| > Polyester fillers |                |
| > Glass             |                |
| > SMC               |                |

\*Some substrates require additional surface preparation before applying Raptor.



**Customisable**

Raptor is available in black and tintable versions. The tintable version can be altered to suit the colour of your vehicle by adding a small amount of automotive solvent paint. Raptor can be applied as a smooth finish through to a very coarse finish.

**Features & Benefits**

- > Easy to use: simply FILL - SHAKE - SHOOT®
- > Easy to clean
- > Provides excellent UV protection
- > Waterproof - provides a water tight seal, keeping water out and protects new surfaces against rust
- > Sound deadener (reduces noise and vibrations)
- > Protects against rust, corrosion, salt, damp and extreme temperatures
- > High resistance to everyday and off-road use
- > Abrasion and stain resistant
- > Dries rapidly, is flexible
- > Provides excellent adhesion
- > No need to wax after application

**Achieve Different Textures**

- > Flat rippled
- > Matt rough
- > Coarse ripple
- > Smooth fine silky

**Application Areas**

- > Chequer plate and grills
- > Loading area
- > Underbody protection
- > Bumpers and bull bars
- > Sills, side rails and steps
- > Wheels and wheel arches
- > Part and full vehicle overspray
- > And much more...

**Application Methods**

- > Raptor application gun
- > Roller
- > Brush



Protect your Land Rover with Raptor

**Black Finish**

- DA6382** Raptor 4 litre kit - black  
4 x 750ml Raptor & 1 x 1 litre hardener
- DA6497** Raptor 1 litre kit - black  
1 x 750ml Raptor & 1 x 250ml hardener
- DA6370** 1 x 5 litres of black Raptor

**White Finish**

- DA6649** Raptor 4 litre kit - white  
4 x 750ml Raptor & 1 x 1 litre hardener

**Tintable Finish**

- DA6384** Raptor 4 litre kit - tintable finish  
4 x 750ml Raptor & 1 x 1 litre hardener
- DA6498** Raptor 1 litre kit - tintable finish  
1 x 750ml Raptor & 1 x 250ml hardener
- DA6436** 1 x 5 litres of tintable Raptor

**Hardener**

- DA6371** 1 x 5 litres of Raptor hardener



**Raptor Protective Coating**



DA6386



DA6447



DA6617



DA6391



DA6393



DA6394



DA6394



DA6484



DA6653



DA6396



DA6397



DA6398



**Raptor Colour Pouches**  
**DA3332 NEW** Beige RAL 1001  
**DA3333 NEW** Olive Green RAL 6003  
**DA3334 NEW** Orange RAL 2008  
 45ml Pouch. Raptor Colour Pouches are a highly concentrated tint for use with Raptor Tintable Protective Coating. Mix Raptor Colour Pouches with Raptor Tintable Base (they can fit in the bottle) to give a rich, UV resistant colour that won't fade even after years in the sun. Available in three colours, users can choose either a single colour or use different colours to create their own multi-coloured, custom look. Simple to use. Add one Colour Pouch to Tintable Raptor bottle and hardener. Shake the bottle for 2 minutes to make sure the colour is thoroughly mixed. Ready to apply.

**DA6386 Schutz Application Gun**  
 Specially constructed for the application of Raptor. Screws directly onto plastic bottle.  
**DA6447 Professional Automotive Gravity Fed Spray Gun**  
 1.7 tip with excellent transfer efficiency.  
**DA6617 Vari-nozzle Spray Gun**  
 Delivering a professional, consistent finish with the ability to customise your texture. Locking nozzle for consistency and repeatability.  
**Degreaser Slow**  
**DA6390** 1 litre tin  
**DA6391** 5 litre tin  
 Anti-static and anti-silicone panel wipe. Slow evaporation ideal for larger panel repairs. Aggressive degreasing action removes contaminants including silicones. Carefully formulated to avoid any attack on existing paint films.  
**DA6393** 450ml aerosol  
**ACID#8™: Acid Etch Primer**  
 Promotes paint adhesion to difficult substrates such as galvanised steel & aluminium.  
**DA6394** 450ml aerosol  
**GRIP#4™: Universal Adhesion Promoter**  
 Ready for use universal adhesion promoter for paints, adhesives and sealants. Ideal for difficult to reach areas such as around door handles and sills. Replaces the need for abrasion and prevents lifting.  
**DA3344 NEW** 450ml aerosol  
**WIPE #6 Solvent-Based Degreaser**  
 An anti-static, anti-silicone degreaser that removes contaminants including wax, grease and silicones. Fast evaporating for localised repairs. Formulated to avoid attack on existing paint film. Can be used on bare metal and existing paint surfaces.  
**DA6484** 200g sachet

**DA6653 Tray & Rollers**  
 Specifically designed to work with Raptor and to provide a great textured finish. 1 x tray & 2 x 4" rollers.  
**DA6396** 140m roll with 350 sheets  
**Panel Wipe Cloths**  
 White wipe that leaves the surface clean, completely grease & fibre-free. Convenient centre-feed box dispenser.  
**DA6397** 25 qty  
**Mixing Cups**  
 Clear plastic 1,300ml mixing cups  
**DA6398** 100 qty  
**Wooden Mixing Spatulas**



**Raptor Traction**  
 Slip resistant additive. 1 sachet needed for 1 litre Raptor. BSI Kitemarked.



**Raptor Anti-corrosion Epoxy Primer**

Raptor Anti-Corrosive Epoxy Primer is a 2K high performance primer specifically designed to be used under Raptor Protective Coating to further extend the protective and anti-corrosive properties of Raptor. The advanced resin technology in Raptor Anti-Corrosive Epoxy Primer improves adhesion to bare metal and most other prepared surfaces. It contains a blend of anti-corrosive additives to inhibit rust and corrosion.  
**DA6615** 1 litre  
**DA6616** 5 litres  
**Available in a Convenient Aerosol**  
**DA6647** 1 x 400ml aerosol - Beige  
 > Easy and convenient - activate using the valve on base  
 > No need for spray equipment  
 > Ideal for both consumers & professionals

DA6615



DA6647



### Dinitrol Products

These rustproofing kits are designed for those who don't have access to a compressor or air supply.

#### DA1985

##### Rust Proofing Aerosol Kit - Large Car

- 7 x Dinitrol 3125 Cavity Wax - 500ml aerosol
- 10 x Dinitrol 4941 Black Underbody Wax - 500ml aerosol
- 1 x Dinitrol RC900 Rust Converter - 400ml aerosol
- 2 x 600mm Extended nozzle for aerosols
- 50 x 10mm Black tapered plastic plugs
- 1 x Aerosol application trigger attachment

#### DA1986

##### Rust Proofing Aerosol Kit - Land Rover

- 7 x Dinitrol 3125 Cavity Wax - 500ml aerosol
- 5 x Dinitrol 445 Black Stone Chip - 500ml aerosol
- 5 x Dinitrol 4941 Black Underbody Wax - 500ml aerosol
- 1 x Dinitrol RC900 Rust Converter - 400ml aerosol
- 2 x 600mm Extended nozzle for aerosols
- 50 x 10mm Black tapered plastic plugs
- 1 x Aerosol application trigger attachment

#### DA1989

##### Rust Proofing Aerosol Kit - New Vehicle

- 7 x Dinitrol 77B Brown Cavity Wax - 500ml aerosol
- 5 x Dinitrol 445 Black Stone Chip - 500ml aerosol
- 5 x Dinitrol 4941 Black Underbody Wax - 500ml aerosol
- 1 x 600mm Extended nozzle for aerosols
- 50 x 10mm Black tapered plastic plugs
- 1 x Aerosol application trigger attachment

These rustproofing kits are designed for those who have access to a compressor or air supply and includes an undercoating gun for easy application.

#### DA1987

##### Rust Proofing Litres kit - Large Car

- 4 x Dinitrol 3125 Liquid Cavity Wax - 1ltr bottle
- 6 x Dinitrol 4941 Black Underbody Protect 1ltr bottle
- 1 x Dinitrol RC900 Rust Converter - 400ml aerosol
- 1 x Shutz Gun
- 50 x 10mm Black tapered plastic plugs
- 1 x 600mm Extended nozzle for aerosols

#### DA1988

##### Rust Proofing Litres Kit - Land Rover

- 4 x Dinitrol 3125 Liquid Cavity Wax - 1ltr bottle
- 3 x Dinitrol 445 Black Stone Chip - 1ltr bottle
- 3 x Dinitrol 4941 Black Underbody Protect - 1ltr bottle
- 1 x Dinitrol RC900 Rust Converter - 400ml aerosol
- 1 x Shutz Gun
- 50 x 10mm Black tapered plastic plugs
- 1 x 600mm Extended nozzle for aerosols

#### DA1990

##### Rust Proofing Litres Kit - New Vehicles

- 4 x Dinitrol 3654 ML4 Cavity Wax - 1ltr bottle
- 3 x Dinitrol 445 Black Stone Chip - 1ltr bottle
- 3 x Dinitrol 4941 Black Underbody Protect - 1ltr bottle
- 1 x Shutz Gun
- 50 x 10mm Black tapered plastic plugs



For much more information on each of the Dinitrol products in each kit and the technical data sheets -

[www.britpart.com/dinitrol](http://www.britpart.com/dinitrol)



The Dinitrol DIY Rustproofing Kits are perfect for protecting your own Land Rover. The rustproofing treatments can be applied in 6 easy steps.

#### Dinitrol 77B

DA1984 500ml aerosol

DA1982 1 litre canister

Dinitrol 77B is a corrosion preventive fluid, designed for long-term protection against corrosion and, due to its residual hard film affords some protection against mechanical wear. Dinitrol 77B contains environmentally acceptable low aromatic solvents, which once evaporated leaves a thick, brown waxy film. Dinitrol 77B is primarily designed for cavity protection but may also be used for storage, transport and underbody protection.

#### Dinitrol 3125 HS

DA1991 500ml aerosol

DA1997 1 litre canister

Dinitrol 3125 HS is designed for application mainly as a cavity protection and a thin underbody coating. Main objects to be treated are used vehicles with some corrosion present. For improved performance on more corroded surfaces, Dinitrol ML or Dinitrol ML HS can be used as a pre-treatment. The slightly thixotropic nature of the product ensures an evenly applied film to the required thickness and strength.

#### Dinitrol 3654 / ML 4

DA1992 1 litre canister

The product is designed for application in closed cavities, doors and other parts. Dinitrol 3654 is also designed for use on spare parts etc, which are to be stored for long periods.

#### Dinitrol 4941

DA1996 500ml aerosol

DA1995 1 litre canister

Dinitrol 4941 is a black underbody chassis coating that contains self-healing properties to recover any small damaged areas within the coating layer. Once Dinitrol 4941 is applied to the underbody chassis area it seals and protects the surface from rust-accelerating water and oxygen.

#### Dinitrol Dröhnex 445

DA1994 500ml aerosol

DA1993 1 litre canister

Stone chipping & corrosion protection coating Black coloured long-term protection product against corrosion and stone chipping with a synthetic resin/plastic basis.

#### Dinitrol 449

DA1980 1 litre canister

Vehicle bitumen based underbody and stonechip coating Dinitrol 449 is an environmentally friendly black coloured bitumen based underbody and stonechip coating with good corrosion protection and sound deadening properties. After curing Dinitrol 449 has a very durable tough and elastic film, which results in a very good stonechip resistance. The product is NOT overpaintable

#### Dinitrol 977

DA1981 1 litre canister

Dinitrol 977 is a semi-transparent, waterbased liquid anti corrosion coating for the protection of cavity areas where a rust preventative surface is needed. The product is water-repellent and has very good penetrating properties. After drying remains a wax coating which has a good temperature resistance up to ca.+120 deg C and is almost tack free. When dried Dinitrol 977 is heated by sun or by engine-heat, it does not have the typical smell of conventional cavity-waxes.

*Dinitrol 449 and Dinitrol 977 can be used together to form a comprehensive water borne corrosion protection system application. Rather than applying both products separately, we recommend a two-layer application method with Dinitrol 977 and Dinitrol 449. This unique combination is very effective on surfaces that are already corroded.*

#### Dinitrol Converst RC 900

DA1998 400ml aerosol

Dinitrol RC 900 actively converts rust on substrates into a stable organic iron complex. Once the product is dry, an impermeable barrier against further corrosion is formed. Dinitrol RC 900 penetrates rust 7 to 10 times deeper than standard rust converters. The product forms a strong dry adhesive film that provides a suitable base for paintwork and other corrosion protection products.

#### Dinitrol ML

DA1958 500ml aerosol

DA1959 1 litre canister

This oil based brown coloured product is specially designed for applying into closed cavities such as doors, frame members and exterior joints and crevices. Dinitrol ML is a penetrating cavity wax ideal for rust-proofing second-hand vehicles. Can be used as a pre-treatment for Dinitrol 3125HS on more corroded surfaces after prior application of Dinitrol RC900 Converst.

#### Extended Nozzle

DA1983

600mm extended nozzle for aerosols. Ideal for applying the Dinitrol products.





Isopon Repair Consumables



Much more information available [www.britpart.com/isopon](http://www.britpart.com/isopon)

DA6609

Scratch & Stone Chip Filler

A durable easy to use filler that's been specially formulated to repair fine scratches, stone chips and other minor damage. Used straight from the tube, it dries fast and is easy to sand smooth ready to prime. Just follow the simple instructions in this guide for a quick and easy repair.

DA6607

Plastic Bumper Filler

A flexible easy to use filler that's been specially formulated to repair scratches and scuffs in most types of plastic. The pre-measured sachets make mixing simple and it can be easily sanded and shaped to the exact bumper contour. Highly flexible with excellent adhesion, the filler gives a smooth durable repair that's ready for priming and painting.



DA6606

Stone Chip Protector

Long lasting protection from stone chips and rust. Can be over-painted. Specially formulated to protect sills, side skirts and the underside of vehicles from stone chips and rust. The black, quick drying spray formula is fast, easy to use and gives long lasting protection with just two coats.

DA6276

Metalik Paste

Long recognised as one of the only body fillers that will adhere to a Land Rover's aluminium body. A two component multi-functional smooth metallic body filler paste used for the filling of holes & imperfections in most substrates. It has been specially formulated for the professional user

and combines good filling and smooth spreading properties together with ease of sanding. Metalik Paste is suitable for use on the following surfaces; bare metal, eg steel aluminium and zinc coated substrates (degrease and abrade with P80 paper), original painted surfaces (with the exception of thermoplastic acrylics - degrease and abrade with P180 paper) and GRP (degrease and abrade with P80 paper). 2K polyester body filler contains aluminium flakes and is smooth spreading with good adhesion & pinhole free. Sandable after 20 minutes (at 20C) and can be over-painted with most paint systems including 2K.

U-Pol Tiger Seal



DA6388BLK

Black

DA6388BW

White

DA6388GG

Grey

310ml cartridge

- > Non-shrinking
- > Permanently flexible
- > Can be over-painted

A one component ready to use polyurethane sealant and adhesive that bonds to most materials including steel, aluminium and most plastics. Ideal for sealing and bonding body panels, trims and seams.



Britpart

Hylomar Exhaust Paste & Putty



DA6672

Hylomar Exhaust Repair Putty

Specially formulated to fill small holes and cracks in exhaust systems thus delaying the need for replacement. 250g tub

- > Water based
- > Heat curing
- > Withstand high temperatures & pressure
- > Specifically designed for use in the assembly of exhaust systems for automotive and other general applications

Hylomar Exhaust Repair Putty is a water based, heat curing product. It has been specifically designed for use in the repair of exhaust systems for automotive and other general applications. The exhaust putty formulation will withstand both pressure and temperatures typically found in vehicle exhaust systems. When heated the product cures to form a gas tight seal.

Appearance - Viscous Dark Grey  
Specific Gravity @ 20°C (68°F) (ASTM D4659) 1.89  
Service Temperature - Up to 1,000°C



DA6673

Hylomar Exhaust Assembly Paste

Seals joints in exhaust systems and lubricates joints during fitting. 140g tube.

- > Water based
- > Heat curing
- > Specifically designed for use in the assembly of exhaust systems for automotive and other general applications
- > Asbestos free
- > Withstand high temperature and pressure

Hylomar Exhaust Assembly Paste lubricates joints to make assembly easier and faster. It is a water based, heat curing product and has been specifically designed for use with exhaust systems for automotive and other general applications. The exhaust paste formulation will withstand both pressure and temperatures typically found in vehicle exhaust systems.

Appearance - Light Brown/Beige  
Specific Gravity @ 20°C - (68°F) (ASTM D4659) 1.89  
Service Temperature - Up to 1,000°C



Photo by Mark Strangways



# CONSUMABLES

## Bodywork, Chassis & Workshop Consumables

### Loctite & Teroson Consumables

#### Body Repairs



#### Freeze & Release

**DA6310** 400ml aerosol  
Shock freezing (-43°C) is a quick and convenient method for releasing seized and corroded parts.

#### Chemical Metal

**DA6278** 180ml pack  
The original rock-hard multi-purpose repair paste.

#### Leak Fix

**DA6614** 180ml pack  
Seals and repairs leaks in petrol tanks, radiators and sumps.

#### Zinc Spray

**DA6326** 400ml aerosol  
Sprayable anti-corrosion primer paint for vehicle body repairs. Electrically conductive (wet and dry). Allow to cure for 8-12 hours before over painting.

**DA6326**



#### Gasket Repairs

#### Premium Silicone Black 5980

**STC50550** 100ml tube  
For flanges with permanent oil contact. Can be used for metal, plastic and painted parts. Low odour, non corrosive.

#### Premium Silicone Grey 5660

**DA6364** 100ml tube  
For flanges with permanent water/glycol contact. Can be used for metal, plastic and painted parts. Low odour, non corrosive.

#### Premium Silicone Copper 5990

**DA6365** 100ml tube  
For flanges exposed to high temperatures and high performance engines. Can be used for metal, plastic and painted parts. Low odour, non corrosive.

#### Silicone Blue 5926

**DA6366** 40ml tube  
Multi purpose flexible silicone sealant. For flanges of any size or shape. Can be used for metal, plastic and painted parts.

**STC50550**

**DA6364**



See website for full application details & technical specifications

# LOCTITE TEROSON®

#### Glues, Adhesives & Thread Lockers

#### Super Glue

**DA6300** 3g tube  
**DA6301** 5g bottle with brush  
High performance instant adhesive with thousands of applications.

#### Rear View Mirror Bonder

**DA6304** 1 shot tube  
Unique bonding system for rear view mirrors, car telephone aerials and all window mounted material.

#### Stud 'N Bearing Fit

**DA6306** 24ml bottle  
Locks and seals studs into position. Seals against leaks and vibration.

#### Super Steel Epoxy-Weld

**DA6314** 2 x 25g tube  
Sets like steel. Seals, repairs, bonds, fixes and replaces.

#### Instant Adhesive 3090

**DA6360** 10g  
Multiple-purpose 2-component, fast curing, gap filling adhesive.

#### Lock 'N Seal 243

**STC50552** 10ml bottle  
**DA6305** 24ml bottle  
**DA6307** 50ml bottle  
Replaces traditional locking methods. Prevents bolts, screws & nuts from vibrating loose.



Loctite product information visit - [www.britpart.com/loctite](http://www.britpart.com/loctite)



### Hylomar Sealants & Compounds



#### Hylomar 101 Silicone Sealant

**DA6441** Black  
**RTC3254** Ivory

Gasketing, sealing & bonding compound - 85% Hylomar Silicone Sealant is a non-corrosive, low odour, room temperature vulcanising (RTV) silicone compound. It is a high performance engineering grade which is used in the automotive industry and for general manufacturing. It can also be used for a variety of applications and is particularly suitable for high strength applications in odour sensitive environments. Hylomar Silicone Sealant has good resistance to oils and aqueous anti-freeze agents. Unlike general-purpose silicone sealants, Hylomar Silicone Sealant contains no solvents and does not evolve acetic acid during cure.

#### RTC3347

#### Hylomar Universal Blue

Gasket & jointing compound - 100g  
Non setting universal jointing compound that is resistant to fuels, coolants and lubricants. Use on gaskets and machined metal surfaces. High temperature capability up to 250°C with unlimited assembly time. Easy disassembly for service maintenance and allows for differential thermal expansion of components. Excellent vibration resistance.



#### DA3217 NEW

#### Hylomar 310

Silicone Sealant - 300ml  
Engineering grade acetoxy curing RTV silicone sealant. Forms any size or shape of gasket instantly. Remains flexible, will not shrink. Bonds to metal, glass, ceramics, plastics, fibres and wood. Resists most solvents. Electrical insulator



#### STC4404

#### Hylomar 607

Silicone Sealant - 300ml  
Engineering grade with excellent gap filling properties. Forms any size or shape of gasket instantly and remains flexible and will not shrink. Bonds to metal, glass, ceramics, plastics, fibres and wood. Resists most solvents. Good fluid resistance - not petrol or diesel. Electrical insulator with maximum constant operating temperature 250°C. Neutral curing. Tolerant of some oil and grease, ensure surfaces are clean.



#### STC4600

#### Hylomar 3400

Anaerobic Gasket Compound - 300ml  
Excellent resistance to automotive fluids including fuels with an operating temperature -40°C to 150°C. Machined metal to metal surface only, not suitable for pressed steel. No gap filling. Latest generation anaerobic gasket compound. Single part product. Suitable for K-series engines. Ensure surfaces are free of oil and grease.

**Bulk Workshop Fasteners & Fixings**



*Save time & effort with these packs of 100 of the more common Land Rover fasteners & fixings*

<b>1013938X</b>	Oil drain plug - Britpart	<b>BT606101X</b>	Bolt	<b>FS108257LX</b>	Bolt - M8 x 25 flange hex head
<b>1013938GX</b>	Oil drain plug - OEM	<b>BX110095MX</b>	Bolt - M10 x 45 patchloc	<b>FS108307LX</b>	Screw - M8 x 30 8.8 grade zinc clear
<b>215331X</b>	Bolt	<b>BYH500100X</b>	Nut & retainer	<b>FTC3697X</b>	Circlip
<b>251323X</b>	Self locking nut 7/8 BSF P-Type zinc/clear	<b>CZA4705LX</b>	Locknut	<b>FTC5150X</b>	Bolt
<b>252165X</b>	5/8 UNF Type P Nylon Inset Nut NEP	<b>DYC101420X</b>	Clip	<b>IPN500050X</b>	'A' Pillar clips
<b>302532X</b>	Special nut - spiralok	<b>DZM100080X</b>	Fastener - fir tree	<b>IYH000030X</b>	Hex nut
<b>320045X</b>	Floor screw	<b>EJP7738LX</b>	Layshaft nut	<b>LR045409X</b>	Bolt - 3/8 UNF x 1 1/8 x 3/4
<b>549473X</b>	Circlip	<b>FB108111LX</b>	Bolt - M8 x 55	<b>LR045926X</b>	Bolt - 3/8 UNF x 1 1/2 hex head x 5/8 thread
<b>571752X</b>	Gasket	<b>FRC2464X</b>	Felt washer	<b>LR082331GX</b>	Bolt
<b>78248X</b>	Pop rivet - 35mm	<b>FRC5413X</b>	Joint washer	<b>MRC2178X</b>	Nut & retainer
<b>79051X</b>	Nut insert	<b>FRC6968X</b>	Thrust washer	<b>MWC3136X</b>	Snapsac
<b>79221X</b>	Screw - door hinge - cone pointed UNF thread	<b>FRC7064X</b>	Copper washer	<b>MWC9918PMAX</b>	Plastic rivet
<b>AB614061LX</b>	Drive screw 14 x 3/4 pan posi AB S/T zinc/clear	<b>FRC7437X</b>	Spacer	<b>MXC1800X</b>	Fastener - fir tree
<b>AFU1075X</b>	Plastic rivet	<b>FRC9845X</b>	Differential thrust washer	<b>NH605041LX</b>	Nut - 5/8 UNF
<b>AFU1900X</b>	Fastener - fir tree	<b>FRC9847X</b>	Thrust washer	<b>NY606041LX</b>	Nut - 3/8 UNF nyloc
<b>AK616011X</b>	Nut wing	<b>FRC9849X</b>	Thrust washer	<b>NZ606041LX</b>	Propshaft nut - 3/8 UNF T-type nyloc
<b>AM605061X</b>	Acme bolt - 5/8 x 3/4 hex head	<b>FRC9851X</b>	Thrust washer	<b>RTC4820X</b>	Circlip
		<b>FRC9853X</b>	Thrust washer	<b>SYP500090X</b>	Bolt
		<b>FS108207LX</b>	Screw flanged head - M8 x 20	<b>UYH500020X</b>	Locknut



Photo by Paul Coene



# CONSUMABLES

## Fasteners & Fixings

### Trim Clips Kit



Available in refill packs of 100 - add X to the end of the part number

Handy  
**280** piece kit

#### DA6641

Box of assorted popular trim clips and fixings commonly used on Land Rovers. Supplied in a handy presentation box. 280 pieces.

Part Number	Description	Kit Qty	Replacement Pack Qty
AFU1075	Rivet	35	10*
ANR2224	Trim fastener	15	10
DYQ100230	Scrivet	15	10
AWR3994	Scrivet	15	5
DYC101420	Finisher clip	25	10*
MWC9134	Stud door casing	20	20
MWC9134BLUE	Stud door casing - blue	20	20
MXC1800	Fastener	20	10*
MWC3136	Snapsac	60	10*
DKP5279L	Door casing stud	25	10
DA1634	Fir tree roof insulation retainer	15	10



Refills available - please use the appropriate part numbers from the list.

### Clips, Clamps & Nipples



#### Jubilee Clips

CN100208L	20mm	Qty 10
CN100508L	32 - 52mm	Qty 5
CN100909	70 - 90mm	Qty 1

#### Exhaust Clamps

DA4062	45mm	Qty 1
DA4186	54mm	Qty 1
DA4063	60mm	Qty 1
DA4064	65mm	Qty 1

#### Grease Nipples

234532	Short thread	Qty 10
TYL100030	Long thread	Qty 10



Photo by Ali Zafar



# TOOLS

The Right Tools  
For The Job







**DA1115**  
**Timing Kit**  
Freelander 2 - 2.2 diesel  
Range Rover Evoque - 2.2 diesel  
Land Rover tool part numbers -  
303-1277 - Camshaft pulley timing pin  
303-1270/303-1059 - Flywheel locking  
timing pin  
303-1272 - Flywheel/ring gear locking tool  
adaptor



**DA1116**  
**Timing Kit**  
Discovery 3 - 4.4 V8 - from 2005  
Range Rover Sport - 4.2 V8 Supercharged -  
up to 2010 & 4.4 V8 up to 2010  
Range Rover L322 - 4.2 V8 Supercharged -  
2005 - 2010 & 4.4 V8 - 2005 - 2010  
Jaguar 4.2 & 4.4 V8 engines with codes 4PN  
& 428PS



**DA1120**  
**Flywheel Locking Tools & Camshaft Timing Pins**  
Discovery 3 - 2.7 TdV6  
Discovery 4 - 3.0 TdV6  
Range Rover Sport - 2.7 & 3.0 TdV6



**DA1121**  
**Timing Kit**  
Land Rover KV6 engines  
The Land Rover KV6 quad cam engine has one front and two rear camshafts and these tools cover the replacement of all three belts



**DA3140**  
**Timing Kit**  
2.5D/200 & 300Tdi - 12 piece



**DA1162**  
**Flywheel Locking Tool**  
Defender - 2007 onwards  
Land Rover tool part number - 303-698



**DA6120**  
**Fuel Pump Locking Tool**  
For use with DA1120 on 3.0 TdV6 engines



**LRT-12-158**  
**Timing Pins**  
**LRT-12-058**  
Timing pin (short) - Td5 engines  
**LRT-12-158**  
Timing pin (long) - Td5 engines



**DA6124**  
**Timing Kit**  
Range Rover Sport - 3.6 TdV8  
Range Rover L322 - 3.6 TdV8  
Designed to lock the camshaft and crankshaft in their timed position when performing engine rebuild or changing the cam chain. Packed in a foam tray and metal tin. Made in Sheffield.  
Equivalent to  
OEM 303-1236 - camshaft alignment blocks 2 x 2 + bolts  
303-1243 - flywheel locking plate  
303-1239 - camshaft rotating pin  
303-1238 - crankshaft timing pin



**DA6116**  
**Timing Kit**  
Freelander 1 - TD4 - M47 - 2000 - 2006  
Range Rover L322 - Td6 - 2000 - 2006  
This set enables the correct timing to be made when servicing the BMW M47 2.0 16 engines.



**DA6129**  
**Timing Kit**  
Range Rover P38 - BMW diesel  
Specifically designed for the 2.5 TDS diesel engines. This timing tool includes crankshaft holding tool, timing chain compressor, injection pump puller, shaft puller, crankshaft alignment pin, camshaft alignment tool & tensioner locking pins.



**DA6112**  
**Timing Kit**  
Defender - 2.4 TDCi  
Timing tool kit including timing pump removal and installation tools, camshaft/crankshaft sprocket alignment pin, chain tensioner, fuel pump cover removal tool and fuel injection pump sprocket locking tool. Supplied in metal case with foam tray.



**DA1667**  
**Fuel Pump Locking/Removal Tool**  
2.0 diesel Ingenium AJ200 diesel engine  
Discovery Sport  
Range Rover Evoque (2015 onwards)  
Jaguar F-Pace, XE, XF (2015 onwards).  
Engine codes: AJ-200D, 204DT, AJ200D, AJ200, 204DTD.  
Locks the fuel pump sprocket and chain in a fixed position while the pump is removed and replace. To be used with timing tool kit DA1668. Equivalent to 303-1672.



**DA1668**  
**Timing Kit**  
2.0 diesel Ingenium AJ200 diesel engine  
Discovery Sport/Range Rover Evoque (2015 onwards)/Jaguar F-Pace, XE, XF (2015 onwards) Engine codes: AJ-200D, 204DT, AJ200D, AJ200, 204DTD.  
For locking the engine into the timed position so the engine timing chain can be removed/replaced and the engine timing checked. To be used with fuel pump locking tool DA1667.  
Equivalent to  
303-1625 Camshaft holding tool  
303-1631 Camshaft adjuster locking/holding tool  
303-1630 Crankshaft pulley locking tool



**DA1847**  
**Timing Kit**  
Developed to allow the safe removal and replacement of the camshaft drive chains and check the engine timing on the Range Rover and Range Rover Sport 4.4L diesel engines.  
> Engine codes include:  
448DT (Diesel V8 4.4L)  
> Equivalent to OEM Tools: JLR 303-1620, 303-1568, 303-1243, 303-1571  
> Unique camshaft timing tool design - EU registered design



**DA7539 NEW**  
**Timing Kit**  
AJ200 Ingenium Petrol  
Discovery 5 - from 2017  
Discovery Sport - from 2017  
Range Rover Evoque - from 2017  
Range Rover Sport - from 2017  
Range Rover Velar - from 2017  
Kit contains all the essential components required to lock the JLR 2.0l Ingenium petrol engines in their timed position so that the engine timing chain can be safely removed and replaced and/or the engine timing checked. Made in Sheffield. Equivalent to OEM JLR-303-1630, JLR-303-1635 & JLR-303-1636. Petrol engine codes: AJ-20/PT204, AJ-200/PT204, AJ-200P/PT204, AJ200P, PT204 and AJ200.

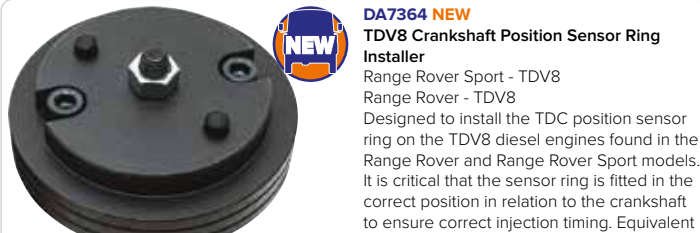

**DA7364 NEW**  
**TDV8 Crankshaft Position Sensor Ring Installer**  
Range Rover Sport - TDV8  
Range Rover - TDV8  
Designed to install the TDC position sensor ring on the TDV8 diesel engines found in the Range Rover and Range Rover Sport models. It is critical that the sensor ring is fitted in the correct position in relation to the crankshaft to ensure correct injection timing. Equivalent to OEM JLR-303-1237.



**DA3525 NEW**  
**Engine Locking Kit for V8 5.0L**  
Discovery 4/Range Rover Sport/Range Rover  
Engine codes include: AJ-133/508PS and AJ-133/508PN.  
Timing tools to lock the camshafts and crankshaft in their timed positions. Designed specifically for use on the post 2010 V8 5.0L petrol engines used across the JLR range. This 7 piece kit includes the camshaft, crankshaft, flywheel locking tools and the special camshaft turning tools with the tensioning wrench required to work on the engines listed.  
Equivalent to OEM: 303-1482, 303-1445-1, 303-1447, 303-1445-5, 303-1303 & 303-1452. Made in Sheffield.



**606435**  
Hub Nut Spanner

**DA1118**  
**Deep Socket**  
52mm deep socket - 1/2" drive  
Socket for adjusting hub nuts  
Defender/Series



**DA1111**  
Viscous Fan  
Coupling Spanner  
Two sizes - 32 & 36mm



**LRT-12-094**  
Viscous Fan  
Coupling Spanner  
V8 petrol/Td5 diesel/V6 2.7 diesel  
2.5 Td diesel/Td6 diesel/300Tdi



**LRT-12-093**  
Viscous Fan  
Coupling Spanner  
V8 petrol/Td5 diesel  
2.5 Td diesel/300Tdi



**DA1209**  
Fuel Tank Sender Wrench  
For easy removal of the fuel tank metal locking ring (ESR3808) on the Defender - 2002 onwards  
Discovery 1/Discovery 2/Freelander 1  
Range Rover P38/Range Rover L322



**DA6131**  
**DA6130**  
**DA6643**  
Alloy Wheel  
Nut Sockets  
27mm x 1/2" D  
22mm x 1/2" D  
21mm x 1/2" D  
> Nylon outer sleeve to protect alloy wheels  
> Manufactured from chrome molybdenum

**DA1662**  
**Whitworth Combination Spanner Set**

An 8 piece Whitworth combination spanner set. Manufactured from Chrome Vanadium with polished finish and supplied in a handy storage wallet. Sizes: 1/8", 3/16", 1/4", 5/16", 3/8", 7/16", 1/2", 9/16". Old Land Rovers need constant attention and sometimes a new set of Whitworth Spanners are just what you need! British Standard Whitworth threads are used in many classic cars and employ a different measuring system to the AF or Metric counterparts. It is essential to use corresponding Whitworth spanners for Whitworth fixings and the new 8 piece. This classic spanner set is essential for keeping that Landy running!



Whitworth socket sets. Manufactured from Chrome Vanadium. Complete with socket rail.  
**DA1665**  
**DA1663**  
**Socket Set - Whitworth 1/2" Drive**  
9 Whitworth sockets in bi-hex format with 1/2" drive. Sizes - 1/8" / 3/16" / 1/4" / 5/16" / 3/8" / 7/16" / 1/2" / 9/16" / 5/8"  
**DA1665**  
**Socket Set - Whitworth 3/8" Drive**  
7 Whitworth sockets with 3/8" drive. Sizes - 1/8" / 3/16" / 1/4" / 5/16" / 3/8" / 7/16" / 1/2"

**Oil Filter Tools**



**DA6118**  
Oil Filter  
Socket  
Freelander 2  
Range Rover Evoque 2.2 diesel  
27mm hexagon face drive with 3/8" D face drive. Removes paper filters without damage to the plastic filter housing. Manufactured from Chrome Vanadium.



**DA1176**  
Oil Filter  
Socket  
36mm oil filter socket - 3/8" drive  
Designed to protect the corners of the filter from damage. Defender - Puma 2.2 & 2.4. Freelander 1 - Td4. Range Rover L322 - 2002 - 2009 - M57 3.0 diesel & M62 4.4 V8 petrol



**DA1117**  
Td5 Oil Filter Spanner  
Defender  
Discovery 2  
**Note** - Will not fit Mahle or Delhi filters. Britpart filters only - LPX500190



**DA6638**  
Oil Filter  
Wrench  
Cup style  
65mm x 14 flutes  
Suitable for AJ200 Ingenium engines

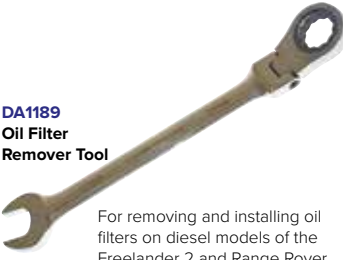

**DA1189**  
Oil Filter  
Remove Tool  
For removing and installing oil filters on diesel models of the Freelander 2 and Range Rover Evoque. 27mm combination spanner with flexi-head. 400mm long. Manufactured from Chrome Vanadium. Fully polished with ratchet. Manufactured to Ansi standards.



**DA1173**  
Oil Filter Remove Tool  
To remove the paper element from the canister. Prevents damage to the filter housing.  
Discovery 3 - TdV6  
Discovery 4 - TdV6  
Range Rover Sport - TdV6  
Land Rover tool part number - 303-1128



**DA7488**  
Laser Two Way Ratcheting Oil Filter Wrench  
> Ratcheting function to install and remove the oil filter quickly and easily  
> Non-slip steel jaws securely grip the oil filter  
> 1/2" drive  
> Size range: 60 - 80mm



Photo by Ming Lee



# TOOLS

## Brake Tools



**204-591-01**  
Dynamic Response System Bleed Bottle  
**Note** - For professional use only.



**DA7361 NEW**  
**Brake Cylinder Hone**  
For use with a cordless drill to clean brake cylinders during service.  

- > Self aligning
- > Spring tension adjustment - 22mm - 69mm
- > 29mm stones
- > Flexible shaft
- > For use with a standard drill



**Brake Caliper Rebuild Tool Kit DA1153**  
After a brake caliper rebuild the most difficult part can be fitting the dust seal after the pistons have been fitted. Make that task easier with the seal fitting tools in this kit. The kit is supplied with a tool to fit 41mm and 44mm pistons and comes complete with a heavy-duty piston spreader to allow the seals to be pushed into place evenly.  
**DA7460**  
Heavy-duty piston spreader only.

**DA7484**  
**Laser Automatic, Self Adjusting Brake Pipe Cutter With Ratchet Handle**  

- > Ratcheting, self adjusting mini brake pipe cutter ideal for restricted access
- > 4.75mm (3/16") with ratchet handle
- > Automatic self adjusting for faster cutting. Fast and accurate operation, ideal for under vehicle use
- > Extra leverage due to handle length over standard cutter. To further increase leverage use the 1/4" drive square in the end of the handle

Brake pipe cutters can be quite small and compact but there are instances when working where there is still not enough clearance to turn the cutter around the whole of the brake pipe. This mini brake pipe cutter solves this problem with its ratchet mechanism. Simply slide the cutter over the pipe - the handle gives excellent leverage and even if the space is really restricted, a few turns of the handle will quickly and cleanly cut straight through. It is self-adjusting, so no need to keep tightening the blade down onto the pipe as you are cutting. Quick and easy. Use on 3/16" or 4.75mm brake pipe, steel, cupro nickel or copper.



**DA6136**  
**EPB Brake Adaptor**  
Adjustable 3 pin EPB brake adaptor with standard 2 pin drive which is adjustable to fit many modern vehicles. Kit also contains a pneumatic brake caliper rewind tool - 3/8" D. This tool is for left and right hand threaded pistons. Suitable for most 3/8" D wind-back adaptors and pin type adaptors. A great time saver in the workshop.



## Crankshaft Tools



**DA1160**  
**Engine Front Casing Alignment Tool**  
Defender - 2007 onwards  
Land Rover tool part number - 303-682



**DA6550**  
**Crankshaft Trigger Wheel Installer Tool**  
Discovery 3/Discovery 4  
Range Rover Sport - Mk1  
Required to install the crankshaft position sensor ring when fitted with TdV6 engine. Specifically required to repair sensor wheel dropping off or cracking.  
Equivalent to OEM 303-1130  
Overall dimension: 123.5mm



**DA6114**  
**Crankshaft Rear Seal Remover/Installer Tool**  
Range Rover Sport  
2005 - 2009 - 4.4 & 4.2 V8 petrol  
Range Rover L322  
2002 - 2013 - 4.4 & 4.2 V8 petrol  
Discovery 3 - 2004 - 2009 - 4.4 V8 petrol  
Suitable for use on vehicles with the petrol AJV8 engine both N/A and supercharged. Comes complete with punch to assist seal removal on Freelander 2- 2.2Td4.  
Equivalent to OEM 303-538.



**DA6133**  
**Crankshaft Pulley Holding Tool**  
Provides the required components to hold the crankshaft vibration damper in place whilst undoing the very tight pulley mounting bolt. Equivalent to OEM 303-191, 303-192, 303-193, 303-194. Designed to be used with a 1/2" D Power Bar. For use on AJ V8 3.2, 4.0, 4.2 & 4.4 petrol engines.



**DA1161**  
**Crankshaft Front Seal Remover/Installer Tool**  
Defender - 2007 onwards  
Older type seals - LR029318 & LR045106  
Land Rover tool part number - 303-679



**DA1845**  
**Crankshaft Seal Installation Tool**  
Freelander 2 - 2.2 diesel  
Range Rover Evoque - 2.2 diesel  
Jaguar XF - 2.2 diesel  
Designed to allow the rear (flywheel end) crankshaft oil seal fitted to Land Rover 2.2 diesel engines to be installed without damage. The tool allows the rear oil seal to be pulled in to place in a controlled manner significantly reducing the chances of damaging the seal's sealing lip.  

- > Equivalent to OEM 303-1271
- > Keep threaded components clean and well lubricated with clean engine oil when in use.



**DA3246**  
**Crankshaft Front Oil Seal Installation Tool**  
Freelander 2  
Range Rover Evoque - 2011 - 2015  
Designed to be used to fit the front crankshaft seal on the 2.2 DW12 diesel engines without damage to the seal or the crankshaft. Made in Sheffield.  
Equivalent to OEM JLR-303-1274.



**DA7360 NEW**  
**Front Crankshaft Oil Seal Fitting Tool for AJ200 2.0L Diesel**  
Engine applications 2.0L AJ200 diesel engines (engine code AJ200/204DT)  
Defender - from 2020  
Discovery Sport - 2015 - 2019  
Range Rover Evoque - 2015 - 2019  
Range Rover Sport - 2016 - 2018  
Range Rover Velar - from 2017  
E-Pace - from 2017 / F-Pace - 2016 - 2020  
XE - 2015 - 2020 / XF - 2015 - 2020  
Designed to engage with the front bayonet style crankshaft oil seal and allow the user to remove and fit the seal. Specifically used on 2.0L AJ200 diesel engines found across the Jaguar and Land Rover ranges. Fitted with 1/2" D drive. Equivalent to OEM JLR-303-1628. Made in Sheffield.



**DA1899**  
**Crankshaft Locking Kit**  
Defender - Puma 2.2  
Used to lock and time the crankshaft and flywheel to allow the TDC sensor position to be set after removal when servicing the cam chain drive system.



**JLR-303-1619**  
**Crankshaft Front Seal Remover & Installer Tool**  
Defender - 2007 onwards  
Newer type seals - LR077704

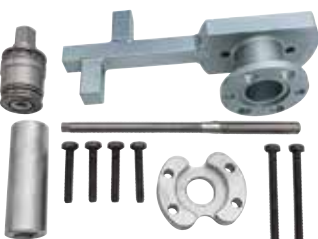

**DA3536 NEW**  
**Crankshaft Pulley Set for V6 3.0L & V8 5.0L**  
Discovery 4/Range Rover Sport/Range Rover  
Engine codes include: 3.0L AJ-126/306PS, 5.0L AJ133/508PS and 508PN.  
Set of tools required for the removal of the front crankshaft pulley (crankshaft vibration damper) fitted to the JLR 3.0L V6 and 5.0L V8 petrol engines. The crankshaft pulleys used on these engines are tightened to 200Nm + 270 degrees so are very tight to undo and must be held by a substantial holding tool which the kit provides. Also included in the kit are the pulley puller components required to remove the pulley without damage. Important: Ensure the force screw is well lubricated with molybdenum disulphide grease before use.



Join our regular newsletter  
[www.britpart.com/newsletter](http://www.britpart.com/newsletter)





**Propshaft Fastener Tools**

- DA1065 3/8" square drive
- DA1119 1/2" square drive
- > Size - 3/8" 6 point (hexagon)
- > Total length - 150mm
- > Outside diameter - 20mm

Specialist socket for propshaft fasteners on most Land Rovers. The 3/8" socket end is a perfect hexagon with rounded tip profiles to ensure the whole turning power is transferred onto the flanks of the nuts instead of on the corners. The socket's slim wall construction and wine glass profile, coupled to an integral slimline extension means it fits perfectly between the UJ yokes and over the propshaft nuts without fouling. The 3/8" AF nuts are common to Series, Defenders (90 & 110 up to latest vehicles), Discovery 1, Discovery 2, Range Rover Classic and Range Rover P38.



**DA6111 Oil Pump Alignment Tool**

Defender - 2.2 TD4 diesel - 2006 - 2015  
Developed to correctly align the engine oil pump in the sump after an engine rebuild as it is important that the pump be correctly and accurately aligned to ensure the oil pump sprocket is not operating with excessive side loads.



**DA6132 Cooling System Pressure Test Kit**

A comprehensive cooling system pressure testing kit for universal use. 24 pieces including 16 individually sized adaptors, pressure testing pump with gauge, 2 pressure cap test connectors for use with No 3 adaptor and handle. Checks the leakage on original radiator cap. Application list and instructions included. The pressure pump is hand operated and is fitted with an accurate and easy to read gauge marked in both psi and bar. This kit includes a thermometer to aid diagnostics and also ensure the system is cool before removing the cap. Also included in this kit is a very useful radiator pressure cap tester.



**DA1155 Panel Popper Tool Kit**

12 piece set designed to aid in the easy removal of door trim panels, trim fasteners and mouldings inside or outside the vehicle. Manufactured from a tough & durable engineering plastic to minimise panel damage. Includes an additional metal clip tool.



**DA7362 NEW Airbag Removal Tool**

Discovery 3  
Discovery 4  
Freelander 2  
Range Rover Sport  
Designed to release the driver airbag module from the steering wheel.  
Equivalent to OEM 501-106



**DA1235 Locking Tool**

Defender - Puma  
Locking tool to restrain the fuel injector sprocket during a fuel pump removal or installation.



**DA1839 Glow Plug Compression Adaptor Kit**

2.0/2.2(TD4)/TDV6/TDV8 & 2.2 Ingenium  
A selection of diesel glow plug compression test adaptors specifically designed to allow Laser diesel compression testers (4510 & 2596) and cylinder leakage tester (5140) to be used on the current range of Jaguar & Land Rover diesel engines including the 2.2 TD4, TDV6, TDV8 and the latest Ingenium engines. The kit includes a specially designed 90 degree connector to allow access on TDV6 engines where the oil filter obstructs normal access.

- > 3 glow plug adaptors for compression and cylinder leakage testing
- > Equivalent to OEM 60228, 60229, 60232
- > Designed to be used with Laser Compression & Cylinder Leakage testers. Part Nos. 4510, 2596, 5140



**DA6134 Diesel Fuel System Bleeder Kit**

Freelander 2 - 2.2 diesel  
Range Rover Evoque - 2.2 diesel  
Hand pressure pump and 4 adaptors. For bleeding/priming the system after fitting new filter or other maintenance on the fuel system. Essential service tool.



Britpart



**DA1841 Easy Flow Pump for 20-25L Drums**

Suitable for engine oil, gear oil, diesel and antifreeze.

- > Not suitable for corrosive or water based fluids
- > Supplied with a 48" non-kink discharge hose and non-drip steel nozzle plus extending suction tube
- > Pump head features D-handle for easy down stroke, drum refill plug (no need to remove pump to refill drum) and drain back port
- > Delivery flow is 0.9L per 14 strokes



**DA1749 Steering Drop Arm Puller**

Defender - 1987 - 2006  
Designed for the removal of the steering drop arm from the steering box. The Defender steering drop arm can wear because of its position low down at the front of the chassis - it's exposed to all the road spray and water that gets thrown at it. Water gets into the joint and eventually you will have to replace the drop arm and ball joint because the rust has corroded it. However splitting the steering drop arm from the steering box can be problematic because the steering drop arm and the steering box splines corrode together. This tool solves that problem. Supplied with a spare threaded bar.



**DA1844 Differential Pinion Shaft Holding Tool**

Freelander 2  
A 2 piece kit providing the special pinion nut holding tool and splined deep socket to allow the removal and installation of the rear differential pinion shaft nut when rebuilding the rear differential in accordance with Land Rover OEM instructions.

- > A two piece kit including Bi-Hex pinion nut holding tool and splined socket
- > Use with suitable torque wrench with a 250Nm minimum capacity (see Laser 7169)
- > Equivalent to OEM tool JLR-205-984



**DA7477 Gearbox/Axle Filler Pump**

1 litre capacity. This handy mini pump makes all top up jobs easy. Ideal for gear boxes and differentials and is suitable for oils, automatic transmission fluids, brake fluids and general purpose cleaners.

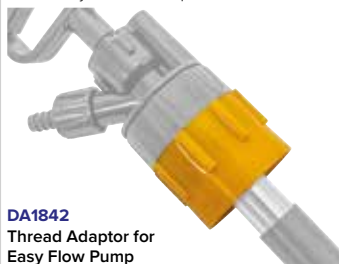

**DA1842 Thread Adaptor for Easy Flow Pump**

Two adaptors for use with DA1841 Easy Flow Pump. Suitable for use with engine oil, gear oil, diesel and anti-freeze. Specifically designed to convert the female thread (DIN 61mm) drum pump 57mm (M) + 2" BSP (M) adaptor.



**DA1840 Front Lower Ball Joint Tool**

Discovery 3/Discovery 4  
Range Rover Sport - 2005 to 2014  
Allows the bottom ball joint to be replaced and fitted without removing the lower wishbone assembly

- > Designed for use on the vehicle saving significant time and additional parts costs
- > Equivalent to OEM 204-531
- > Always lubricate the force screw with molybdenum disulphide grease



**DA1125 Ball Joint Remover Tool Kit**

Fit & remove RBG000010 to a Defender drop arm without having to remove the arm from the vehicle.



**DA5631 Wing Protectors**

Protect your Defender's wings with a pair of these sturdy, easy to fit wing protectors.



**DA6135 GEN2 Wheel Bearing Kit**

Freelander 2 - 2006 onwards  
82mm / Front  
This kit enables you to be able to remove and replace the bearing/flange in situ.



### DA1698

**All-In-One Stud & Hub Cleaning Tool**  
Stud Klean attaches firmly to a standard impact wrench, providing the fastest and safest cleaning solution for your wheel changing process. The face of the tool moves rust and contaminants in seconds, providing a smooth clean surface for ease of assembly of all mating parts. At the same time, stainless steel tines effectively clean the threaded studs assuring easy and accurate torquing of lug nuts. The proprietary abrasive material is significantly longer lasting than any other material on the market.



#### Features

- > Cleans the hub and stud at the same time
- > Fits to 1/2" impact
- > Single size for all passenger cars and light trucks
- > Won't damage your wheels
- > Dense, long lasting abrasive pad
- > Hundreds of internal stainless steel tines instantly & effectively clean threaded studs
- > Stack tolerances when balancing wheels will improve and ensure proper torque tensioning during installation
- > Cleans approximately 800 wheels

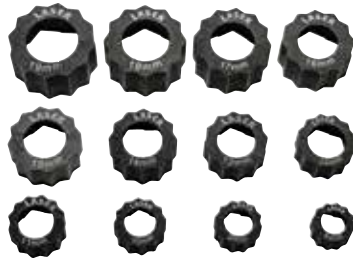

### DA1878

#### Laser Damaged Nut/Bolt Extractor Set - 12 Piece

This kit is made up of a set of cleverly designed hexagon bolt and nut extractor adaptor caps. The caps fit over the rounded off fixing and allow a standard 12 point socket or ring wrench to be used to remove the rounded off hexagon fitting.

- > Sizes: 8, 9, 10, 11, 12, 13, 14, 15, 16, 17, 18 & 19mm
- > Specially hardened steel components finished in black
- > Can be used on up to 65% rounded nuts
- > Due to material used, the tools should be considered consumable. Following the instructions for use will help significantly increase the service life of the kit

Watch in action @ [britpart.com/DA1878](http://britpart.com/DA1878)



### DA7489

#### Laser Impact Twist Sockets

Ideal for removing damaged nuts and bolts. Impact twist socket 1/2" drive, manufactured from SCM440 steel.

- > Sizes: 17, 18, 19, 21, 22 & 24mm
- > 1/2" drive
- > Supplied in EVA foam for tool box storage
- > Manufactured from SCM440 steel with black finish
- > Special profile for removing damaged nuts and bolts

### DA7490

#### Laser Breaker Bar With Built-in Impact System

330mm long breaker bar with built in impact system allowing the bar to be loaded with one hand and then impacted with a hammer for significantly increased force. Ideal where air tools are not an option.

- > Bi-directional for removing left or right handed stubborn nuts and bolts using combine hand and impact force
- > Swivel head gives access to difficult areas
- > Use with impact socket and bits
- > 330mm long x 1/2" drive
- > Impact absorbing composite grip handle

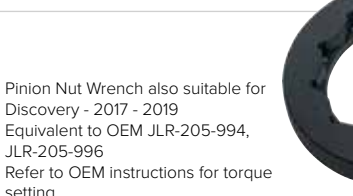

### DA1875

#### Laser Torx Fixing Extractor Set - 11 Piece

An essential workshop tool for extracting Torx fixings.

- > Manufactured from S2 silicon steel
- > 7 x Extractors with 6mm Hex drive (quick chuck)
- Sizes - E10, E15, E20, E25, E27, E30, E40
- > 3 x Extractors with 10mm Hex drive
- Sizes - E45, E50, E55
- > 1/2"D x 10mm Hex adaptor
- > Storage case

Watch in action @ [britpart.com/DA1875](http://britpart.com/DA1875)



### DA1876

#### Laser Damaged Cap Head Bolt/Screw Extractor Set - 11 Piece

For removing damaged hex bolts and screws.

- > 7 x 1/4" Hex shank
- Sizes - 1.5, 2, 2.5, 3, 4, 5 & 6mm x 50mm long
- > 3 x 10mm Hex shank x 7, 8 & 10mm x 38mm long
- > 1/2"D x 10mm Hex adaptor
- > Storage case

### DA1877

#### Laser External Deburr/Chamfer Tool

External deburr/chamfer tool fitted with HSS blade for repairing damaged bolts. Effective on stainless steel, hardened steel, mild steel, copper, brass, wood, fibreglass, hard plastic.

- > Size range 3 - 19mm
- > Speed 0 - 400rpm
- > High speed steel blade 1/4" shank

In a busy workshop there are numerous instances of threads getting damaged: whacking a track rod end with a hammer; cutting a bolt or threaded rod - the threaded ends get torn and squashed. Wheel studs get damaged just by removing and refitting the wheels... Luckily there is a quick and easy solution - the external deburr & chamfer tool. Watch in action @ [britpart.com/DA1877](http://britpart.com/DA1877)



### DA7487

#### Laser Short Circuit Diagnostic Kit

Tracing a short circuit can be a very time consuming exercise. This Short Circuit Diagnostic Kit provides the solution in the form of a set of circuit breaker fuses that are designed to fit in place of the traditional fuse. The circuit breaker will safely break the circuit when an overload is detected just like a conventional fuse but unlike a conventional fuse it is manually resettable allowing the technician to reset the circuit breaker fuse to run their tests as many times as they need. The kit provides resettable fuses for both standard and mini size blade fuses. Where space is really tight the set includes two 300mm extension leads which allow the circuit breaker fuse to be connected where space in the fuse box is tight.

- > Contents includes: 7 standard blade manually resettable circuit breaker fuses & 7 mini blade manually resettable circuit breaker fuses.
- > Fuse ranges: 5A, 7.5A, 10A, 15A, 20A, 25A, 30A.
- > 300mm (12") extension loop leads for better access for use with both blade sizes.

### DA2799

#### Laser Differential Pinion Holder & Wrench Set

- > 2 piece set including 1/2" D spline pinion socket with 1/2"D pinion nut wrench
- > Applications include Range Rover - 2013 - 2016 Range Rover Sport - 2014 - 2016

- > Pinion Nut Wrench also suitable for Discovery - 2017 - 2019
- > Equivalent to OEM JLR-205-994, JLR-205-996
- > Refer to OEM instructions for torque setting



### DA7485

#### Laser Cordless 30W Soldering Iron

- > Cordless 30w soldering iron with rechargeable Li-ion battery (2400mAh)
- > Supplied cone tip, chisel tip, heat shrink tip, 15g solder, cleaning sponge, stand, cap & USB charging cable
- > Charging time 3 - 5 hours; one charge provides 35 minutes of use
- > LED illumination
- > Reaches working temperature 180°C in 10 seconds. Maximum temperature up to 600°C
- > Internal charging board protects against overcharging, short circuit and electro static discharge



### DA7486

#### Laser USB Soldering Iron

- > Soldering iron designed to be powered by a USB socket (1 amp current draw)
- > Heats up to 185°C in approx 15 seconds
- > Maximum temp 480°C
- > Supplied with a 1.2m USB lead
- > Folding stand included

### DA2789

#### NORMA® Fuel Line Repair Kit

One stop solution to repair defective fuel lines in under five minutes

- > Economical solution to repair defective spots instead of replacing complete fuel lines
- > Access to OEM quality materials
- > Easy identification of the components within the kit with the help of product descriptions



- > Standard quick connector - spigot connection as per SAE J2044 Safety aspect: NORMAQUICK® S connector cannot be opened under pressure
- > Very high pull-off forces of quick connectors due to four locking arms ABA Mini provides excellent clamping force compared to screwless clamps

**DA1650**

**Automotive Current Tester  
LCD Display**

This automotive current tester with LCD display, plugs directly into the fuse box and can be used on mini, standard and maxi fuse connections. Blades may get hot during use and care should be taken for 2 mins whilst they cool down.

- > Fits mini and maxi fuses
- > Current range 0-80A
- > Safe and easy way to check automotive current
- > LCD display
- > Hold and peak function with bar graph



**DA7288**

**Automotive Current Tester**

For the rapid safe and accurate testing of DC current on 12v vehicles. The tool plugs straight into the vehicles fuse board and displays the current on the large LCD display. Specification range 0-48volt max 20 amps, 12v battery included.

- > Quick and safe
- > Plugs straight into the vehicle fuse board
- > Large LCD display
- > Specification range 0-48volt max 20 amps
- > 12v battery included



**DA3247**

**Balance Shaft Removal  
& Installation Kit**

Discovery 5

Discovery Sport - 2015 - 2019  
Range Rover Evoque - 2015 - 2019  
Range Rover Sport - 2016 - 2018

Range Rover Velar - 2017 -

Designed to allow the safe removal, fitting and timing of the gear driven balance shaft on the Jaguar Land Rover AJ200 2.0L diesel engines. The kit contains all the essential components to enable the balance shafts to be aligned when reassembling the components. Made in Sheffield. Use in accordance with OEM instructions. Equivalent to OEM - JLR-303-1662 / JLR-303-1663-1 / JLR-303-1663-2 / JLR-303-1663-3 JLR-303-1664 / JLR-303-1665



**DA3248**

**Long Series Hex Bit 3/8" D 11mm**

Ideal for injector clamp bolts and caliper bolts. Size: 11mm x 100mm long. Socket manufactured from Chrome Vanadium. Bit from S2 Steel.



**DA7399**

**Exhaust Gas Temperature Sensor Socket**

Range Rover L322 - 2011 - 2012  
Range Rover L405 - 2013 - 2017  
Range Rover Sport Mk2 - 2014 - 2017

- > Required to remove/install the exhaust gas temperature sensor
- > Equivalent to OEM 303-1573
- > 13mm hex x 6mm deep
- > Socket equipped with a 13mm hex to use with appropriate spanner or wrench
- > Made in Sheffield.



**DA3499 NEW**

**Automatic Gearbox Alignment Tool**

Defender/Discovery 1/Discovery 2/Range Rover Classic/Range Rover P38

An essential tool for the correct setting and alignment of the XYZ switch (gear selector position and starter inhibitor switch) on the ZF4HP22, ZF4HP24, ZF4HP44 automatic gearboxes. Equivalent to OEM 307-498 & LRT-44-011. Made in Sheffield.



**DA3524 NEW**

**Hub Puller Adaptor Kit**

Hub puller plate for use on 3, 4 and 5 bolt fixing drive flanges.

- > PCD 97 - 123mm
- > Complete with 5/8" UNF adaptor for slide hammer
- > 1 1/2" x 16tpi plate thread allows use of hydraulic ram
- > Can also be used with an impact force screw

Photo by Martin Price



# TOOLS

## Bush Tools



**DA7463**  
Rear Suspension,  
Lower Hub Bush Removal  
& Installer Tool

Equivalent to OEM 204-516.  
Discovery 3/Discovery 4  
Range Rover Sport - 2005 - 2013  
Range Rover L322 - 2002 - 2012

The lower hub bush tool (DA7463) and the upper hub bush tool (DA7466) have been developed to allow the technician to remove and refit these rear suspension bushes with the minimum of dismantling required. Being able to perform the task on the vehicle saves considerable time over the more traditional use of a workshop press and the requirement that the hub be completely removed. For reference, the DA7463 bush tool (OEM equivalent 204-516) has been specifically designed to work with OEM bush RBK500220, and the DA7466 bush tool (OEM equivalent 204-515) has been specifically designed to work with OEM bush RHF000260.

**DA7466**  
Rear Suspension,  
Upper Hub Bush Removal  
& Installer Tool

Equivalent to OEM 204-515.  
Range Rover L322 - 2002 - 2012



**DA7465**  
Front Suspension  
Lower Arm Front Bush  
Removal & Installer Tool

Equivalent to OEM 204-536.  
Designed to remove and refit the front suspension bush of the lower arm with the minimum of dismantling.  
Discovery 3/Discovery 4  
Range Rover Sport - 2005 - 2013

**DA7461**  
Front Suspension Lower Arm  
Rear Bush Removal & Installer Tool

Equivalent to OEM 204-535A. For use with RBX500291. Can be used on the vehicle saving time and money.  
Discovery 3/Discovery 4  
Range Rover Sport - 2005 - 2013

**DA2883**  
Rear Suspension Hub Bottom  
Bush Removal & Installer Tool

Freelander 2 & Range Rover Evoque  
This tool has been developed to allow the user to safely remove and replace the rear hub bottom bush. It's been specifically designed for use with minimal strip down of the vehicle components for the removal and replacement of the bush. Use on vehicle with the minimum of suspension dismantling required. Uses a mechanical force screw. Always ensure the force screw is clean and lubricated with molybdenum disulphide grease. For use with hand tools only.



**DA7464**  
Rear Suspension  
Upper Hub Bush Removal  
& Installer Tool

Equivalent to OEM 204-530. Designed for OEM bush RHF500100. Can be used in situ which saves time and reduces the dismantling required.  
Discovery 3/Discovery 4  
Range Rover Sport - 2005 - 2013



**LRT-60-004**  
Bush Fitting Tool

For front radius arm bushes (part number ANR3332) for the Range Rover P38A - impossible to do without using this Land Rover special tool.

## Calibration Tools

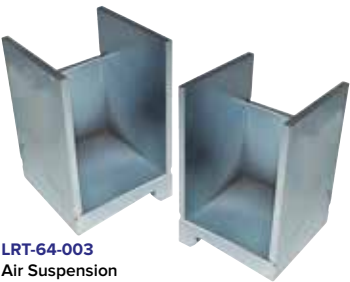

**LRT-64-003**  
Air Suspension  
Calibration Blocks

Discovery 2  
To be used in conjunction with Lynx diagnostics kit.



**LRT-60-003**  
Air Suspension  
Calibration Blocks

Range Rover P38  
To be used in conjunction with Lynx diagnostics kit.

## Clutch Tools



**DA1147**  
Clutch Alignment Tool

Defender - 2007 onwards  
Discovery 3 - TdV6 manual  
Replace two tools for one with this cost effective clutch tool. One end is the Land Rover 308-419 clutch alignment tool which is used to align the clutch disc and pressure plate on installation. The other end of the tool is Land Rover 303-1096 aligner/installer tool which is used to align the clutch drive plate and install the spigot bearing.



**DA6113**  
Clutch Alignment Tool

Defender - 2.4 TD4 - 2007 onwards  
Specifically designed to hold the clutch centre plate centred on the flywheel while fitting the clutch cover plate. Ensures fast effective alignment of the clutch centre plate. 200mm long x 14mm dia with knurled grip. Equivalent to OEM 308-419.



Photo by Jundio Salvador



Launch UK



DA6860

DA6866

Launch UK

Automatic Transmission Fluid Exchange Machine

Excludes Land Rover application kit - DA6863  
It is recommended that a fluid and filter change are carried out before 75,000 miles or 50,000 miles in arduous conditions. The only practical way to do this and ensure a 99% fluid exchange is using dedicated equipment. Overtime fluid and additives in your Land Rover deteriorate, this can have impacts on the transmission by causing the carefully engineered friction coefficients and viscosity to alter. This can lead to harsh engagements and rough or slipping shifts as the critical, controlled clutch slip no longer responds as designed. Ultimately premature and expensive transmission failure is likely. Changing the fluid at 75,000 miles helps to restore operation and protect the transmission in the future. The Launch UK CAT501S is an automatic transmission fluid exchange station which ensures a fast and trouble-free fluid exchange. Unlike traditional emptying methods of draining from the sump plug, the ATF machine will run a flushing detergent through the gearbox and exchange 99% of the total oil capacity. The CAT 501S is a fully featured product with a straightforward menu driven interface making it easy to use. Provided with a full set of adapters allowing connection to virtually all transmission types.

Benefits of Fluid ATF Oil Service

- > Smoother gear change
- > Reduced transmission noise
- > Easier gear selection
- > Reduced transmission vibrations
- > Faster up shift during acceleration

DA6863

Launch UK Land Rover ATF Fitting Kit

A complete fitting kit for attaching a gearbox fluid exchange machine, to all modern Land Rover and Range Rover models. It includes modern 8HP gearbox fittings, 9 speed Evoque as well as all 4, 5 and 6 speed applications including the 5L40E gearboxes on early Range Rovers. Cooler pipe fittings and direct to the gearbox are included, for varied application. Full instructions are included, advising where to attach the fitting for each model. Ideal for Land Rover garages as this kit is compatible with other brands of ATF machines.



DA6863

DA6861

Launch UK

Automatic Transmission Flushing Fluid

400ml x 24 bottles

This product is designed to effectively remove oxidised oil deposits, and other contaminants that can be present in +40,000 mile automatic transmissions. Suitable for all transmission types.

Advantages

It is particularly suitable for use with the Launch CAT501 fluid exchanger, or similar. It safely removes contaminants from Mechatronic units, valve bodies, torque converters and other moving parts. Allows fresh oil to work correctly in a decontaminated environment, ensuring smooth gear shifts.

Application

It is best used with fluid exchanging equipment, but can also be used without. Run vehicle at normal operating temperature for 10-15 minutes through all ratios and lever positions on a vehicle lift. Carry out oil exchange following the manufacturers guidance. 400 ml will treat up to 10 litres of ATF, for higher capacities add 40ml per litre.

DA6862

Launch UK Automatic Transmission Conditioner - Care & Protect

400ml x 24 bottles

When added to automatic transmission fluid this product will support the fluid in resisting oxidation and ensuring maximum temperature stability, resulting in consistently smooth gear shifting.

Advantages

The product will enhance the function of many fluids, helping to reduce oxidation and extend the effectiveness of the complex additive packs present in automatic transmission fluids

Application

The product is best applied using the Launch CAT 501S Fluid Exchanger or a compatible machine. It can be applied manually, and will treat new and old fluid, usually through the level plug, or top up point. 400ml will treat up to 10 litres of fluid. Larger capacities add 40ml per litre.



Wynn's TranServe™ Consumables

DA6867 NEW

Wynn's Automatic Transmission Flush

325ml x 12 bottles

An oil soluble treatment developed to clean automatic gearboxes and restore their optimal operation.

- > Safely removes varnish deposits
- > Prepares transmission for new fluid
- > Cleans all internal transmission components
- > Smooths and quietens gear changes
- > Prolongs component life
- > Restores optimal gear shifting
- > Only to be used with TranServe machine



DA6248

Automatic Transmission Treatment

325ml x 12 cans

An oil soluble supplement developed to stop and prevent leaks and ease shifting.

- > Stops and prevents leaks
- > Rejuvenates rubber seals & O-rings
- > Cleans and protects the system by means of detergents & dispersants
- > Eases shifting
- > Prevents ageing and oxidation of automatic transmission fluids
- > Prolongs component life
- > 1 can of 325 ml treats up to 6.5 litres automatic transmission fluid



DA6799

Replacement filter for DA6800



Photo by Sirsendu Gayen





**DA5085**  
**Ring Zoom300 LED Inspection Torch with Power Bank**

- > Up to 300 lumen torch - provides bright white light with 6000K colour temperature
  - > Standard setting has a wide-angle light output for total illumination of the work area
  - > 6x Optical zoom - for a focused beam of light to see into the distance
  - > Maximum power mode (300 lumens) - lasts for 4.5 hours
  - > Maximum life mode (150 lumens) - lasts for 10 hours
  - > Complete with USB to Micro USB cable - for convenient recharging (6 hours recharge time)
  - > Built in IC protection - to protect battery from over charger or discharge
  - > Power bank functionality - ideal for an emergency charge of a mobile phone
  - > Magnetic base - for hands-free usage
- |                    |  |
|--------------------|--|
| Light output       | 300 lumens on high<br>150 lumens on low          |
| Battery            | 3.7V Li-ion, 2200mAh<br>8.14Wh                   |
| Functions          | High, low  |
| Operating time     | Up to 4.5 hours on high<br>Up to 10 hours on low |
| Product dimensions | 145 H x 38 W x 38mm D                            |



**DA5088**  
**Ring Zoom 110 Micro Inspection Torch**

- A 110 lumen output with a 6500K colour temperature. With a lightweight and extremely durable aluminium construction, this is ideal for professionals as it can withstand demanding environments. The torch includes a rechargeable li-ion battery, so no need to buy and replace batteries, and a USB to micro USB cable for convenient recharging. The time it takes to charge up a torch is minimal and is extremely time efficient. The torch also includes a 6x optical zoom and wide angle standard setting, for broad illumination or a concentrated beam.
- > Up to 110 lumen torch provides bright white light with 6500K colour temperature
  - > Standard setting has a wide-angle light output for total illumination of the work area
  - > Optical 6 x zoom for a focused beam of light to see into the distance
  - > Complete with USB to micro USB cable for convenient 2.5hr charge time
  - > Aluminium construction designed for every day workshop use
  - > Built in IC protection to protect battery from overcharging or discharge
  - > Magnetic base for hands-free usage
- |             |      |
|-------------|------|
| Voltage     | 3.7  |
| Wattage     | 2.41 |
| Amps output | 650  |



**DA5087**  
**Ring Zoom 150 Duo LED Rechargeable Inspection Torch with LED Strip Light**

- Inspection torch with a 150 lumen output with a 6000K colour temperature. With a lightweight and extremely durable aluminium construction. Ideal for professionals as it can withstand demanding environments. Includes an inspection light for broad illumination. Features a rechargeable li-ion battery using USB to micro USB to recharge it. The torch also includes a 6 x optical zoom and wide angle standard setting, for broad illumination or a concentrated beam.
- > Up to 150 lumen torch provides bright white light with 6000K colour temperature
  - > Standard setting has a wide-angle light output for total illumination of the work area
  - > Optical 6x zoom for a focused beam of light to see into the distance
  - > Torch mode has up to 3 hours of illumination time
  - > Light mode has up to 4 hours of illumination time
  - > Complete with USB to Micro USB cable for convenient recharging (6 hours recharge time)
  - > Aluminium construction designed for every day workshop use
  - > Built in IC protection to protect battery from overcharging or discharge
  - > Magnetic base for hands-free usage
- |                    |                       |
|--------------------|-----------------------|
| Product dimensions | 157 H x 27 W x 27mm D |
| Voltage            | 3.7                   |
| Wattage            | 2.96                  |
| Amps output        | 800                   |



Add some light to your working environment



**DA5095**  
**Ring MAGflex Utility Light**

- Designed with versatility in mind, the MAGflex Utility light combines dual, magnetic ratcheting bases with a 360° rotating body. This means that the light can either be used freestanding or hands-free, positioned in any number of ways to ensure that the workspace is properly illuminated.
- > Rechargeable and cordless ultra-bright 1,000 lumens utility light
  - > Dual 180° ratcheting and 360° twist function to direct light exactly where you need it
  - > Dual hanging hooks and strong magnetic bases for hands free use
  - > Up to 2.5 hour operating time
  - > Mains & 12V DC charging adaptors included
- |                |   |
|----------------|---|
| Light output   | 1,000 lumens on high<br>400 lumens on low |
| Battery        | 7.4V Li-ion, 2600mAh                      |
| Operating time | 2.5h (High) & 5.5h (Low)                  |
| Charging time  | 5hrs                                      |
| Dimensions     | 500 H x 47.5 W x 50mm D                   |
| Voltage        | 7.4V                                      |
| Wattage        | 10W                                       |
| Amps output    | 0.5A                                      |

**Inspection Lights**



**10500050**

**ARB LED Head Light**

- > Up to seven hours run time, the head light
- > Comfortable adjustable elastic head band
- > Adjustable hinge for vertical beam adjustment
- > Focus adjustment for wide or narrow beam
- > Three lighting modes: 300 lumen beam, 180 lumen beam or flashing mode
- > 5W, 6500K Cree LED
- > Runs on 3 x AAA batteries
- > Anodised aluminium body
- > Weight - 162g



**DA5170 NEW**

**Ring MAGflex Headtorch250**

Designed with the professional in mind, the MAGflex Headtorch250 provides reliability where it is needed the most. This 250 lumen headtorch, equipped with a motion sensor, is tested to IP54 & IK07 and operates for up to 6 hours from a single charge. Perfect for all tradesperson, when needing to work hands free.

- > Bright professional inspection lamp - 250 lumens output in a robust housing to withstand tough working environments
- > Integrated motion sensor - convenient control of light output
- > Reliable battery life - up to 6 hours operating time from a single charge
- > Adjustable angle - 60 degree adjustment to point the light where needed
- > Integrated warning features to indicate low battery levels - main light emitting surface and charge level indicator will flash to provide visual warning
- > Type-C USB connection - cable included
- > Light output - 250 lumens (high) & 140 lumens (low)
- > Operating time - 3.5hrs (high) & 6hrs (low)
- > Charging time - 3.5hrs



**Ring MAGflexTwist Ultra Bright LED Inspection Light**

**DA5066**

UK plug

**DA5067**

EU plug

- > Rechargeable and cordless
- > New technology COB LED provides 250 lumens light output
- > Light can rotate 360° with a 180° ratcheting design to allow ultimate directional lighting
- > White light output simulates daylight
- > Wide angle of light output that has uniform intensity
- > Magnet for hands free use
- > Integral hanging hook
- > High power LED torch function
- > Anti slip comfortable grip
- > Li-ion battery for faster consistent recharging
- > Includes AC mains charger

Light output	250 lumens
Battery	3.7v Li-ion, 2200mAh
	8.14Wh
Mains adaptor	Input 230v AC-50/60Hz
	Output 5v DC-500mA



**DA5027**

**Ring Essential LED Inspection Pocket Light**

- > 5hrs operating time
- > Magnet for hands free use
- > LED torch function for focused light output
- > Protective lens for demanding conditions
- > Integral swivel pocket clip
- > Includes batteries
- > Runs on 3 x AAA batteries



Photo by Richard Rushton



**215717**

**Old Man Emu NitroLight Pack**

**Mini LED Light**

- > Compact & lightweight
- > Cordless rechargeable battery
- > 20 LED lights
- > Up to 2 hours run time on full power & 4 hours on half power
- > 12V DC lead and adaptor
- > 400 lumen & 10W output
- > Dual magnetic mounts & single hook mount
- > Water & shock resistant
- > LED life expectancy of 50,000 hours

**LED Head Torch**

- > 5W CREE LED light
- > Aluminium body
- > Three light functions
- > Adjustable elastic strap
- > Batteries included
- > Adjustable beam width
- > Light colour - 6500K



**More information available online**

**10500070**

**ARB Pureview 800 Torch**

The ARB Pureview Torch 800 is a rugged and versatile torch. With a beam distance of up to 300m, this torch provides excellent distance.

**Features & Benefits**

- > 800 lumens
- > LUMINUS® SST40 with 50,000hr life span
- > 300m beam distance
- > 2600mah 18650 li-ion battery
- > High, medium, low & strobe
- > 5000-8300k colour temp
- > 800 lumens high - 1.5 hours runtime
- > 400 lumens medium - 4 hours runtime
- > 200 lumens low - 7 hours runtime
- > Strobe - 20 hours runtime
- > Hidden micro USB charge port internal charging with charge indicator
- > IP55 dust/mud/water resistant

- > Polycarbonate shatter-proof lens
- > Quality braided USB cable
- > Tested to world standard ANSI ratings
- > Aircraft grade anodised aluminium
- > Includes lanyard and magnetic belt pouch
- > Laser etched ARB logos

**Technical**

**Specifications**

- > Beam distance - 300m/984ft
- > Lumens - 800 high, 400 medium, 200 low
- > LED type - LUMINUS® SST40
- > Battery - 3.7V 2600mah 18650 li-ion battery
- > Runtime - 8 hours - low, 4 hours - medium, 1.5 hours - high & 20 hours - strobe
- > IP rating - IP55 (Dust/mud & high-pressure water resistant)
- > Charge time - Up to 4 hours via USB charge cable
- > Accessories - Micro USB high current braided cable, belt pouch
- > Certificates - CE & RCM(SAA)



Photo by Neil Santos



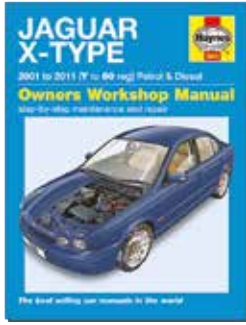

**Owners Workshop Manual**  
**DA3211**

Owners Workshop Manual  
Haynes Jaguar X-Type Petrol & Diesel (01 - 10)



**Roof Bars**  
**DA2314**

Range Rover Classic



**Exhaust Guard Kit**  
**DA2318**

Range Rover L322 - G4



**Hiclone**

Hiclone is a simple non-moving stainless steel device that sits inside the air induction system of an engine. Like a static mixer, it vigorously swirls the air, improving the fuel/air mixture and atomisation, promoting more complete combustion as more of the available fuel is consumed. More efficient burning of the fuel cuts smoke and other hydrocarbon emissions. Hiclone also smooths out the engine torque curve, resulting in a reduction in gear changes and a quieter engine, especially on the motorway. With Hiclone fitted you can corner and go uphill in a higher gear, this makes the vehicle easier to drive, improves the ride and reduces engine wear. Additionally Hiclone improves low down grunt of turbo charged engines making towing and hauling heavy loads more effective.

<b>DA3119</b>	Series 2 - 2.25 - diesel	58mm
<b>DA3126</b>	Defender - 200Tdi - EGR	68 & 45mm
<b>DA3102</b>	Defender - 3.5 carb	2 x (55 x 25mm)
	Range Rover Classic - 3.5 carb	
<b>DA3092</b>	Discovery 1 - 200Tdi	60 & 53mm
<b>DA3128</b>	Discovery 1 - 200Tdi - EGR	60 & 45mm
<b>DA3133</b>	Freelander 1 - 2.0 - diesel	70 & 50mm



**Winch Solenoid**  
**DB1359**

Solenoid 4-pin assembly for old style DB9500 & DB12000 winches

**Headlamp Assembly**

**DA3151**  
24 volt  
Left hand drive



**STOCK CLEARANCE**  
Available while stocks last only. For further details on any of these products, please contact your local Britpart stockist.



**Canvas Bikini Hood - Extended**  
**DA2938**

Defender - 2007 onwards  
Sand



**Winch Magnum 8k 12v Winch**

**DA2261**

Dimensions	532.0 L x 160.0 D x 193.2mm H
Mounting Bolt Pattern	254 x 114.3 mm
Rated Line Pull	3629 Kg
Motor	3.6 Kw
Gear Train Ratio	216:1
Clutch (Freespooling)	Sliding Ring Gear
Brake	Internal Automatic
Drum Diameter/Length	64mm/230mm
Wire Rope	24.4m x 8mm Diameter
Control (Length)	Remote Switch & 3.7m Lead
Recommended Battery	650Cca Minimum For Winching
Battery Leads	2 Gauge/1.83m
Weight	34kg
Fairlead	Hawse
Finish	Black Gloss Powder Coat

Full details online [www.britpart.com/DA2261](http://www.britpart.com/DA2261)



**Fuel Tank Guard**  
**DA2316**

Range Rover L322 - G4



**Roof Bars**  
**DA2321**

Paddy Hopkirk Luggage Rack



**Side Steps**  
**DA4113**

Stainless Steel  
Freelander 1



**Side Steps**  
**DA5642**

Plastic elastomer top with brushed aluminium side trim  
Range Rover Sport - 2005 - 2013



Photo by Bogdan Muscalu



# ENHANCEMENTS



Make Your Land Rover  
Stand Out From The Crowd

Photo by Joe Wakeford



# ENHANCEMENTS

## Defender

### Exterior Enhancements



#### Front Grille & Headlight Surrounds Kit

Defender 2007 onwards

**LR008361** Grille and headlight surround kit

**Note** - Can be fitted to earlier Defenders with some modification.

**VPLDV0001LR** Lights - manual headlight levelling RHD

**VPLDV0003LR** Lights - manual headlight levelling LHD

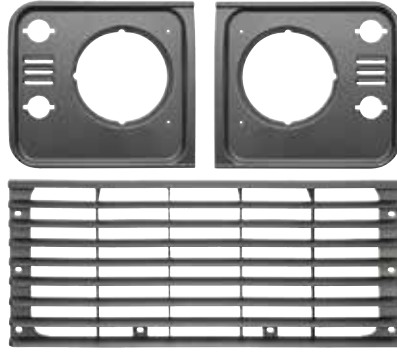

#### Brunel Grey Grille & Headlight Surrounds

**DA1157** Grille & headlight surround kit

**LR038617** Grille

**LR051107** Headlight surround - right hand side

**LR051108** Headlight surround - left hand side



#### DA2356

##### Front Grille

Stainless steel with natural finish

**Note** - Will not fit Td5 vehicles with air-con.



#### Indus Silver Grille & Headlight Surrounds

**DA1257** Grille & headlight surround kit

**LR059125** Grille

**LR059126** Headlight surround - right hand side

**LR059127** Headlight surround - left hand side



#### Santorini Black Grille & Headlight Surrounds

**DA1357** Grille & headlight surround kit

**LR051771** Grille

**LR059128** Headlight surround - right hand side

**LR059129** Headlight surround - left hand side



#### DA2356B

##### Front Grille

Stainless steel with black finish

**Note** - Will not fit Td5 vehicles with air-con.



#### DA1968

##### XS Front Grille & Headlight Surround

Black with silver mesh

Stainless steel screw sets - DA1169 x 2 & DA1138



#### DA1969

##### XS Front Grille & Headlight Surround

Silver with black mesh

Stainless steel screw sets - DA1169 x 2 & DA1138

**Enhance** the look of  
your Defender



#### DA6551

##### Lower Grille

Stainless steel lower grille for air-con models.

Includes fixings.



#### DA6552

##### Lower Grille

Stainless steel lower grille for non-air-con models.

Includes fixings.



#### DA2976 NEW

##### Rear Light Trim Kit

Defender - 2020

Dark Grey

Protect your rear light cluster panels with a pair of these easy to fit trim pieces. Made from a rubber composition with a chequer plate design, they simply fit in place over the existing panel.

**Exterior Enhancements**



**XS Air Intake Grille**  
 Black with silver mesh  
 Stainless steel screw sets - DA3999  
**DA1970** Right hand side  
**DA1972** Left hand side



**XS Air Intake Grille**  
 Silver with black mesh  
 Stainless steel screw sets - DA3999  
**DA1971** Right hand side  
**DA1973** Left hand side



**Snow Cowls**  
 Manufactured from ABS plastic these cowls will help prevent snow, mud and leaves from entering the heater intake and reducing the Defender heater performance. Fitting a cowl will reduce moisture build-up in the intake system which can happen if debris collects in the one-way valve. The cowl fits over the existing grille and follows the profile of the Defender's wing.  
**DA1270** Left hand drive  
**DA1271** Right hand drive



**Bonnet Vent**  
 Stainless steel. Includes stainless steel screw kit  
**DA4000SS** Left hand side  
**DA4001SS** Right hand side



**Bonnet Vent**  
 Steel - black. Stainless steel screw kit - DA4000-1FK  
**DA4000** Left hand side  
**DA4001** Right hand side



**DA1974**  
**XS Bonnet Vent**  
 Black with silver mesh  
 Stainless steel screw kit - DA4000-1FK



**DA1975**  
**XS Bonnet Vent**  
 Silver with black mesh  
 Stainless steel screw kit - DA4000-1FK



**DA1966**  
**XS Snorkel Head**  
 An easy to install enhancement for any Safari or Britpart snorkel. Compliments the Britpart XS range of air vents and grilles.



**DA6903**

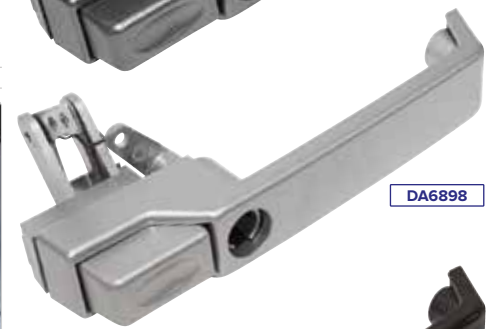

**DA6898**



**DA6895**

**XS Door Handles**

<b>DA6903</b>	Brunel	RHS	Equivalent to MXC7652
<b>DA6902</b>	Brunel	LHS	Equivalent to MXC7651
<b>DA6898</b>	Silver	RHS	Equivalent to MXC7652
<b>DA6897</b>	Silver	LHS	Equivalent to MXC7651
<b>DA6895</b>	Gloss black	RHS	Equivalent to MXC7652
<b>DA6894</b>	Gloss black	LHS	Equivalent to MXC7651



**DA1963**  
**Puma Bonnet**  
 White  
 This Puma GRP bonnet is half the weight of the original Land Rover bonnets and will fit Defender 90 - 1984 onwards & Defender 110 -1983 onwards. The bonnet has return edges on all four sides underneath for strength and to make it more rigid. It has strengthened hinge points and is supplied with stainless steel hinge bolts & screws.



# ENHANCEMENTS

## Defender

### Exterior Enhancements



**DA6892**  
**XS Wing Mirror**  
Black backing Single - excludes arm



**DA6893**  
**XS Wing Mirror**  
Silver backing Single - excludes arm



**DA6900**  
**XS Wing Mirror**  
Brunel backing Single - excludes arm



**DA6901**  
**XS Wing Mirror**  
Primer backing  
Single - excludes arm



**DA7637**  
**Black & Chrome Union Jack Badge**  
With self adhesive foam backing. 51 x 29mm. A great edition to the exterior of any Land Rover.



**DA7638**  
**Black & Chrome Union Jack Oval Badge**  
With self adhesive foam backing. 70 x 37mm. A great edition to the exterior of any Land Rover. Exact fit for the side window panel of the Defender 2020.



**Enhance** the look of your Defender



**DA1179**  
**Bulkhead Vent Hinge Pin Kit**  
Stainless steel  
4 hinge pins



**DA1142**

**DA1142B**



**DA1142SS**

**Windscreen Brackets**  
Supplied in pairs  
**Anodised Finish**  
Replace your corroded Defender windscreen brackets with a pair of these smart CNC machined aluminium billet brackets which won't tarnish like the standard brackets. Kits include gaskets and bolts. For fitment to vehicles with hinge type windscreen 2 x reinforcement strap LR016671 are required.

**DA1142** Silver anodised finish

**DA1142B** Black anodised finish

**Stainless Steel**

**DA1142SS**

These are cast from marine grade 316 stainless steel and polished. Complete with fixings.



**DA1152B**

**DA1152**



**Bonnet Hinges**

Supplied in pairs

**Anodised Finish**

Replace your corroded Defender bonnet hinges with a pair of these smart CNC machined aluminium billet hinges which won't tarnish like the standard brackets. Kits include hinges, hinge bushes and stainless steel bolts.

**DA1152** Silver anodised finish

**DA1152B** Black anodised finish

**Stainless Steel**

**DA1152SS**

These are cast from marine grade 316 stainless steel and polished. Complete with fixings.

Britpart have a wide range of replacement door hinges. For more information on these kits, turn to the chassis and body section.

### Exterior Enhancements

#### Mudflap Brackets

<b>DA1188</b>	Defender 90 & 110	Front - equivalent to MTC3000 & MTC3001	Galvanised	Pair
<b>DA1187</b>	Defender 90	Rear - equivalent to MUC3986 & MUC3987	Galvanised	Pair
<b>MTC3000SS</b>	Defender 90/110/130	Front - right hand side	Stainless steel	
<b>MTC3001SS</b>	Defender 90/110/130	Front - left hand side	Stainless steel	
<b>MUC3986SS</b>	Defender 90	Rear - right hand side	Stainless steel	
<b>MUC3987SS</b>	Defender 90	Rear - left hand side	Stainless steel	

These brackets can also be used with CAT500360PMA & CAT500370PMA as replacement brackets. These brackets are not available as stand alone brackets - they are only available to order along with the mudflap. The universal number for the mudflap for all Defender 110/130 rear applications is BTR277.

<b>CAT500340PMASS</b>	Defender 110/130	Rear - right hand side	Stainless steel
<b>CAT500350PMASS</b>	Defender 110/130	Rear - left hand side	Stainless steel



For many more lighting enhancements turn to our extensive range in the Lighting section.



**XFC100550CH**  
Number Plate Light  
Chrome



**XGB100310L**  
Indicator Light With Orange Bulb  
Defender - 2007 onwards Clear Single



**Rubber Bumper End Cap**  
**DPT100070** Single - Does not include fixings DZM100080  
**DA8601** Pair - Includes fixings



**DA5699**  
Universal Number Plate Mounting Bracket  
405 W x 110mm D  
Black finish Single  
Number plate not included.

**LR062058S**  
Front Bumper  
Silver finish

#### Front Bumpers with Running Lights

These smart and functional standard fit Defender bumpers are equipped with a pair of LED lights for additional lighting in the dark or day light running for safety. More information in the Lighting Section.

<b>DA8600</b>	Ring LED lights
<b>DA8600XS</b>	Ring LED lights and rubber end caps
<b>DA9500</b>	LED lights
<b>DA9500XS</b>	LED lights and rubber end caps



**VPLEP0447LR**  
Rear Scuff Plate  
Defender 2020 - 90 & 110  
Stainless steel



**VPLEP0517LR**  
Anti-glare Bonnet Decal  
Defender 2020 - 90, 110 & 130  
Matt black self-adhesive anti-glare bonnet decal

**DA5084**  
'Spectre' Rope  
> Give your Defender the 'Spectre' look with this rope  
> 4.5 metres long  
> Cosmetic use only



**DA4980 NEW**  
Defender - 2020 onwards  
Gloss black spoiler



**VPLEP0542LR NEW**  
Exterior Side-Mounted Gear Carrier  
Provides easy access storage on the outside of the vehicle. Designed for aerodynamic performance & to minimise wind noise. Tested for harsh environments. Compatible with the radio antenna, however metallic objects inside the gear carrier may affect radio performance. Lockable, waterproof and perfect for carrying walking boots, wetsuits or other items that you may prefer not to carry inside your vehicle.



### Electrical Enhancements



**DA6678**  
**USB Extension Socket**

Replace that loose USB input cable trailing from the back of your head-unit in your Land Rover with a dedicated dash-mounted USB input socket. The MUD USB Extension socket provides a neat way to connect to any head-unit equipped with a Apple CarPlay/Android Auto by connecting the USB via the rear of the head unit. The MUD USB Extension socket is equipped with a Male USB A connector to plug directly into the Female USB A socket/lead on the back of your head unit. Plug your phones power lead directly into the MUD USB Extension Socket on your Land Rover dashboard to provide Android Auto or Apple CarPlay connectivity and simultaneous phone charging. Length of extension lead is 1000mm. Musical note illuminates green when powered by the vehicle. Finish of rocker is black. The USB Extension socket is styled to complement the original Land Rover Td5/Tdci switch design. The USB Extension socket will slot into the factory switch apertures on the Defender Td5 & Tdci dashboards. The MUD Land Rover USB Extension socket will also fit the apertures within the Freelander 1 & Discovery 2 & 'Soft-Dash' Classic Range Rover. It will also fit the MUD Puma Pod II & any Puma Double DIN Console switch relocation panels. The green illumination of the USB is a brighter green than the factory LED illumination. If this is problematic for you, you can remove the rocker from the USB rotate the switch round then re-apply the rocker. This stops the musical note from illuminating when powered.



**DA6674**  
**USB Socket**

Designed by MUD to slot into the factory switch apertures on the Defender -Td5 & Puma dashboards. The MUD Land Rover USB socket will also fit the apertures within the Freelander 1, Discovery 2 & Range Rover Classic 'Soft-Dash'. The socket design and green background illumination complements the original OEM Land Rover switches and helps the install retain a factory appearance. USB (A) socket is 12v Quick Charge (QC) 3.0 rated. Supplied with a mini-harness to provide a simple two wire installation. Fitting instructions included.



**DA7481**  
**Voltmeter Gauge**

Defender  
- up to 2006  
Defender -  
2007 onwards with  
additional pod



**DA3237**  
**Binnacle Switch Pod**

Defender 2020  
These switch pods were designed to blend into the dash and allow for 2 switches. The pod is supplied with two switches and is made from durable ABS plastic that easily mounts into position using the included double-sided tape.



**DA4664**

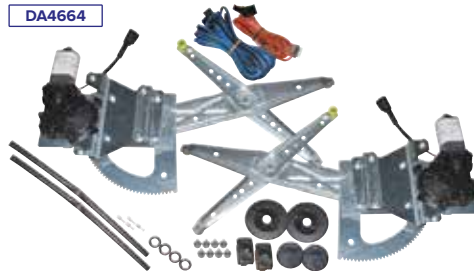

**DA4664**  
**Electric Front Window Kit**

Defender - 2002 onwards  
Fed up with winding your windows up and down?  
Make life easier, add electric front windows to your Defender with this comprehensive kit. Includes fitting instructions.  
Replacement motor for electric window kit DA4664

**DA4664MOTORRH** Right hand side  
**DA4664MOTORLH** Left hand side

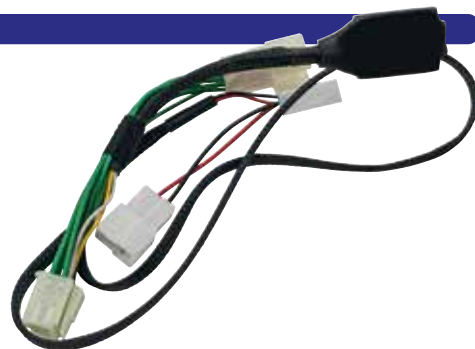

**DA2868**  
**Defender One Touch Indicator Upgrade**

Defender - from late 300Tdi to current 2016 -2.2TDCi  
This complete plug and play upgrade adds the functionality of new vehicles equipped with lane change or 3 flash indicators to your Defender. With a simple momentary press of the indicator stalk the indicators will flash 3 times.  
**Note** - Please check on 300Tdi models you have the later style wiring connectors to confirm this you will need to remove the lower steering cowl.

**DA2882**



**DA2882**  
**Ultra-compact Subwoofer**

The Z880 is an 8-inch, ultra-compact, fully aluminium subwoofer from Phoenix Gold. It is designed to fit into a variety of small spaces within any vehicle, including under seats or limited boots. The powerful MOSFET amplifier delivers 80Watt RMS and up to 240W maximum. The Z880 is a plug & play unit with a complete wiring kit for high-level installation. The wiring kit includes power, ground and high-level input quick connectors and includes a wired bass remote. The design of the subwoofer is up to 60% smaller than a standard under seat subwoofer.

- > 8" Active ultra Ultra compact subwoofer
- > 80W RMS 240W Max
- > AutoStart on high-level input
- > Remote gain control
- > High and low level input
- > Power & high-level cable quick connector
- > Aluminium casing
- > Subsonic filter at 20Hz
- > Phase control
- > Variable Bass boost 0-12 Boost
- > Dimensions - 290mm x 210mm x 70mm



Join our regular newsletter  
[www.britpart.com/newsletter](http://www.britpart.com/newsletter)



**DA4874 NEW**  
**Electric Rear Window Kit**

Defender - 2002 onwards  
Fed up with winding your windows up and down?  
Make life easier, add electric rear windows to your Defender with this comprehensive kit.



Britpart

Electrical Enhancements



**DA6554**  
**LED Interior Light**  
Light grey  
Defender - 1991 onwards

MUD has worked in conjunction with one of the UK's leading automotive lighting manufacturers to create a 100% British designed and manufactured product that uses only the highest quality components. The MUD LED Interior Light utilises ceramic LED technology to provide 18 x more usable light than the traditional festoon bulb design and with a rating of 228 lumens is 400% brighter than the factory fitted Land Rover interior light. With a colour temperature of circa 6,000K, the LED light output falls into 'daylight' classification providing better colour rendition, i.e. colours look more true to life. Another neat feature of the MUD LED Interior light is the switchable white to red illumination function for improved night-time vision. Plug & Play connection with fixings supplied. The MUD Interior LED Light will replace both front and rear interior lights in the Land Rover Defender. Rear Station Wagon fitment requires the use of the optional MUD LED Light plinth - DA6555. These lights will fit the Defender roof consoles - DA4629 & DA4629B.

**DA6555**  
**LED Interior Light Plinth**  
Light grey  
Defender - 1991 onwards

The MUD LED interior light plinth allows you to fit the popular MUD LED light to the rear of a Defender Station Wagon. The plinth gives enough room to allow the light to fit to the existing wiring. Please note the plinth is not required when fitting to the front of the vehicle.

**DA2343L**



**KEEP COOL**

**Air Conditioning Kits**

**Front Kits**

<b>DA2343R</b>	Defender 90/110 - 300Tdi	RHD
<b>DA2343L</b>	Defender 90/110 - 300Tdi	LHD
<b>DA2342R</b>	Defender 90/110 - Td5	RHD
<b>DA2342L</b>	Defender 90/110 - Td5	LHD
<b>DA2344</b>	Defender 90/110 - 2007 onwards	RHD & LHD

As OE fitment. Once fitted the system is indistinguishable from factory fitted units. Plugs straight into the existing Land Rover wiring loom and fuse board. Easy to install as components are pre-assembled. Kit uses high performance condenser which eliminates need for an extended nose cone. Parts interchangeable with Land Rover parts.



**DA4598**  
**Heated Mirror Kit**

MUD-UK Defender heated mirror elements are unlike any other heated mirror element. They use the same carbon impregnated glasscloth technology found in underfloor heating and high-end bathroom mirror applications. Unlike traditional printed circuit heated mirror elements the current flow in flexible glasscloth is across the whole surface area of the element. This results in a larger 'heated' surface area and avoids the "striping" effect of traditional elements. The mirror elements have no fine circuits which can damage easily and offer improved durability and performance over traditional printed circuit elements. The heated mirror elements are supplied with self-adhesive backing. Peel off the backing and stick the element to the back of the Defender mirror glass. Also supplied with a fitting kit that consists of 4m of twin core wire, assorted terminals and a relay. To allow the installer to match up existing switches already installed, an additional switch is required which is not supplied. The wiring can be concealed within the arm of the wing mirror, to create a neat and tidy finish. Elements measure 115 x 167mm.



**DA5717**

**Retrofit Insert Seat Heaters**

- Complete set for driver and passenger seats
- > Two stages of heating
  - > Kit includes four heating elements and items needed for installation
  - > Pre-assembled cable set with switching relay and buttons included
  - > Temperature guard to prevent overheating
  - > Heating elements are durable and extremely flexible
  - > For use on seats which have a removable cover
  - > Includes fitting materials and instructions
  - > Test mark: e-approved to 95/54/EC (EMC guidelines for vehicles)

Full details in the Seats & Trim section

**DA5717W**

Waeco retrofit insert seat heater  
See [www.britpart.com/DA5717W](http://www.britpart.com/DA5717W) for full details



**Rear Kit**

**DA3263 NEW**

Defender 110/130 - 2007 onwards RHD & LHD  
The rear A/C unit includes a central cubby box designed to house the air conditioning components, this cubby box comes fully assembled and is a drop-in replacement. The unit design incorporates a new floor plate for the vehicle, replacing the original floor plate that is beneath the cubby box or third seat if fitted. The rear A/C unit consists of twin blowers, with 3D printed components for improved drainage, ducting and airflow. This is combined with a large evaporator coil, suitable for cooling long wheelbase Defenders. The unit features a cigar lighter, providing a 20A outlet for high power accessories. Improvements have also been made to the mechanical components such as the cup holders, these are now machined from billet aluminium prior to finishing.





### Electrical Enhancements



**DA4698**

#### 12 Volt Dash Socket

Features watertight cap, easy installation and twist locks securely with plug

- > Designed to withstand the rigours of damp environments and constant vibration
- > Large contact surfaces for good electrical connection
- > Twist lock system - plug locks securely into socket
- > Internal strain relief and cord seal
- > Nickel plated copper alloy used for all current carrying components
- > Front panel, rear panel or surface mount

#### Specifications

Maximum voltage - 12V DC  
Cut-out dimensions - 1 1/8" (28.58 mm) diameter hole  
Maximum socket amperage - 15A



**DA4679**

#### Dual USB Charger

Easy to install in existing 12V DC socket hole providing convenient access for charging mobile devices.

- > Compatible with popular mobile devices
- > Protective cap
- > Easy to use

Maximum output current - 2.1A DC (total)  
Cut out dimensions - 1 1/8" (28.58 mm) diameter hole  
Input voltage - 12V  
Output voltage - 5V DC +/- 5%  
Parasitic current draw - 15mA  
USB - 2.0



**LR058447**

**DA1401**



#### Heated Windscreen Components

Make scraping your Defender's windscreen on a frosty morning a thing of the past by fitting one of these kits.

- DA1400** Carling Contura switch kit
- DA1401** Land Rover switch kit
- DA1406** Harness fleece tape - 19mm x 25m
- LR058447** Tinted heated windscreen

For more details and technical information on these kits - [www.britpart.com/heated](http://www.britpart.com/heated)

## Enhance the look of your Defender



**DA1748**

**DA1748**

#### 6-Way Blade Fuse Distribution Block Neg Bus Bar

This high quality 6-way fuse holder distribution block has an integral 6-way bus bar - meaning both live and earth connections can all be made at this fuse panel.

- > A clear insulating cover is supplied which also has slots to hold spare fuses within the cover
- > Externally on the cover are recesses to mount small format stickers to identify the circuits protected
- > Selection of stickers provided
- > Accepts ATO & ATC automotive blade style fuses
- > Tin plated bus and fuses connections for superior corrosion resistance
- > Mounts via four M4 holes
- > Positive and negative posts are M5 size
- > Each circuit is rated at 30 amps at a maximum of 32 volts with a total rating of 100 amps per block

1 x 6-way blade fuse distribution block with neg bus bar

#### ATO/ATC Blade Fuses

- 1 x 5a blade fuse - beige
- 1 x 10a blade fuse - red
- 1 x 15a blade fuse - blue
- 1 x 20a blade fuse - yellow
- 1 x 25a blade fuse - clear
- 1 x 30a blade fuse - green

#### Pre-insulated Ring Fuse Blocks

- 6 x Red M4
- 4 x Blue M4
- 2 x Yellow M4
- 2 x Blue M5
- 2 x Yellow M5



**DA1404**

#### Five Way Switch Housing

##### Connector Plugs

- DA1402** Black
- DA1403** White
- DA1404** Blue
- DA1405** Green



**DA1922**

#### Fast Rings

Defender - and other 5" / 5 1/4" speakers  
A 3-piece foam ring speaker enhancement system solves the problem of acoustically coupling aftermarket speakers to factory speaker openings. The RoadKill Fast Rings kit increases speaker output, improves the projection of the audio into the car cabin and reduces unwanted rear reflections that can degrade the sound.

#### Benefits

- > Reduce panel vibration
- > Increase mid-bass response
- > Enhanced audio output efficiency
- > Minimize destructive wave interference
- > Help prevent front and rear wave cancellation
- > Easy installation with peel & stick application
- > Maximize performance for speaker installations
- > 3-Ring DNA
- > Gasket for speaker mounting to the baffle plate surface
- > Middle ring to mount around the outer edge of the speaker
- > Circular foam pad goes behind the speaker to absorb unwanted reflections on hard surfaces, such as inside a car door



**DA7960**

#### Ring Wireless Connect

The smart way to control power to ancillary electrical products. The one central Tech Hub connects to the vehicle's 12V battery, allowing 8 ancillary electrical products to be wired to one location. Then through unique signal pairing each device can be wirelessly accessed through the switch remote.

- > One power pick up point
- > Single point connection for up to 8 ancillary products
- > Ease of product connection
- > Driving efficiencies and saving time in both fitting and operation
- > Removes the need to fit battery protection measures
- > A simple system, reducing faults and keeping vehicles in operation
- > The switch unit can be operated remotely on the job
- > Switch units can be located anywhere in the vehicle for easy access

With fewer connections and one central wiring point, fault finding is simpler and vehicles can be back in operation quickly. The switch remote can be located anywhere on the vehicle and can be operated remotely during on-site working.

- > Single point connection for efficient installation
- > 60 amp capacity, powerful enough to operate multiple ancillaries at the same time
- > Unique signal pairing allowing x 2 switch panels to be connected
- > 8 fused output channels for easy connection for ancillary electrical products
- > Manual override in case of an emergency
- > Battery protection maintains battery voltage
- > Switch remote - Single point switch panel where 8 switches are controlled via one user interface
- > Switch remote - Backlit illumination for working at low light
- > Switch remote - Active channel lights indicates switch status icon
- > Switch remote - Lithium battery for quick efficient recharging
- > Switch remote - Adaptable switch icons to suit individual requirements
- > Switch remote - Docking station for secure fitment when travelling or recharging

#### Specifications

Input voltage 11 - 15V  
Input current Max 60A  
Battery protect voltage cut-off 11V  
Input reverse voltage protection Up to 16V  
Fused input 60A  
8 x Fused relay channels 2 x 1.5A; 2 x 3.5A; 2 x 5A & 2 x 20A

#### Tech Hub

You can connect up to 8 ancillary products to our hub and each one is then wirelessly accessed through our switch keypad. The hub can be conveniently located in the vehicle to minimise wiring and fitting times and to give operators easy access.

#### Switch Remote

The switch unit wirelessly connects to the hub, can be removed from the dock to be operated remotely on the job and can be located anywhere in the vehicle.

More information & images can be found online at [www.britpart.com/DA7960](http://www.britpart.com/DA7960)

### Interior Enhancements



#### Interior Side Door Handles

<b>DA8935</b>	Black anodised aluminium	Single
<b>DA8936</b>	Silver anodised aluminium	Single

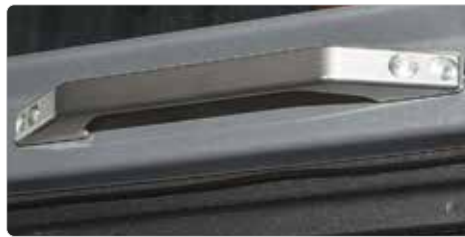

#### Rear Grab Handles

<b>DA8937</b>	Black anodised aluminium	Single
<b>DA8938</b>	Silver anodised aluminium	Single



#### Door Lever Surrounds

<b>DA8953</b>	Black anodised aluminium	Pair
<b>DA8954</b>	Silver anodised aluminium	Pair



#### Vent Knobs

Defender - up to 2007

<b>DA8947</b>	Black anodised aluminium	Single
<b>DA8948</b>	Silver anodised aluminium	Single



#### Heater Control Knobs

Defender - up to 2007

<b>DA8945</b>	Black anodised aluminium	Single
<b>DA8946</b>	Silver anodised aluminium	Single



#### Fuse Box Screws

Defender - up to 2007

<b>DA8949</b>	Black anodised aluminium	Single
<b>DA8950</b>	Silver	Single



#### Locking Pegs

<b>DA8943</b>	Black anodised aluminium	Single
<b>DA8944</b>	Silver anodised aluminium	Single



#### MTC2640A

#### Switch Mounting Panel

Defender - up to 1A999999

Black aluminium switch mounting panel. Excludes switches.



#### DA4599

#### Heater Deflector

Defender - 2007 onwards

The MUD Heater Deflector solves the problem of that crude and annoying blast of hot air to your lower legs in all Puma engine Defenders. The Heater Deflector redirects the flow of air from the lower heater outlets forwards into the footwell, rather than directly at your legs to create a more comfortable driving environment. The Heater Deflector moulding fixes easily in place using the supplied push-fit fasteners & can be fitted in 5-minutes. All you need is a 4.5mm drill. Position Heater Deflector, drill the fixing holes in the lower dash section & fix the Heater Deflector in place using the push-fit fasteners.



#### DA4691

#### Single DIN Dashboard Mount

Defender - 2007 onwards

The MUD dashboard mount creates a quick and easy method of mounting a single DIN accessory into the Puma dashboard. You will however have to route any wiring through the back of the dashboard. Ideal for mounting any DIN sized CB/HAM radio unit into your Defender. Mic extension leads are an inexpensive accessory and commonly available so that mic can reach the driver. The single DIN mount also comes with a handy 'coin tray' which sits behind the grab handle. The dashboard mount is also suitable as a digital tachograph mount. EU customers should be aware that mounting a tachograph on the passenger side of the dashboard does not meet EEC legislation. Supplied with all fixings required to provide a quick and easy installation. Fits both right-hand drive and left-hand drive vehicles.



#### Front Grab Handles

<b>DA8868 NEW</b>	Black anodised aluminium	Single
<b>DA8869 NEW</b>	Silver anodised aluminium	Single

Defender - 1987 - 2006

Make getting in and out of your Defender easier with these smart, easy to fit anodised aluminium A-pillar grab handles. Supplied with fixings.



#### DA1205

#### Demister Kit

Defender - 1987 - 2007

Fitting this Defender demister kit will help demist your windscreen more effectively than the standard fitted demister and has the added bonus that it will also demist your side windows too. With full fitting instructions.



# ENHANCEMENTS

## Defender

### Interior Enhancements



DA4790



DA4791



DA4792



DA4793



DA4794

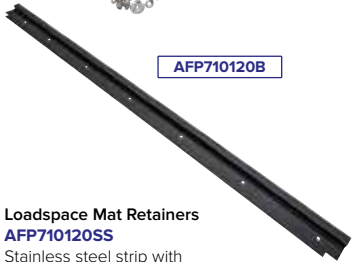

AFP710120B

#### Loadspace Mat Retainers

##### AFP710120SS

Stainless steel strip with stainless steel fixings

##### AFP710120B

Black strip

#### Stainless Steel Door Threshers

Defender - from 1983 onwards & Series 2 & 3  
These stainless steel door threshers will freshen up the inside of your Land Rover as this is an area which can get very scruffy. All of the existing holes on the sills line up with these doors threshers so they are a quick, easy bolt on project. The door threshers are made from stainless steel 304 grade bright annealed 1.5mm thick and are laser cut and CNC pressed. Stainless steel fixings are supplied.

**Note** - If your door seal is fitted to your sill rail, you may need to modify the sill rail.



AFP710120SS

#### Front & Rear Doors

##### Stainless Steel DA4790

Front door threshers

For vehicles without sill seat belt mounts

##### DA4791

Front door threshers

For vehicles with sill seat belt mounts

##### DA4792

2nd row door threshers

##### Brushed Stainless Steel DA4790B

Front door threshers

##### DA4791B

Front door threshers

For vehicles with sill seat belt mounts

##### DA4792B

2nd row door threshers

#### Front & Rear Door Kits

##### Stainless Steel DA4793

Front & 2nd row door threshers

For vehicles without sill seat belt mounts

##### DA4794

Front & 2nd row door threshers

For vehicles with sill seat belt mounts

##### Brushed Stainless Steel DA4793B

Front & 2nd row door threshers

##### DA4794B

Front & 2nd row door threshers

For vehicles with sill seat belt mounts



DA4871

#### Stainless Steel A-Post Trim

DA4871 Stainless steel Pair

DA4871B Brushed stainless steel Pair

The A-Post Trims are designed to replace the existing trim and will cover the corner where they normally tear. The door threshers are made from stainless steel 304 grade bright annealed 1.5mm thick and are laser cut and CNC pressed. Includes fixings.



#### Seat Box Protectors

##### DA7370 NEW

Brushed stainless steel

##### DA7371 NEW

Black steel

Defender Pair

The edge of the Defender seat box is prone to damage, protect that edge and smarten up your interior with these protectors. Made from 2mm steel. Less than 5 minutes to fit and all you need is a drill for the fixings. Kit includes a pair of corner protectors and 8 no. 8 x 19mm flanged steel self drill fixings. These will also fit a Series 2 & 3 but will require matching drilling to accommodate seat rail fixing.



#### VPLE0572PVJLR

##### Loadspace Treadplate

Defender 2020 - 90 & 110  
Stainless steel



DA4871B

**Enhance** the look of your Defender

#### DA5051

##### Gear Lever Set

Defender - 2007 onwards

A great replacement for your standard Defender gear lever. These gear levers are easy to fit with no modifications required. Just remove the plastic from the existing levers and swap with these high quality replacements.



#### DA1472

##### Gear Lever Set

Defender - 2007 onwards

Enhance your vehicle's interior with a set of these leather cover gear levers. Easy to fit.



DA5500

DA6600

#### Gear Lever & Transfer Gear Lever Sets

Anodised alloy

DA5500 R380 gearbox

DA6600 LT77 gearbox



Interior Enhancements



**DA2975 NEW**  
Aluminium Pedal Kits

Defender - 2020  
Enhance your Land Rover's interior with these smart looking brake and accelerator pedals. Featuring a rubber anti-slip design, they are easy to fit. Simply remove the existing pad and replace with these. Suitable for both right and left hand drive vehicles.

**Billet Aluminium Pedal Covers**

- DA8857 NEW Silver
- DA8858 NEW Black
- DA8859 NEW Grey

Defender - Td5 & Tdci  
Designed and manufactured by Optimill, these are CNC machined from billets of aerospace grade 6082-T6 aluminium. Rubber grips fitted to aid grip and feel of the pedal. After machining, they are ceramic blasted and anodised to a maximum of 25 microns. Set of 3.



Photo by Dariusz Smereczynski



### Interior Enhancements



#### DA6493

##### X-Trouser - Pair

Lost a pair of trousers getting in and out of your Defender? Here is the simple solution. Not only does it protect your trousers, in many cases it makes the door close more reliably and helps (though it does not entirely stop) the seat belt getting caught in the latch. If the seat belt does become caught as you close the door, it suffers less damage due to the smooth profile of the X-Trouser. The X-Trouser has a smooth profile, if your belt loop or pocket runs over it, it will slide off freely. Made from high quality 304 grade stainless steel. The X-Trouser catch is reversible so it will fit both the driver and passenger doors, left & right hand drive. It will also fit the rear side doors of 110 Station Wagons.



##### Double DIN Fascia Plate

- DA2608** Piano gloss black
- DA2609** Matte black

Defender - 2007 onwards

This fascia kit allows the installation of a double DIN head unit into a non-double DIN size aperture. High quality finish designed to match the vehicle dashboard. Complete fascia kit, supplied with brackets to mount the aftermarket double DIN head unit.

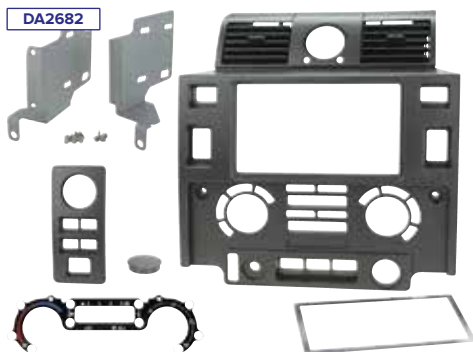

##### Double DIN Fascia Plate With Retention Of OEM Clock

- DA2681** Piano gloss black
- DA2682** Matt black

Defender - 2007 onwards

For double DIN stereo installation. Retains OEM clock, all dash buttons and button detail. Fascia kit allows the installation of an aftermarket head unit into a non-DIN sized aperture. High quality finish designed to match the vehicle dashboard. Allows for relocation and retention of OEM clock. Fascia kit supplied with brackets or cage if required.



#### Rear Door Stays

**DA1204** Defender - up to 2002

**DA1203** Defender - 2002 onwards

Does your Defender's rear door sometimes close on you unexpectedly? This neat and easily installed gas strut kit will solve that problem and replaces the original door stopper. The gas strut will hold the door in place when open - even with a spare wheel in place - and will assist in the opening of the rear door too with a smoother and more controlled movement. Complete with fittings and instructions.

#### DA8958

##### Blanking Plug

Replace your old or lost 12V cigar lighter blanking plug with this smart chrome topped one.



#### DA2898



#### Seat Belts

Add a splash of colour to your Defender's interior by fitting a set of these red seat belts. Type approved.

- DA5055** Defender - truck cab  
Right hand side - equivalent to BTR6562
- DA5056** Defender - truck cab  
Left hand side - equivalent to BTR6561
- DA5057** Defender - station wagon  
Front - equivalent to BTR6563
- DA5079** Defender - station wagon - Td5 onwards  
Front - right hand side
- DA5080** Defender - station wagon - Td5 onwards  
Front - left hand side
- DA5058** Defender - station wagon  
Rear - equivalent to EVL501580
- DA5059RH** Defender 110 - 2007 onwards  
Crew cab pick up - non-hi-cap  
Rear outer - right hand side  
Equivalent to EVL501600PMAG
- DA5059LH** Defender 110 - 2007 onwards  
Crew cab pick up - non-hi-cap  
Rear outer - left hand side  
Equivalent to EVL501610PMAG
- DA5060RH** Defender 110 - From YA183533 - 2007  
Crew cab pick up - non-hi-cap  
Rear outer - right hand side  
Equivalent to EVL000080PMAG
- DA5060LH** Defender 110 - From YA183533 - 2007  
Crew cab pick up - non-hi-cap  
Rear outer - left hand side  
Equivalent to EVL000090PMAG



#### DA1170

##### SVX Style Cargo Tie Down Point

Smart and easy to fit

Single



#### Defender Td5 Double DIN Console

**DA2898** Black

Corresponds to single DIN - FWJ000110PMA

**DA2899** Brunel Silver

Corresponds to single DIN - FWJ000110LQV

The MUD Td5 Double DIN Console replaces the factory-fit Defender Td5 radio fascia with an exclusive one-piece design that allows you to easily upgrade the original single DIN radio set-up to a double DIN head unit. The original radio fascia fitted is a fragile unit prone to breakage thanks to a flimsy and poorly designed two-piece assembly that can barely support the weight of the single DIN head unit. Typically, the separate centre panel containing the head unit/radio will break loose from the main console. Fitting is a simple DIY upgrade that uses the factory fixings and requires no cutting, drilling or modifications to be made to your dashboard. Simply remove your old console, replace with the new console and enjoy the benefits and features of the larger screens found on modern double DIN head units. The console was engineered using CAD 3D scanning technology and uses an injection moulded manufacturing process for a factory fit appearance and a perfect fit every time. A design detail we've incorporated is to increase the diameter of the recess that houses the standard cigar lighter style 12v socket. This increase in the recess diameter has been made to accommodate the popular Blusea marine grade power sockets.



### Interior Storage & Panels



**DA1470**  
**Heavy-duty Drawer Systems**  
 Defender 90  
 Defender 110 - Utility 2007 onwards

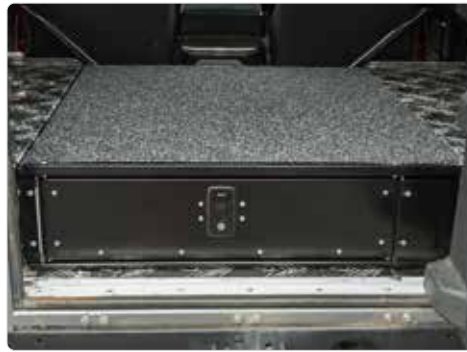

**DA1471** Defender 110

Drawer size - 950 x 700 x 170mm  
 Overall dimensions - 1,100 x 910 x 230mm  
 Base - 1,000mm long  
 Drawer size - 1,010 x 700 x 170mm  
 Overall dimensions - 1,160 x 910 x 230mm  
 Base - 1,050mm long

These Defender drawer systems are ideal for storing items that you keep in your vehicle that you would want to be hidden away from view and can be locked for extra security. The heavy-duty drawers with smooth roller action, fit between the wheel arches and create very useful extra storage space. Drawers extend almost full length for ease of access with a maximum load of 80kg. Hard wearing textured black finish complements the heavy-duty carpeted top.

**Note** - Will not fit 90 Station Wagons or 110 Station Wagons with 3rd row or inward facing rear seats.



Image above shows side floor kit fitted. Custom box and cover not included in package. Image below shows both single drawer module and side floor kit



#### CRDDEF

#### ARB Outback Solutions Modular Roller Drawers

Single Drawer Module  
 Defender - 90 & 110 Station Wagon - 2002 - 2016  
 The ARB Outback Solutions Modular Roller Drawers have unique and practical features incorporated into their design to ensure high quality, maximum functionality and ease of use.

#### Specifications

Drawer Internal - 730mm wide x 970mm long x 220mm high  
 External Frame - 790mm wide x 1,070mm long x 280mm high  
 Total Weight- Approx. 63kg

- > **Anti-roll Back System** - Incorporates mechanisms on the roller drawer that lock it in the open position, preventing unintentional closing when the vehicle is on uneven ground. The mechanisms engage at full opening of the roller drawer and are disengaged automatically when closing.
- > **Anti-rattle** - Locking mechanisms on the roller drawer eliminate movement while closed. Retaining the drawer in this way stops rattle and wear and tear while driving.
- > **Purpose Folded Stainless Steel Runners** - The roller drawer bearings run on purpose folded stainless steel runners. Stainless steel offers the best surface for bearings to run on resulting in smooth quiet operation. Galvanized bearing runners are not used because the galvanized coating transfers onto the bearings creating rough operation and an opportunity for corrosion to start. Tool chest style



telescopic runners are not used because of the slop and movement they allow. This constant movement whilst driving accelerates wear and deterioration when used in automotive applications.

- > **UV Stable Commercial Carpet** - Exterior surfaces are finished in hard wearing commercial carpet and interior surfaces are trimmed in automotive boot carpet. Both materials resist abrasion and conceal dirt in tough off road conditions.
- > **Robust Finishes** - Aluminium trims are used to protect corners and ends of the drawer to improve longevity.
- > **Slam Shut Latches** - Slam shut/pull open handles make opening and closing the roller drawer an ease, even with hands full of gear. The roller drawer handle is key lockable.
- > **Drawer Dividers** - Fixed long divider to separate into 2 drawers + additional 2 removable dividers.
- > Fully galvanised steel chassis.
- > Lined with precision cut, quality boot carpet on the inner and outer side to give it a professional and neat finish.
- > Full fitting instructions included in packaging.

#### FKDEF

#### ARB Outback Solutions Modular Roller Drawer Side Floor Kit

The side floor kit is especially designed for fitment with the CRDDEF drawer module and fills in the area between the outer edge of the drawer and the side of the rear boot area. The side floor kit completes the floor and provides a larger flat top surface.

**Note** - Fridge slide not available for this drawer model.



**DA2977**



**DA2977**  
**Console Storage Box**  
 Defender - 2020

Make use of the space at the front of your centre console with this easy to fit plastic storage box. To stop items sliding around, the box features an easy to remove rubber mat.



**DA2603** Defender - 2007 onwards Black finish fascia plate  
**DA2603CF** Defender - 2007 onwards Carbon fibre effect finish fascia plate



**DA2603CF**

Neat storage solution for the Defender which utilises the available dashboard space. Ideal for storing all the usual small items you carry with you. Robust construction & easy to fit with all the necessary parts supplied. Suitable for right & left hand drive models.



**DA2610**  
**Coin Tray**  
 Defender - 1987 - 2006



### Interior Storage & Panels



DA4629



DA4629

**Roof Consoles**  
**DA4629** Grey  
**DA4629B** Black

This roof console fits all Defenders except sunroof equipped models. Supplied with interior light extension loom and DIN blanking panel. Fitting kit and instructions are also supplied. The console offers a unique storage solution for the Defender in providing additional overhead roof storage as well as a single DIN provision in one unit. The two side sections are designed to hold anything from maps to sunglasses, documents to magazines. The console is supplied in three separate pieces. The product has been designed with CAD software and the moulding finished off using CNC machinery to ensure an OE level fit and finish to the product. It is supplied with a DIN blanking panel but the central binnacle will fit any DIN sized accessory such as a stereo, CB/HAM radio or even a digital tachograph. The single DIN aperture will also accept a bank of seven Carling Technologies switches by using the Carling interlocking switch mounts.

**Will the Defender roof console fit my vehicle?**

The console has been designed to fit all post 1983 Defender models without a sunroof and with a factory headlining. The fixing method does not require removal or cutting of the headlining or sun visors. (Some later models will require trimming of the central area of the headlining when fitting a DIN unit). If you have a non-factory headlining it is unlikely it will fit without modification of the headlining. If you have a Series vehicle, again it is unlikely it will fit without modification.



DA2902

**DA2902**  
**Mesh Luggage Rack Shelf**  
 Defender 2020 - 110  
 65mm deep - front of rack  
 115mm deep - rear of rack  
 1,290 x 430mm  
 of usable rack  
 space

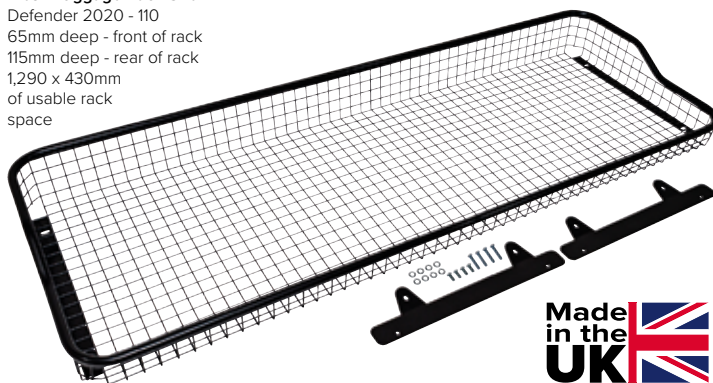

**DA4692**  
**Utility Wagon Trim Panels**

Protect the interior of your 110 Utility Wagon and improve upon the crude 'unfinished' factory look of the Land Rover 'window' trims with our MUD designed 110 Utility Wagon Trim Panels. The MUD 110 Utility Wagon Trim Panel fits behind the existing 'window' trim panel to create a smart factory look finish. The MUD 110 Utility Wagon Trim Panels are supplied in pairs with cargo nets that create useful extra storage within the cabin walls. Ideal for coats, shopping bags and pet paraphernalia! Each net features elasticised netting and is supplied with black headed flush fit fasteners for a professional appearance. With a typically MUD level of attention to detail, they've had the plastic of the MUD 110 Utility Wagon Trim Panel specially blended to match the correct 'Dark Granite' shade of the original trim panels to provide an OE appearance to the installation. Each MUD 110 Utility Wagon Trim Panel is supplied with four foam insulation panel that sit behind the trim panels to isolate vibrations and provides an additional layer of insulation.



DA2765



DA2764

**Interior Side Trim Panels**

**DA2764** Blank Black  
**DA2765** With nets Black

Defender 90

Designed to offer a smart factory appearance to the interior of any hardtop Defender 90. The rigid plastic trim offers added protection from accidental damage to your hardtop side panels, whilst the easy to clean surface means the rear loadspace remains dog-proof! The basic kit comes as a pair of moulded trim panels. The panels are a one piece moulding from ABS plastic. Each kit comes supplied with four self-adhesive foam backing pads and all the necessary fasteners and instructions. The kits are an easy DIY fit and can be installed with the minimum of tools in approximately 1.5 to 2 hours. Each kit is supplied with four closed cell foam pads to offer additional insulation and sound deadening to the interior of your Land Rover. The foam pads are supplied pre-cut and come fitted with self-adhesive backing for quick and easy installation.

**With Nets**

The recessed areas within the side panel trim has been designed to accept a 500 x 300mm wire frame storage net. Each net features elasticised netting and is supplied with black headed flush fit fasteners for a professional appearance.

**Note** - The kits will fit all Defender 90 hardtops fitted with side panels that have the vertical strengthening rib fitted. Early 90 models have a strengthening rib that runs horizontally across the side panel. Unfortunately the kits will not fit this variant.



DA2766

**Rear Quarter Trim Panels**

**DA2766** Blank Black  
**DA2767** With side window cut out Black

Defender 90

Rear quarter window panel trims to compliment interior side panel trims. The rear quarter window panel trims will finish off the side panel installation with a plastic trim surround to conceal the exposed bare metal to either side of the rear door opening. Available in two styles - with window cut out and without the window-cut-out to suit the later Defender 90 'Van' models when Land Rover stopped fitting the quarter windows as standard in van models. Fitting is a simple screw fixing. Fixings are supplied together with screw caps for a neat appearance. Some minor trimming of this product may be necessary (but not always) due to the variation in the fitment of the side-panels and factory hardtop.



DA2767

Steering Wheels



Momo Steering Wheels

DA5726	Quark style	Black/air leather	350mm
DA5727	Jet style	Black leather	350mm
DA5728	Millennium Sport style	Black/grey profile	350mm
DA5729	Nero style	Black/suede	350mm
DA5730	Tuner style	Black leather	350mm
DA5742	MOD.78	Black/suede	350mm
DA5737	Dark Fighter	Airleather/Alcantara	350mm

Momo Steering Wheel Bosses

DA5734	36 spline boss	
DA5735	48 spline boss	Defender - up to FA
DA5736	48 spline boss	Defender - FA onwards



Shown with bosses fitted

Moutney Steering Wheels

Steering wheels fit in conjunction with the Moutney boss kits.

**DA4650**  
15" 3-Spoke Sports Wheel  
Semi-dished wheel in black vinyl. Featuring a black anodised 3 spoke centre with holes.

**DA4654**  
14" 3-Spoke Sports Wheel  
Semi-dished wheel in black vinyl. Featuring a black anodised 3 spoke centre with holes.

**DA3920 NEW**  
15" Riveted Wood Rim  
This 'Traditional' steering wheel is a flat dish, riveted woodrim wheel. Featuring polished aluminium centre, polished aluminium 3 spokes with holes and polished aluminium centre ring.

**DA4876 NEW**  
15" Riveted Dark Wood  
This Classic steering wheel is a 15" semi dished, riveted dark woodrim wheel. Featuring a polished, 3 spoke centre with slots and a silver centre ring.

**DA4877 NEW**  
15" Riveted Wood Rim  
This Classic steering wheel is a 15" semi dished, riveted woodrim wheel. Featuring a polished, 3 spoke centre with slots and a silver centre ring

**Moutney Boss Kits**  
**DA4661** 16mm shaft/36 splines  
90/110 & Defender up to HA & 1A onwards  
This is drilled and has a contact plate. Pins are spaced at 38mm across, flat centre.  
**DA4659** 16mm shaft/36 splines  
90/110 & Defender up to HA & 1A onwards  
This is not drilled, pins are spaced at 28mm across, centre of splines casting is raised by 5mm.

**DA4660** 19mm shaft/48 splines  
Defender - JA onwards up to 2014  
Series 2/2A/3





# ENHANCEMENTS

## Defender

### Optimill Enhancements



#### Optimill Steering Wheel Bosses

**DA8880** Slimline boss 48 splines

**DA8881** Slimline boss 36 splines

Optimill slimline boss, measuring only 32mm in depth. Manufactured from a single anodized billet aluminium. Momo horn button will no longer fit due to this being so slim therefore an Optimill cap is supplied. Boss is supplied with screws and pins to cancel the indicators.

**DA8883** Slimline boss with quick release 48 splines

**DA8882** Slimline boss with quick release 36 spline

Optimill slimline boss fits directly to your steering column, without the need for multiple bosses to be used. Manufactured to the highest standard, hard anodised to prevent wear and designed to give an extra level of security to your vehicle. The slimline boss is just 42mm in depth, meaning it is only 10mm thicker than our original slimline boss. The boss is designed to fit Momo steering wheels or wheels with 6 holes on a 70mm PCD. Momo horn button will no longer be able to be used as the boss is so slim, therefore an Optimill cap is supplied along with screws and pins for installation. Note: This boss has 2 locking pins which are used to separate the boss. These must NEVER be pulled open whilst driving. This is designed as a removable product and it is the drivers responsibility to ensure it is fitted correctly and in full working order before attempting to drive the vehicle.

**Note** - Optimal steering bosses DA8880/1/2/3 don't fit Montney steering wheels DA4650 & DA4654.



## OPTIMILL

#### DA8884

##### Optimill Quick Release Security Lock

Produced as a swivel locking cover to fit over an Optimill Quick Release Boss (36 or 48 spline). Manufactured from billet aluminium. Outer body runs on a bearing to prevent the steering being turned. Anodized in bright orange for visibility. Supplied complete with lock & 2 keys.

#### DA8884DOCK

##### Optimill Quick Release Security Lock Docking Station

Manufactured to screw into your cubby box or where you choose to store your Optimill quick release swivel lock (not included) when not in use. Manufactured from billet aluminium and anodised silver.

#### DA8884DOCK



Photo by Mike Harris

Optimill Enhancements



**DA8860**  
**Billet Wing Mirror Arms with Puddle Light**  
 Defender - all models  
 Black. Supplied as a pair.

Manufactured from aerospace grade billet aluminium, anodised and assembled in house at Optimill. Comes pre-wired for heated mirror heads and fitted puddle lights. Manufactured to fit both Optimill and original door hinges. The hinges may require drilling to hide the wires into the door. (Optimill hinges now come pre-drilled to accompany this modification). All fixings and drilling templates are supplied for ease of fitting. These mirror arms are 20mm longer to aid towing trailers/caravans.



**DA8861**  
**Billet Wing Mirror Arms**  
 Defender - all models  
 Black. Supplied as a pair.  
 Manufactured from aerospace grade billet aluminium, anodised and assembled in house at Optimill. Designed to fit both original and Optimill door hinges. All fixings and drilling templates are supplied for ease of fitting. These arms are 20mm longer to aid towing trailers/caravans.



**DA8862**  
**Number Plate Light with Camera**  
 Defender - all models  
 Black  
 Complete with HD 170 degree camera & LED number plate light. Billet machined from 6082 aluminium. Plug & Play to plug into factory Land Rover wiring loom. Fitted using the existing holes in the body. Supplied with foam gasket and stainless steel screws.



**DA8863**  
**Defender Number Plate Light**  
 Defender - all models  
 Black  
 Billet machined from 6082 aluminium. Complete with LED number plate light. Plug & Play to plug into factory Land Rover wiring loom. Fitted using the existing holes in the body. Supplied with foam gasket and stainless steel screws.



**DA8867**  
**Security Bonnet Hinge Kit**  
 Defender - all models  
 Black. Supplied as a pair.  
 These are CNC machined billets of aluminium 6082-T6. Internally pinned to prevent unwanted removal of the bonnet. Anodised for extra protection and longevity. The set comprises of high security stainless steel fixings which are fixed from underneath the bonnet for added security.



**DA8862MONITOR**  
**Rear View Mirror Camera Monitor**  
 Practical high quality 4.3-inch TFT-LCD auto rear-view mirror monitor, which is suitable for car reverse cameras, DVD, VCD player, and supports 2-way video inputs. Works perfectly with the Optimill number plate light with reversing camera. The monitor will start up automatically, and synchronously display the video from the rear view camera when you're backing your Defender. It is easy to install without damaging to any parts of your vehicle - clip the monitor on the original one.

**DA8866**  
**Rear Door Security Hinge Kit**  
 Defender - all models  
 Black  
 Designed with concealed fixings, to prevent access from outside the vehicle. CNC machined from billets of aerospace grade 6082-T6 aluminium. The hinge pins are made of stainless steel which are internally pinned to prevent unwanted removal. The hinges also feature self lubricating graphite bushes to reduce friction and prevent wear. The superior performance of these hinges means there is no longer a need to use a separate swing away type wheel carrier, although are compatible with most makes, they are also compatible with panoramic glass conversions. Supplied with high security stainless fixings.



**DA8862LOOM**  
**Wiring Loom For Number Plate Light With Reversing Camera**  
 Small piggy back wiring loom that fits between original plug and reversing light, enabling fitment of the new number plate light and provide the live power feed for the reversing camera.

**Note**  
 Optimill recommend that no TFR (Traffic Film Remover) solutions found in some cleaning products, should be used on their anodised products.



**DA8864**  
**Front Door Security Hinge Kit**  
 Defender 90 - all models  
 Black  
 With this unique design the door cannot be removed even if the external screws have been removed. Prevention increases security for unwanted removal. These high quality door hinges are CNC machined from billets of aerospace grade 6082-T6 aluminium. The hinge pins are made of stainless steel which are internally pinned to prevent unwanted removal or theft. The hinges also feature self lubricating graphite bushes to reduce friction and prevent wear. Supplied with high security stainless fixings & shims.



**DA8865**  
**Front Door Security Hinge Kit**  
 Defender 110 - all models - 1st & 2nd row doors  
 Black



Britpart



# ENHANCEMENTS

## Defender

### Dynamat Sound Deadening



#### Dynamat Xtreme Sound Deadening

Dynamat Xtreme is the highest efficiency sound deadening material available and the most effective product for stopping noise and vibration. Xtreme can be used on any and all interior sheet metal and fibreglass body panels. The aluminium constraining layer is very moldable and conforms easily to all interior surfaces. The patented extra sticky butyl layer is formulated with VECTOR chemistry for the most amazing energy conversion capabilities ever. Use it on your doors, floor, roof, bonnet and loadspace for a quiet, cool and incredibly solid ride.

- > Create a solid, luxury car feel with a reduction in road noise
- > Stop resonance & vibrations, reduces buzzes & rattles
- > Improved sound. Get more bass. Hear more of your music
- > For use throughout your vehicle interior, the first step to a great car



DA8091	Defender - 1983 - 1998	Bonnet
DA8093	Defender - Td5	Bonnet
DA8092	Defender - 2007 onwards	Bonnet
DA8094	Defender - 1983 - 2006	Foot wells
DA8083	Defender - 2007 onwards	Foot wells
DA8095	Defender - 1983 - 2006	Seat box
DA8084	Defender - 2007 onwards	Seat box
DA8085	Defender - 2007 onwards	Rear tub behind front seats
DA8086	Defender - 90 - 1983 - 2006	Rear tub floor
	Defender - 90 - 2007 onwards	
DA8087	Defender - 90 - 1983 - 2006	Rear wheel arches
	Defender - 90 - 2007 onwards - commercial only	
	Defender - 110 - 1983 - 2006 - Station Wagon	
DA8096	Defender - 90 - 2007 onwards - County	Rear arches
DA8150	Defender - 90 - 2000 - 2006 - County <b>NEW</b>	Rear arches
DA8088	Defender - 110 - 2007 onwards - Station Wagon/Utility	Rear arches
DA8097	Defender - 90 - 2007 onwards - County	Rear floor
DA8089	Defender - 110 - 2007 onwards - Station Wagon/Utility	Rear floor
DA8090	Defender - 110 - 2007 onwards - Station Wagon/Utility	2nd row floor/under seats
DA8076	Dynamat Xtreme sheet	1,200 x 610mm x 1 sheet
DA8076X	Dynamat Xtreme mega pack <b>NEW</b>	1,200 x 610mm x 9 sheets

#### DA8098

##### Dynamat Heavy-duty Roller Tool

To ensure proper adhesion with the strongest bond possible and with professional looking results.

- > Thick, plated steel frame
- > Water and rust resistant
- > 2" solid rubber roller
- > Comfort grip handle
- > Soft rubber will not scratch surface

#### DA8102

##### DynaTape

38mm wide x 9.1 meters long  
DynaTape is a 1½" wide, 2 mil aluminium finishing tape. DynaTape can be used with Dynamat to seal seams, fill holes, attach wiring, contain unwanted butyl migration and give your project a complete and professional appearance. DynaTape's transparent, pressure sensitive acrylic, peel and stick adhesive makes finishing your project a simple process, providing you with a cool, quiet and comfortable ride.

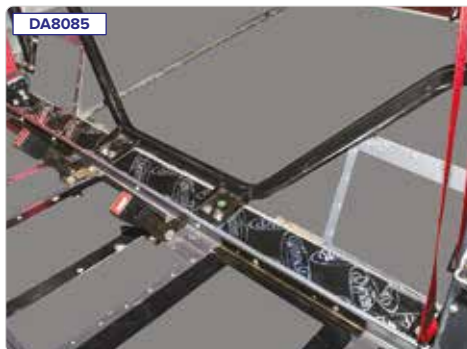

All kit images available at  
[www.britpart.com/dynamat](http://www.britpart.com/dynamat)

*The highest efficiency sound deadening material available*

*Use it for a quiet, cool and incredibly solid ride*





Transmission

**Red Booster Servo Clutch Kit**

The Red Booster servo clutch kit makes your Defenders clutch much easier to press. This kit will make your driving a more pleasurable experience and reduce the effort you'd normally put in from driving your Defender. No more painful knees or feet when you are stuck in slow moving traffic!

Designed, engineered and manufactured to the highest standards, Red Booster is a mechanism system that makes it possible for all Defenders to have a servo assisted clutch. Working in a similar way to the braking system with a servo assisted system, it is mounted between the pedal and master cylinder and uses a vacuum from the inlet manifold to reduce the amount of pressure needed on the pedal to operate the clutch.

The left hand drive version - works similar to the right hand drive system. The location of the clutch pedal of a left hand drive Defender is on the far corner of the vehicle and with hardly any space the entire unit had to be redesigned to fit without cutting and drilling your vehicle.

<b>DA1683</b>	Defender - 2007 onwards	Right hand drive
<b>DA1684</b>	Defender - Td5	Right hand drive
<b>DA1685</b>	Defender - 300Tdi	Right hand drive
<b>DA1686</b>	Defender - 200Tdi	Right hand drive
<b>DA1955</b>	Defender - 200Tdi & 300Tdi	Left hand drive
<b>DA1687</b>	Defender - 2007 onwards	Left hand drive
<b>DA1688</b>	Defender - Td5	Left hand drive

*"The next best thing to having an automatic when crawling along"*

John Pearson - LRO editor-in-chief



See how easy it is to operate a clutch with a Red Booster fitted at [www.britpart.com/red](http://www.britpart.com/red)



**DA1266 Clutch Pedal Assist Kit**

Replace the old clutch pedal spring kit to assist the pressing of the clutch pedal on Defender models. This is a factory fit on later models but can be retro fitted to all 90/110 models. Consists of spring, spring retainer & spring bushes.

DA1683

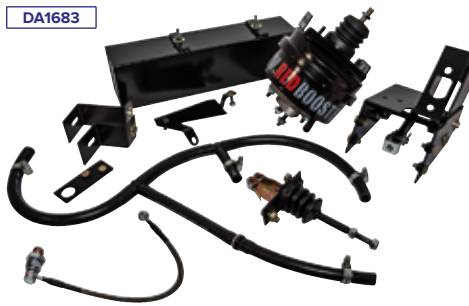

DA1685



**RED BOOSTER**

DA1688



Photo by Annabel Sammut



### Engine Bay Enhancements



**Filler Plugs**  
ERR4686BLUE  
ERR4686RED

Replace your existing filler plug with one of these smart anodised aluminium ones. Suitable for use on a Defender, Discovery 1 & Range Rover Classic on the radiator and thermostat housing. Can also be used on the diff filler level on a Discovery 2.

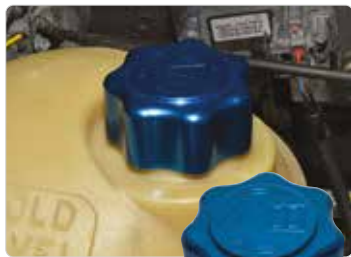

**DA8896**  
**Expansion Bottle Cap**

Defender - Td5 onwards  
Freelander 1  
Smart anodised aluminium direct replacement expansion bottle cap - PCD100160. Will not fit on aluminium header tank - DA4751.



**DA8891**  
**Oil Filler Cap**

Defender - Tdci  
Anodised aluminium. Includes rubber seal

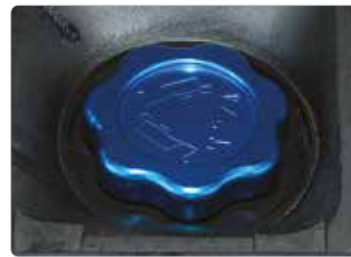

**DA8890**

**Oil Filler Cap**  
Defender - Td5  
Anodised aluminium. Includes rubber seal



**Top Hose Bleed Screws**  
PYP10008BLUE  
PYP10008RED

Smart replacement anodised aluminium bleed screws for the top hose on a Td5 engine.



**Coolant Overflow Container Bleed Screws**  
LR055301BLUE  
LR055301RED

Most Land Rovers post 2010. Discovery 4/  
Range Rover Sport - Mk1/Range Rover L322/  
Range Rover L405  
Check screw top diameter - 21mm

**DA4748**

**Upgraded Engine Breather Oil Catch Tank**

200Tdi & 300Tdi engines  
Allisport high performance aluminium engine breather oil catch tank separator. Manufactured using mounting flange machined from billet aluminium. All engines need to breathe crankcase pressure to atmosphere and most are designed to re-enter the air intake system after the air cleaner.

Standard breather pots use a gauze and mesh design which over time becomes blocked with oil deposits, reducing the capacity to release crankcase pressure and also allowing more oil vapour to enter the intake system. This high performance replacement is designed to effectively reduce crankcase pressure build up on Tdi engines by using an internal baffle rather than the standard gauze and mesh design. Designed to have a practical purpose offering an improvement over the original black plastic units, but will also look great in the engine bay. Will fit all Tdi engines including 2.8 TGV. Manufactured by hand, fully TIG welded. Tank has new integral O ring-seal design - **No More Leaks!!**



**DA4749 NEW**  
**Aluminium Power Steering Reservoir with Internal Baffle**

Defender - Tdi, Td5, Tdci & V8  
Designed to replace the plastic ZF reservoir which is prone to splitting and leaking vapour through the breathable cap, which in turn then collects dirt and runs the risk of water ingress. The external breather design means no unsightly mess under the bonnet and allows routing with high axle/gearbox breathers to eliminate water ingress. Manufactured from laser cut 2mm high grade aluminium with CNC machined pipe connections, knurled cap and external breather. The corrosion resistant aluminium rolled body is fully TIG welded by hand in house. 110mm high (155mm height including cap) & 91mm diameter.



**Power Steering Reservoir Cap**

**DA8895** Standard  
**DA8894** With cooling fins for extreme off-road and racing conditions

Defender  
Anodised aluminium. Includes rubber seal.

**DA8894**

**DA8895**



**DA4751**

**Aluminium Header Tanks**  
**DA4750**

Defender - 200Tdi/300Tdi/V8  
Discovery 1 - 200Tdi/300Tdi/V8  
Range Rover Classic - petrol & diesel - 1990 onwards

**DA4751** Defender - Td5 & Td4 Tdci  
These are direct replacements for the original plastic tanks which are prone to splitting. TIG welded by hand and manufactured from high specification lightweight non-corrosive alloy, these tanks also aid cooling. Tanks use original pressure release screw cap and are a straight fit with no modifications required. Ideal for motorsport, overland or just to improve the look of your engine bay.

*Direct replacements for the original plastic tanks*



Photo by Hossein Farahani

**Stainless Steel Screw & Bolt Kits**



**DA1133** Front & Rear Door - 4-door - Bolt Kit  
 DA1133P Defender - 2007 onwards



**DA1132** Front Door - 2-door - Bolt Kit  
 DA1132P Defender - 2007 onwards



**DA1260** 2nd Row Door - Bolt Kit  
 DA1260P Defender - 2007 onwards



**DA1145** Rear Door - Hinge Pin Kit  
 Defender/Series



**DA1134** Rear Door - Safari - Bolt Kit  
 DA1134P Defender - 2007 onwards



**DA1135** Bonnet Hinge - Bolt Kit  
 Defender



**DA1139** Bumper - Bolt Kit  
 Defender



**DA1136** Rear Cross Member to Body - Bolt Kit  
 Defender



**DA4000-1FK** Bonnet Vent - Screw Kit  
 Defender



**DA1169** Headlight Panel - Screw Kit  
 Defender



**DA1138** Front Grille Kit - Screw Kit  
 Defender



**DA1977** Air Intake Grille - Screw Kit  
 Defender



**DA1137** Light Lens - Screw Kit - Sidelights, Indicators & Rear Lights  
 DA11168 Defender - up to MA94004  
 DA11168 Defender - MA94005 onwards



**DA8200** Anti-luce Pin Kit



**DA4795** Rear Crossmember Fixing Kit  
 Defender/Series 2 & 3  
 To bolt rear tub to rear body mounting to chassis.

Using these smart stainless steel replacement bolt and screw kits will prevent rust from spoiling your Defender's bodywork - ideal for smartening up your vehicle or a restoration job. For more information on the kits contents please look online at [www.britpart.com/bolts](http://www.britpart.com/bolts)

*Prevent rust from spoiling your Defender's bodywork!*



**Series**



**XFC100550CH** Number Plate Light  
 Chrome



**DA6110** Headlight Surround  
 Series 1, Series 2 & Series 2A  
 Chrome



*The Possibilities*  
Are **Endless...**

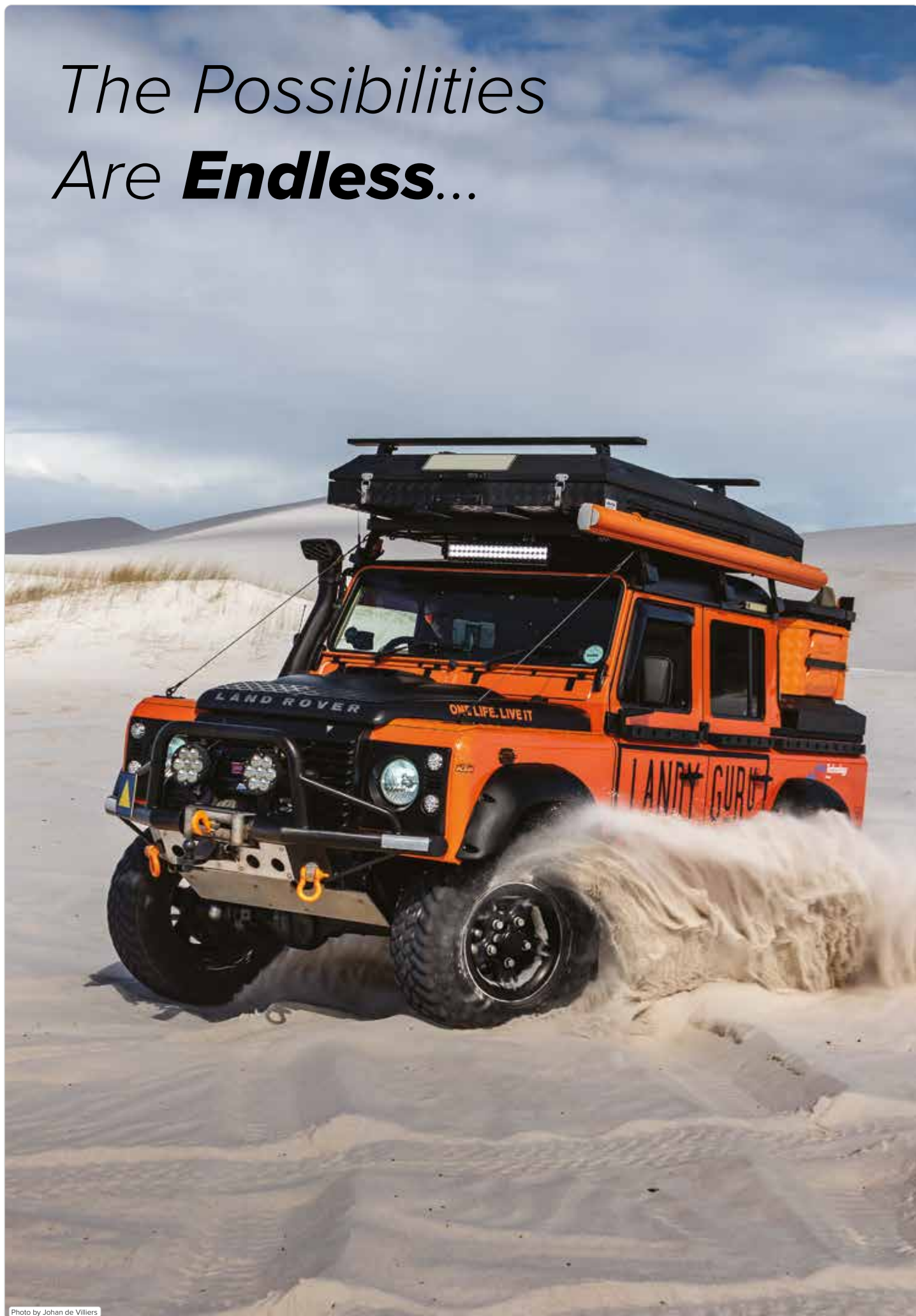

Photo by Johan de Villiers



**DA1071**  
Rear Stainless Steel Bumper Cover



**DA1072**  
Oval Rear Badge Surround  
Metal - chrome finish



**DA1073**  
Front & Rear Lower Sill Step Covers  
Brushed finish - pair



**VUB503650**  
Air Intake Grille  
Plastic - chrome finish - pair



**DA5655**  
Fog Light Bezels  
2006 - 2009 (from 6A000001)  
Plastic - chrome finish - pair



**Door Handle Enhancements**  
**DA5653** Door handle cover - up to 2010  
Plastic - chrome finish Set of 4  
**DA5654** Door handle surround  
Plastic - chrome finish Set of 4



**Wing Mirror Covers**  
**VUB503880MMM** Wing mirror covers - top  
5A - 9A999999 (adhesive STC50551) Pair  
Plastic - chrome finish  
**LR003905** Wing mirror covers - bottom  
5A - 9A999999 (adhesive STC50551) Pair  
Plastic - chrome finish



**VUB001070LR**  
Front Light Guards  
Up to 2006 Black Pair  
Not compatible with wraparound protection bar



**Side Steps**  
**VUB503660** Including front mudflaps Pair  
EPDM (synthetic rubber) top and hard plastic trimming  
Side step replacement insert moulding for VUB503660  
**VUB001300** Right hand side Single  
**VUB001310** Left hand side Single



**VUB001230**  
Side Protection Tubes  
Stainless steel Pair  
Tubes can be fitted with or without front mudflaps.



**DA5556**  
Premium Loadspace Mat  
Range Rover L322  
2" deep sides

**Double DIN Radio Install Fascia, Steering Wheel Control Interface & Antenna Adapter**

**DA2604** Range Rover L322 - excludes amplified  
**DA2616** Range Rover L322 - amplified

- > Allows you to upgrade to an aftermarket head unit whilst maintaining use of your factory steering wheel controls
- > Plug and play, no cutting of wires required. Contains universal patchlead
- > Maintains the original features of the vehicle such as date, time and temperature display
- > Choose the relevant head unit connection lead according to the make of aftermarket head unit you wish to fit



**DA2604**



# ENHANCEMENTS

## Range Rover L405



**DA4822**  
**Premium Loadspace Mat**  
Semi-rigid foam with anti-slip finish & 2" deep sides



**VPLGS0153LR**  
**Umbrella Holder**  
Excludes umbrella  
Pair



**VPLGP0226**  
**Side Steps**  
Pair

### Powered Side Steps

**VPLGP0367LR**

Powered side step - step      Left hand

**VPLGP0248LR**

Powered side step - fixings      Left hand

**VPLGP0366LR**

Powered side step - step      Right hand

**VPLGP0249LR**

Powered side step - fixings      Right hand



Photo by Sahil Singh



**DA1072**  
Oval Rear Badge Surround  
Metal - chrome finish



**DA5660**  
Fog Light Surrounds  
2005 - 2009 Plastic - chrome finish - pair



**Air Intake Grilles**  
**DA3351** Plastic - chrome finish Right hand side Single  
**DA3352** Right & left hand side Pair



**DA5667**  
Air Intake Grille Kit  
Chrome finish - pair  
2010 Autobiography style for 2002 - 2009 models



**DA5668**  
Air Intake Grille Kit  
Silver finish - pair  
2010 Autobiography style for 2002 - 2009 models



**Door Handle Enhancements**  
**DA5658** Door handle cover Plastic - chrome finish Set of 4  
**DA5659** Door handle bowl Plastic - chrome finish Set of 4



**Indicator Lights**  
**LR007954** Clear with orange bulb Single  
**DA7611** Smoked with orange bulb Single  
**XGB000073LEDSM** Smoked with LED lights Single



**Headlight Washer Jet Caps**  
**DA5661** Chrome Pair  
**VPLAB0025LMLLR** Primed Pair



**Wing Mirror Covers** Plastic - chrome finish Pair  
**VUB503880MMM** Wing mirror covers - top (adhesive STC50551)  
**LR003905** Wing mirror covers - bottom (adhesive STC50551)



**DA6290**  
Tailgate Conversion Trim Kit  
Range Rover Sport - 2005 - 2011  
The rear tailgate on the Range Rover Sport changed in 2012 from a two piece tailgate (with opening top window section) to a one piece tailgate & above the registration plate a new silver strip was added that went the width of the tailgate. If you have a 2005 - 2011 model and want to make it look like the 2012 model from the rear you can fit this clever conversion kit. The kit consists of 3 panels - 1. Underside base - section made from ABS plastic in grey primer finish - you will need to paint this part black. 2. Top section - supplied in primed ABS plastic ready for painting body colour 3. Strip section - chrome plated plastic. This is a bolt on replacement kit that replaces the existing panels on the upper tailgate. Easy to fit. More details online.

**Enhance** the look of  
your Range Rover Sport



# ENHANCEMENTS

## Range Rover Sport - Mk1



**VPLSS0042**  
**Side Sill Tread Plate**  
 Stainless steel  
 Set of 8



**LR008713**  
**Pedal Set**  
 Stainless steel & rubber  
 Set of 3



**VPLSP0040**  
**Side Steps**  
 Side steps with thermo plastic elastomer side step top and brushed aluminium side trim. Pair.



**DA2611**  
**Double DIN Radio Install Fascia**  
 Range Rover Sport - 2005 - 2013  
 Non-amplified vehicles only

**DA2652**  
 Range Rover Sport - 2005 - 2013  
 Fibre optic amplified vehicles only

Double DIN radio install fascia, steering wheel control interface and antenna adapter

- > Allows you to upgrade to an aftermarket head unit whilst maintaining use of your factory steering wheel controls
- > Plug and play, no cutting of wires required
- > Maintains the original features of the vehicle such as date, time and temperature display
- > Choose the relevant head unit connection lead according to the make of aftermarket head unit you wish to fit
- > Contains universal patchlead



**DA1390**  
**Fuel Burning Heater**  
 Range Rover Sport - 2.7 & 3.6  
 Range Rover Sport - 3.0 - when timed climate is activated  
 Fuel burning heater is ideal for warming your engine on cold winter mornings while sat in the comfort of your house, no need to go outside and start your engine to defrost the car. The heater is triggered using one of two main options. The first is your Land Rover original blip using its 3rd button, secondly by sending an SMS. As well as a FBH this controller can do a host of other functions including - clear faults, fuel pump prime, diagnostic and statuses on SMS, various run modes, SMS controlled GPS tracking and so much more.  
 For much more information - [www.britpart.com/DA1390](http://www.britpart.com/DA1390)



**VUB501980**  
**A Bar**  
 2005 - 2009  
 Grey moulded plastic  
 Includes spot light brackets



**DA5555**  
**Premium Loadspace Mat**  
 Range Rover Sport - 2005 - 2013  
 2" deep sides



Photo by Ray Cully





**DA5662**  
**Fog Light Surrounds**  
 Discovery 3  
 Plastic - chrome finish      Pair



**DA5664**  
**Fog Light Surrounds**  
 Discovery 4  
 Plastic - chrome finish      Pair



**Headlight Washer Jet Caps**  
**DA5661**      Chrome      Pair  
**VPLAB0025LMLLR**      Primed      Pair



**DA5689**  
**Side Vent Trim**  
 Discovery 3  
 Discovery 4 style      Plastic - black gloss finish      Single



**DA5669**  
**Side Vent Trim**  
 Discovery 3  
 Discovery 4 style      Plastic - chrome finish      Single



**DA5670**  
**Side Vent Trim**  
 Discovery 3  
 Discovery 4 style      Plastic - silver finish      Single



**JAK000065MMM**  
**Side Vent Trim**  
 Discovery 3      Plastic - stainless steel finish      Single



**Wing Mirror Covers**      Plastic - chrome finish      Pair  
**VUB503880MMM**      Wing mirror covers - top  
 Discovery 3      (adhesive STC50551)  
**LR003905**      Wing mirror covers - bottom  
 Discovery 3      (adhesive STC50551)



**Indicator Lights**  
 Discovery 3  
**LR007954**      Clear with orange bulb      Single  
**DA7611**      Smoked with orange bulb      Single  
**XGB000073LEDSM**      Smoked with LED lights      Single

**Enhance** the look of your Discovery 3 or 4



**EBN500041**  
**Side Sill Tread Plate Kit**  
 Discovery 3/Discovery 4  
 Stainless steel - set of 4



**LR008713**  
**Pedal Set**  
 Discovery 3  
 Stainless steel & rubber - set of 3





# ENHANCEMENTS

## Discovery 3 & Discovery 4



**VUB501200**  
**Front Light Guards**  
 Discovery 3  
 Black  
 Pair



**VUB501380**  
**Rear Light Guards**  
 Discovery 3  
 Black  
 Pair



**VTD500010**  
**Side Protection Tubes**  
 Discovery 3/Discovery 4  
 Black steel  
 Pair



**VTD500020**  
**Side Protection Tubes**  
 Discovery 3/Discovery 4  
 Stainless steel  
 Pair



**VPLAP0035**  
**Side Steps**  
 Discovery 3/Discovery 4  
 Polypropylene side step top & brushed aluminium side  
 Pair



**DA5602**  
**Premium Loadspace Mat**  
 Discovery 3/Discovery 4  
 3" deep sides



**DA1512**  
**Electric Deployable Side Steps**  
 Discovery 4

- > Easy access to your Discovery 4
- > Never available from Land Rover as an OE option
- > Smart design. Enhance the look of your Discovery 4
- > Tucked away when driving, prevents damage. Fixed steps susceptible to damage when driving off-road



See them in action at  
[www.britpart.com/DA1512](http://www.britpart.com/DA1512)

- > Side steps automatically lower into place when a door is open and raise once door is shut
- > Safety cut-off should step encounter an object
- > Function to lower step with door shut - ideal for accessing the roof
- > Manufactured from aluminium - strong and light







**DA2666**  
**Double DIN Radio Install Fascia**  
 Discovery 4

Complete a full aftermarket head unit installation from start to finish with this installation kit, containing everything you need for a perfect upgrade in one box.

**Note** - Only compatible with stereos that have a front face dimension of 178 x 96mm.

- > Allows for the installation of a double DIN aftermarket stereo
- > Allows for relocation and retention of OEM clock
- > Includes mounting brackets and fitting accessories
- > Retains steering wheel control functionality
- > Retains OEM MOST amplified system
- > Retains phone button functionality
- > Provides outputs for speed pulse, park brake and reverse gear
- > Updateable via USB
- > Comes with universal patch lead for the plug and play connection of the kit to any brand of aftermarket head unit



**DA1390**  
**Fuel Burning Heater**

Discovery 3 - 2.7

Discovery 4 - 3.0 - when timed climate is activated

Fuel burning heater is ideal for warming your engine on cold winter mornings while sat in the comfort of your house, no need to go outside and start your engine to defrost the car. The heater is triggered using one of two main options. The first is your Land Rover original blip using its 3rd button, secondly by sending an SMS. As well as a FBH this controller can do a host of other functions including - clear faults, fuel pump prime, diagnostic and statuses on SMS, various run modes, SMS controlled GPS tracking and so much more.

For much more information - [www.britpart.com/DA1390](http://www.britpart.com/DA1390)



**Double DIN Radio Install Fascia**

**DA2611**  
 Discovery 3 Non-amplified vehicles only

**DA2652**  
 Discovery 3 Fibre optic amplified vehicles only

Double DIN radio install fascia, steering wheel control interface and antenna adapter

- > Allows you to upgrade to an aftermarket head unit whilst maintaining use of your factory steering wheel controls
- > Plug and play, no cutting of wires required
- > Maintains the original features of the vehicle such as date, time and temperature display
- > Choose the relevant head unit connection lead according to the make of aftermarket head unit you wish to fit
- > Contains universal patchlead



Blanking Plug  
 DA8893

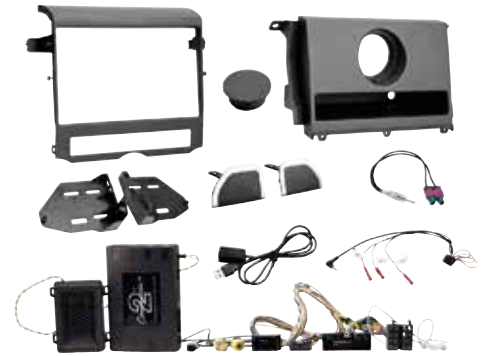

**DA1921**  
**Double DIN Radio Install Fascia**  
 Discovery 4

Retains visual parking display  
 Upgrade your Discovery 4 head unit and retain the OEM look, feel and functionality of your vehicle. Allows for the complete installation of a double DIN stereo whilst retaining all key factory features. For vehicles with basic display. Retains steering wheel controls, USB input, vehicle warning/park assist functionality and settings menus.

Allows for relocation of OEM clock and button panel. Behind the dashboard the plug-and-play interface will retain the vehicle's steering wheel control functionality, phone buttons and visual parking aid functionality whilst also providing CAN-Bus outputs for parking brake trigger, speed pulse, reverse gear and mute.

To complete the installation, the bespoke fascia panel sits seamlessly in the OEM dashboard, surrounding the stereo and allowing for the retention of the OEM clock. The fascia panel is painted to match the meteor grey components with accents of satin silver to preserve the aesthetics of the dashboard.





# ENHANCEMENTS

## Discovery 3 & Discovery 4



**DA1474**  
Front Safety Belt Frame Trim  
Discovery 4  
Pair



**DA1493**  
Front Safety Belt Cover Trim  
Discovery 4  
Pair



**DA1473**  
Rear Seat Belt Cover Trim  
Discovery 4  
Pair

*Enhance the interior of your Discovery 4 with these smart trim kits which complement the original trim. These trim kits have been made to fit over the existing trim and have a silver satin chrome finish. Manufactured from ABS plastic with self-adhesive tape for a really easy fit.*



**DA1490**  
Window Lift Switch Button Trim  
Discovery 4  
Front & rear  
Set of 3



**DA1515**  
Window Lift Trim  
Discovery 4  
Front & rear  
Set of 4



**DA1488**  
Rear Reading Light Trim  
Discovery 4  
Single



**DA1481**  
Interior Dash Vent Trim  
Discovery 4  
Pair



**DA1480**  
Rear Air Outlet Vent Ring Trim  
Discovery 4  
Pair



**DA1482**  
Microphone Cover Trim  
Discovery 4  
Single

## Discovery Sport

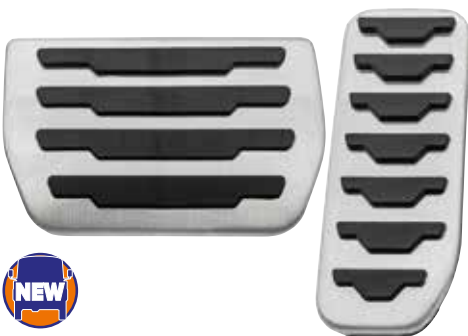

**DA2974 NEW**  
**Aluminium Pedal Kits**  
Discovery Sport  
Enhance your Land Rover's interior with these smart looking brake and accelerator pedals. Featuring a rubber anti-slip design, they are easy to fit. Simply remove the existing pad and replace with these. Suitable for both right and left hand drive vehicles.



**DA4829**  
**Premium Loadspace Mat**  
Discovery Sport  
2" deep sides



Photo by Zoltan Tasi



**Front Audio Speaker Ring Trim**  
Discovery Sport  
**DA1544** Silver Pair  
**DA1566** Black Pair



**Dashboard GPS Screen Frame Trim**  
Discovery Sport  
**DA1540** Silver Single  
**DA1554** Black Single

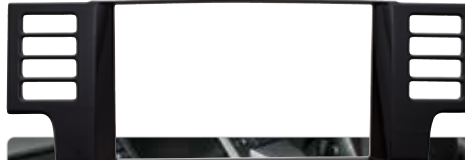

**DA1560**  
**Centre Console Button Trim**  
Discovery Sport  
Black  
Pair



**DA1533**  
**Gear Shift Panel Frame Trim**  
Discovery Sport Silver Single



**DA1534**  
**Central Console Trim**  
Discovery Sport Silver Pair



**DA1552**  
**Front Seat Belt Cover Trim**  
Discovery Sport Silver Pair



**DA1543**  
**Child Lock Frame Trim**  
Discovery Sport Silver Set of 4



**DA1557**  
**Front Seat Side Frame Trim**  
Discovery Sport Black Pair



**DA1563**  
**B-Pillar Air Conditioning Trim**  
Discovery Sport Black Pair

*Enhance the interior of your Discovery Sport with these smart trim kits which complement the original trim.*

*These trim kits have been made to fit over the existing trim and have a silver satin chrome or black gloss finish.*

*Manufactured from ABS plastic with self-adhesive tape for a really easy fit.*

**DA3389 NEW**  
**Smoked Dynamic LED Indicators**  
Discovery Sport  
Plug & Play, easy install with super bright LEDs  
CE & E-mark certificate  
Equivalent to LR048351 & LR048352

**DA3389**



**DA1550**  
**Rear View Mirror Trim**  
Discovery Sport Silver Single



**DA1564**  
**Rear Reading Light Frame Trim**  
Discovery Sport Black Pair



**DA1556**  
**Door Bowl Trim**  
Discovery Sport Black Set of 4



# ENHANCEMENTS

## Range Rover Evoque



**Bonnet Grille**  
**LR026593LR** Up to 2019 only - 3-door  
 Right hand side  
**LR026596LR** Left hand side



**Bonnet Grille**  
**LR026592LR** Up to 2019 only - 3-door  
 Right hand side  
**LR026595LR** Left hand side



**Bonnet Grille**  
**LR032305LR** Up to 2019 only - 3-door  
 Right hand side  
**LR032306LR** Left hand side



**VPLVP0184**  
**Side Protection Tubes**  
 Up to 2019 only Stainless steel



**DA8893**  
**Blanking Plug**  
 Pair

**Enhance** the  
 look of your  
 Range Rover Evoque

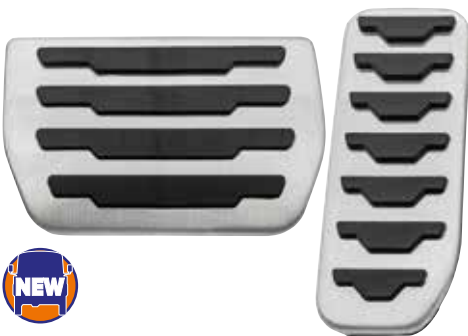

**DA2974 NEW**  
**Aluminium Pedal Kits**  
 Range Rover Evoque - 2012 - 2018 & 2019 onwards  
 Enhance your Land Rover's interior with these smart looking brake and accelerator pedals. Featuring a rubber anti-slip design, they are easy to fit. Simply remove the existing pad and replace with these. Suitable for both right and left hand drive vehicles.



**DA3389 NEW**  
**Smoked Dynamic LED Indicators**  
 Range Rover Evoque - from EH000001 onwards  
 Plug & Play, easy install with super bright LEDs  
 CE & E-mark certificate  
 Equivalent to LR048351 & LR048352



**DA5557**  
**Premium Loadspace Mat**  
 Range Rover Evoque  
 Semi-rigid with 2" deep sides



## Freelander 1

**DA2613**  
**Double DIN Radio Install Fascia**  
 Freelander 1 - 2004 - 2006  
 Double DIN radio install fascia, steering wheel control interface and antenna adapter  
 > Allows you to upgrade to an aftermarket head unit whilst maintaining use of your factory steering wheel controls  
 > Plug and play, no cutting of wires required  
 > Maintains the original features of the vehicle such as date, time and temperature display  
 > Choose the relevant head unit connection lead according to the make of aftermarket head unit you wish to fit  
 > Contains universal patchlead



**DA8535 NEW**  
**LED Smoked LED Indicators**  
 Freelander 1



**DA5663**  
**Fog Light Surrounds**  
 Pre-facelift models only Plastic - chrome finish Pair



**LR002773**  
**LR002773**  
**Side Steps**  
 Pair  
 Thermo plastic elastomer side step top and a brushed aluminium side trim



**LR004088**  
**Fog Light Upgrade Kit**  
 Freelander 2 - up to AH999999  
 Upgrade your Freelander 2 with this genuine driving and fog light upgrade kit. Adds driving lights to Freelander 2 models with fog lights, giving you better all-round night vision. The kit comes with everything you need to upgrade to driving lights (vehicle must have bumper fog lights already fitted).



**DA5554**  
**Premium Loadspace Mat**  
 Freelander 2  
 2" deep sides



**Indicator Lights**  
**LR007954** Clear with orange bulb Single  
**DA7611** Smoked with orange bulb Single  
**XGB000073LEDSM** Smoked with LED lights Single



**Wing Mirror Covers** Plastic - chrome finish Pair  
**VUB503880MMM** Wing mirror covers - top (adhesive STC50551)  
**LR003905** Wing mirror covers - bottom (adhesive STC50551)



**LR002525**  
**Front & Rear Sill Tread Plate Kit**  
 Polished stainless steel - set of 4



**Double DIN Radio Install Fascia**  
**DA2611** Freelander 2 Non-amplified vehicles only  
**DA2652** Freelander 2 Fibre optic amplified vehicles only

Double DIN radio install fascia, steering wheel control interface and antenna adapter

- > Allows you to upgrade to an aftermarket head unit whilst maintaining use of your factory steering wheel controls
- > Plug and play, no cutting of wires required
- > Maintains the original features of the vehicle such as date, time and temperature display
- > Choose the relevant head unit connection lead according to the make of aftermarket head unit you wish to fit
- > Contains universal patchlead



**DA2872**  
**CAN-Bus Steering Wheel Control Interface**  
 Freelander 2 - Non Amplified Vehicles  
 CAN-Bus steering wheel control interface. This product retains the vehicle steering wheel controls and factory phone buttons (if vehicle is equipped) when installing a new head unit. In addition, this interface retains the parking sensors audio tones where they are generated outside of the audio system. This product is for non amplified vehicles. Allows you to upgrade to an aftermarket head unit whilst maintaining use of your factory steering wheel controls. Plug and play, no cutting of wires required. Safety: Allows you to keep your hands on the steering wheel and eyes on the road.



**DA3292**  
**Rear Spoiler**  
 Easy to fit - no drilling Primed (as shown)

**Enhance** the look of your Freelander 2



**Blanking Plug**  
**DA8893**







Photo by Zoltan Tasi



# CAMPING



Great Gear  
For The Perfect Getaway



### Electric Fridge Freezers



## 4X4 ACCESSORIES

ARB products available in the UK only.



<p><i>A perfect electric fridge freezer for any travelling adventure</i></p>	<p><b>10801353</b> <b>35 Litre ARB Electric Fridge Freezer</b></p> <p><i>Great for short trips or as a second electric fridge freezer, the 35L electric fridge freezer suits many compact SUV's due to its low height and small footprint.</i></p>	<p><b>10801473</b> <b>47 Litre ARB Electric Fridge Freezer</b></p> <p><i>Suitable for many medium to large SUV's, the class leading 47L ARB electric fridge freezer is your perfect travelling companion.</i></p>
	Capacity	35 litres (50 x 375ml cans)
Cooling Capacity	-18°C to +10°C	
Weight	20.7kg	22.5kg
External Dimensions - (H) x (W) x (D)	428 x 380 x 705mm	508 x 380 x 705mm
Fruit & Dairy Compartment - (H) x (W) x (D)	126 x 285 x 151mm	206 x 285 x 151mm
Main Compartment - (H) x (W) x (D)	321 x 285 x 337mm	401 x 285 x 337mm
Power	Built-in 12/24V DC and 100-240V AC power with integrated battery protection system	
Transit Bag	<b>10900042</b>	<b>10900043</b>
Fridge Freezer 12V DC Power Cable	<b>10910076</b>	<b>10910076</b>
Fridge Freezer Tie-down Kit	<b>10900010</b>	<b>10900010</b>
Fridge Freezer Slide - Standard	<b>10900021</b>	<b>10900021</b>
Fridge Freezer Slide - Full Extension	<b>10900029</b>	<b>10900029</b>

#### Internal features

- > **Dairy compartment** - optimised internal capacity includes separate compartment for fruit and dairy products
- > **Reversible basket with divider** - multiple storage options by separating fridge freezer contents or alternatively allowing longer items to be positioned along the length of the cabinet
- > **Drain plug** - integrated into fridge freezer base for effortless cleaning
- > **Integrated evaporator** - designed as an integral part of the interior cabinet, ensuring simplified cleaning and optimum use of internal storage space
- > **Internal LED light** - low power draw LED light with magnetic switch turns off when lid is closed

#### External features

- > **Secop compressor** - highest quality, Secop Compressor with smart electronic control system enables rapid cool down to target temperature
- > **Durable detent hinge** - stainless steel detent hinge ensures the lid can be easily released and securely slid back into place
- > **Rear clips** - rear clips secure 12/24V and 100-240V cables, preventing the plug from being accidentally disconnected
- > **Lid with integrated seal** - tough, two piece injection moulded lid incorporates a recessed seal, preventing excessive wear and damage
- > **Front latch** - simple to use, large over-centre cam lock latch provides a positive seal between the lid and cabinet for maximum cooling efficiency
- > **Control panel** - easily accessible, recessed front control panel with maintenance-free digital temperature display (no dedicated battery required)
- > **Recessed handles** - powder coated steel handles, engineered to double as tie down points
- > **Durable case** - powder coated, robust zinc steel cabinet sides designed to withstand extreme off road conditions
- > **Rubber feet** - integrated into fridge freezer base for increased grip and stability

#### CONTROL BY APP



#### Overview

The tried and proven ARB fridge freezer has been keeping food and drinks cold for many years now they've been given a fresh new look and some cool little upgrades! One of the most exciting updates is the free transmitter module which allows remote display and control via an Android or Apple Smartphone or ARB LINX device. A colour scheme inspired by the ARB Jack, the gun-metal fridge freezer body contrasts perfectly with the black plastics and will look right at home in the back of a wagon, underneath an ARB Canopy. See all the updates, features and benefits of these fridge freezer - [www.britpart.com/chill](http://www.britpart.com/chill)

#### Communication

A transmitting module has been introduced that utilises Bluetooth® connectivity allowing both monitoring and control of your Series 2 fridge freezer. Whether you're in the driver's seat or relaxing in your camp chair, keeping an eye on the temperature of your beers has never been so easy - it can all be done on your Apple or Android Smartphone or ARB LINX device. For existing ARB fridge freezer owners, the transmitter is also backwards compatible on any ARB fridge freezer manufactured post 2014 however, functionality is limited to display only - see website for more details.



More information is available online at [www.britpart.com](http://www.britpart.com)

#### DA8933

##### ARB Remote Electric Fridge Freezer Monitor

Allows you to monitor the operating condition of your ARB fridge freezer from the comfort of your driving seat.

- > Multiple receiving channels for minimised transmission disruptions
- > Large easy viewing backlit display
- > Ability to monitor 2 ARB fridge freezers
- > 30m line of sight or 15m interrupted transmission
- > Quick release bracket for easy removal of LCD display
- > Temperature displayed in either °C or °F
- > Power supply 12V



##### ARB Electric Fridge Freezer Transit Bags

Shields your electric fridge freezer from dents and scratches while also providing additional insulation in extreme temperatures. Made of tough, durable canvas, the functional ARB transit bag features a handy side pocket for items such as the power cord or instruction booklet, as well as openings for the fridge freezer's rubber feet, power cables and drain plug hole. And most importantly, includes an ARB bottle opener!

**Electric Fridge Freezers**



**4X4 ACCESSORIES**

ARB products available in the UK only.



	<b>10802363</b> 36 Litre - ARB Single Zone Electric Fridge Freezer	<b>10802443</b> 44 Litre - ARB Single Zone Electric Fridge Freezer	<b>10802603</b> 60 Litre - ARB Single Zone Electric Fridge Freezer	<b>10802693</b> 69 Litre - ARB Dual Zone (24L/45L) Electric Fridge Freezer	<b>10802963</b> 96 Litre - ARB Dual Zone (41L/55L) Electric Fridge Freezer
<b>Capacity</b>	36 litres (47 x 375ml cans)	44 litres (65 x 375ml cans)	60 litres (96 x 375ml cans)	69 litres (87 x 375ml cans with divider, 108 without)	96 litres (144 x 375ml cans)
<b>Cooling Capacity</b>	-22°C to +10°C				
<b>Weight</b>	22.2kg	23.9kg	28.0kg	31.0kg	36.6kg
<b>External - (L) x (W) x (H)</b>	675 x 423 x 436mm	675 x 423 x 496mm	755 x 469 x 496mm	755 x 469 x 564mm	935 x 548 x 509mm
<b>Internal - Upper - (L) x (W) x (H)</b>	482 x 292 x 143mm	482 x 292 x 203mm	580 x 326 x 197mm	380 x 326 x 264mm	354 x 403 x 209mm
<b>Internal - Lower - (L) x (W) x (H)</b>	316 x 292 x 180mm	316 x 292 x 180mm	402 x 326 x 180mm	202 x 326 x 180mm	176 x 403 x 180mm
<b>Internal - Rear Zone - (L) x (W) x (H)</b>	N/A	N/A	N/A	170 x 326 x 444mm	354 x 403 x 389mm
<b>Power</b>	12/24V DC / 100-240V AC Integrated battery protection system				
<b>Current Draw</b>	0.8Ah*	0.8Ah*	0.8Ah*	2.9Ah**	3.1Ah***
<b>Transmitting Module</b>	Bluetooth connectivity allows 2-way communication on your mobile device				
<b>Features</b> More information & images on these electric fridge freezers & accessories available at <a href="http://www.britpart.com/chill">www.britpart.com/chill</a>	<ul style="list-style-type: none"> <li>&gt; Front opening, quick release lid</li> <li>&gt; Removable upper basket with built-in folding access door</li> </ul>	<ul style="list-style-type: none"> <li>&gt; Front opening, quick release lid</li> <li>&gt; Removable upper basket with built-in folding access door</li> </ul>	<ul style="list-style-type: none"> <li>&gt; Side opening, reversible, quick release lid</li> <li>&gt; Removable upper basket with built-in folding access door</li> </ul>	<ul style="list-style-type: none"> <li>&gt; Side opening, reversible, quick release lid</li> <li>&gt; Dual, independently controlled compartments</li> <li>&gt; Removable compartment lid</li> <li>&gt; Removable compartment divider</li> <li>&gt; Removable basket with built-in folding access door</li> </ul>	<ul style="list-style-type: none"> <li>&gt; Individual compartment, reversible, quick release lids</li> <li>&gt; Single, removable basket for zone 2</li> <li>&gt; Removable upper &amp; lower basket with built-in folding access door</li> <li>&gt; Dual independently controlled cooling zones</li> <li>&gt; Separate zone LED, auto switched light</li> </ul>

**Zero Electric Fridge Freezer Range**

- > Dual, independently controlled cooling zones (dual zone models only)
- > Each zone can be set to fridge, freezer or off
- > Removable compartment divider and internal lid (69L dual zone only)
- > Integrated wireless monitoring & control via compatible Bluetooth enabled devices (LINX, Android & IOS)
- > Boost function for rapid cool down
- > Anti-condensation technology
- > Highly efficient, variable-speed compressor
- > Convenient USB 5V, 3000mA outlet for charging phones and alike (fridge freezer must be connected to DC or AC power source for charging)
- > Dual DC power inlet at opposing ends for customised installations
- > Front AC power inlet for quick home or powered site connection
- > Tough, durable steel outer casing
- > Full height corner mouldings for added protection
- > Recessed carry handles with integrated tie down points
- > Quick release, front opening lid with non-slip glass/bottle provision (44L only)
- > Quick release, reversible, side opening lid/s with non-slip glass/bottle provision (60L, 69L & 96L)
- > Easy-view LED display
- > Low power draw LED interior light/s
- > Versatile, removable internal basket system with provision for tall items/bottles



10900054

- 10900055 NEW** 36L Zero fridge freezer transit bag
- 10900051** 44L Zero fridge freezer transit bag
- 10900052** 60L Zero fridge freezer transit bag
- 10900053** 69L Zero fridge freezer transit bag
- 10900054** 96L Zero fridge freezer transit bag

**ARB Zero Electric Fridge Freezer Transit Bags**

Keep your ARB Zero electric fridge freezer looking like new and performing to its maximum potential with a sleek & stylish Transit Bag. Designed to protect the fridge freezer from dents and scratches whilst improving cooling efficiency with its added layer of insulation, the ARB Zero Transit Bag is a great way to protect your investment!

- > Made from tough, durable 100% polyester
- > Easy-fit design
- > Improves fridge freezer cooling efficiency
- > Magnetic lid flaps for seamless integration and convenient fridge freezer access
- > 2-piece design for side opening fridge freezer
- > Allows simple, reversible lid operation
- > Single piece design for front opening fridge freezers
- > Power cord retention system
- > Dual side storage zip pockets
- > Unobstructed fridge freezer control panel
- > Bonus included bottle opener with integrated pocket

**Electric Fridge Freezer Slides**

- > Secure, versatile mounting solution for your Zero fridge freezer
- > Suitable for installation on either passenger or driver's side of vehicle
- > Solid steel construction with zinc plating and black e-coated for superior durability
- > Sealed, heavy duty roller bearings deliver smooth operation and prevent dust and grit ingress
- > Clear access to the drain port of your fridge freezer
- > Quick release locking catch can be positioned on left or right hand side of the slide for ease of use
- > Slide can be locked in the open or closed position
- > Integrated feet locators to keep the fridge freezer secure whilst in transit
- > Tie down provision for securing the fridge freezer to the slide
- > Compact design to minimize cargo intrusion

**Note:** Fridge freezer slide is not suitable for the Zero 96L

**10900047**

Slide for ARB Zero 36L & 44L fridge freezer External (closed): 747 L x 444 W x 79mm H External (open): 1,305mm L Sliding Tray: 731 L x 404 W x 66mm H Weight: 15kg / Net Payload: 75kg

**10900048**

Slide for ARB Zero 60L & 69L fridge freezer - full extension External (closed): 946 L x 444 W x 79mm H External (open): 1,669 L Sliding Tray: 930mm L x 404 W x 66mm H Weight: 18kg Net Payload: 120kg (main tray), 40kg (accessory tray)



**Zero Electric Fridge Freezer Wireless Monitor & Control**

Monitor and control your Zero electric fridge freezer on LINX\* or a compatible Bluetooth enabled device

**Displays**

- > Target and cabinet temperatures (multi-zone for dual zone models),
- > Compressor status (run, boost, idle & standby)
- > Battery voltage
- > Mode setting (up to 3 different user defined modes)
- > Fridge freezer name (user defined)

**Controls**

- > Turn on/off
- > Fridge freezer temperature (either by selecting pre-defined user mode/s or manually setting temperature)

**10900049 NEW**

**ARB Electric Fridge Freezer Power Pack**

- Keeping your ARB Zero fridge freezer powered so your food and drinks remain cold without the need to be hooked up to your vehicle. The lightweight ARB Power Pack features a 15Ah lithium battery for up to 18 hours runtime. Operation is quick and easy - after conveniently attaching the pack to your fridge freezer via high-power rubberised magnets, connect the power cable to the DC outlet, press the on/off button and you're good to go!
- > 15Ah lithium battery
  - > Integrated high-power rubberised magnets for secure mounting to the fridge freezer
  - > Battery level LED display for easy viewing
  - > Fully charged in 5-6 hours from complete discharge
  - > IP66 waterproof/dustproof rating
  - > EU market approved - CB: IEC62133 certified



*More information available online*

**Electric Fridge Freezer Tie Down Kit**

**10900046**

- > Stainless steel mount brackets with embossed branding
- > Quick release buckles
- > Includes all mounting hardware to suit ARB Zero fridge freezer slides
- > Compatible with all ARB Zero fridge freezers



\*DC12V set at 5°C, 32°C ambient temperature. \*\*DC12V set at -15°C zone 1, 3°C zone 2, 32°C ambient temperature \*\*\*12VDC set at -15°C zone 1, 3°C zone 2, 32°C ambient temperature



# CAMPING

## Food Storage

### Electric Fridge Freezers

#### DA1468 60L Elements Weatherproof ARB Electric Fridge Freezer

Capacity 60 litres  
Cooling capacity -18°C to +10°C  
Weight 31.8kg  
External dimensions 435 H x 490 W x 820mm D  
Packed with the features an ARB electric fridge freezer is renowned for and re-engineered to survive out in the elements. ARB's Elements is packed with unique features that not only protect and secure, but also make accessing your food and drinks even easier. ARB's 'No Holds Barred' approach saw their engineers include features previously left on the cutting room floor. To read more about this fridge freezer go to - [www.britpart.com/DA1468](http://www.britpart.com/DA1468)

Elements Accessories - more details online

10900038	Tie-down kit
10900039	Solid mount kit
10900040	Slide mount kit



The Ultimate 4WDer's Fridge Freezer... Reinvented



10900039



10900040



10900038



### Cool Bags



#### 10100376

**ARB Cooler Bag**  
360 x 270 x 220mm  
With ice retention of up to 12hrs and included plastic cooler brick, keep your food fresh and drinks cooler for longer. The space-saving design allows the ARB Cooler bag to be folded flat for easy stowing. Meanwhile, the internal foil lining ensures the bag is well insulated. With the included durable comfortable handles that make carrying a breeze.

10500994  
Retro fit shoulder strap

- > PVC outer shell
- > Plastic ice brick
- > Storage pockets
- > Internal foil liner
- > Compression hooks
- > Gear loops & bottle opener
- > Holds 22 Cans (330 ml) & ice
- > Hard base

#### VPLZS0529LR NEW

**Electric Cool Bag**  
Thermostatically controlled temperature. Easy clean interior surfaces. Vertical space for standing 2-litre bottles. Exterior in high quality Oxford nylon, side in hard-wearing rubber coated nylon.

- > Application: 12 volts auxiliary socket
- > Power input: Approx. 3 A/36 W
- > Capacity: 14 litres
- > Cooling capacity: Max. 25°C below ambient temp
- > Insulation: 20mm solid polyurethane foam; 10mm expanded foam
- > Cooling unit: Thermoelectric elements, cooling only
- > Size: Height 380mm, Length 380mm, Width 220mm



### Toastie Brander



#### ARB4206

The ARB Toastie Brander is designed to make toasted sandwiches on the coals of an open fire or portable burner. Consisting of two cast iron plates with handles formed from Manchurian Ash timber. The Toastie Brander can cook a variety of sandwiches and as the name suggests, brands the ARB logo onto both sides of the sandwich. Supplied with canvas case.

### Tents, Awnings & Shelters

#### Tent & Awning Pegs



#### ARB4158A ARB Supergrip Sand Pegs

- > 4 pegs per pack
- > 370mm length
- > Polycarbonate construction
- > Multiple attachment points
- > Bright orange for best visibility
- > 80.5g each

With a unique head design, the ARB Super Grip Sand Pegs are able to grip more than traditional pegs in surfaces such as soft soil, sand and snow. Made from strong & durable polycarbonate, the pegs will handle the strong winds to sudden gusts. Packing up camp, the bright orange colour makes them super easy to find as well as reducing the potential to trip over them.

#### ARB4159A ARB Guy Rope Set With Carabiner

- > 2 per pack
- > Spring tensioner
- > Aluminium toggle/tensioner
- > Aluminium carabiner - 50kg rating
- > Reflective rope for easy sight at night
- > 108g each

The spring-loaded tensioning system, featuring a heavy-duty spring, helps absorb shocks to the pegs in windy conditions, this in turn ensures your guy ropes stay taut and the peg isn't pulled from the ground. Ideal for use with the ARB awnings as the aluminium carabiner allows it to be simply and easily clipped on to the awning. The ropes also feature reflective sections to help with visibility at night.

ARB Awnings & Accessories



**Awning**  
**DA6828** 1,250 x 2,100mm  
 Easy to mount and operate, these self standing, retractable awnings fit onto the side of a roof rack and are conveniently stored for immediate use on arrival. Specifically designed for harsh outback conditions, the awnings feature height adjustable, telescopic legs and provide fast and convenient protection from the elements. Easily mounting to the side of most roof racks or roof bars, the awning is secured in a heavy duty nylon reinforced PVC bag. Constructed from tough PU coated 300gsm poly/cotton rip stop canvas, the awnings are fully waterproof and offer a UVP 50+ rating. **Note** - You may also need awning fitting brackets - 813401 or 813402 or quick release brackets.



**Awnings & Light Kit**  
**814406** 2,000 x 2,500mm  
**814407** 2,500 x 2,500mm

When touring or camping, having adequate lighting is one of the most important items needed for any trip. Having good bright light, in the right spot and not in your eyes, will further enhance your overnight experience in the great outdoors.

Introducing the ARB awning and light kit, an LED light strip is incorporated into the awning roof. Just like in your home, good quality lighting is in the ceiling, not the walls - therefore placing the light right where it's needed and not harshly in your eyes is important. The slim dimensions of the LED light strip simplifies pack up. The light is rolled up with the awning roof after use and not removed, keeping everything together for your next adventure (make sure the joining cable hangs out about 10cm from the sleeve).

*LED light strip is incorporated into the awning roof*



The ARB awning light provides up to 1200 lumens with a choice of either cool white or amber colour mode and is dimmable via a waterproof digital dimmer switch.

Building a high performance light into the roof came with some challenges. One was making sure we could get the LED strip small enough as well as making sure we could keep them cool so they would not de-rate and dim prematurely. This has been achieved by using quality LED chips that can handle more heat than a standard strip light and also attaching the strip light to an aluminium track for heat dissipation, all sealed in a water tight resin.

Colour feature: Amber mode provides low bug attractant qualities or to provide comfortable late-night soft lighting when out camping or touring with current draw at 1 amp hour.

The light is powered via a fused cigarette lighter plug, with an additional 4 meters of insulated water proof cable and connectors, so the awning can be mounted on either side of your vehicle. Included with the wiring is a handy storage bag to keep all your cables together when the light is not in use.

Remember, using the appropriate ARB Quick Release Bracket for the awnings, you can now correctly mount the ARB 2.5m Awning to any dual cab trade rack.



**Windbreaks**  
**DA6829** 2,500mm Front wind break  
**DA6840** 2,000mm Front wind break  
**813300** 1,250mm Front wind break  
**DA6844** 2,400mm Side wind break  
 Suitable for 2,000mm and 2,500mm awnings only.  
 Not suitable for 1,250mm awning (DA6828).

Designed to angle out from ARB awnings, these wind breaks offer additional protection from the rain while also providing extra shade and sun protection. ARB wind breaks are ideal for creating extra protection and storage for items like swags and chairs under the awning. Manufactured from lightweight PU coated 300gsm poly cotton canvas. Waterproof and UV protected with a UVP 50+ rating. Tie down points for each wind break to further secure the awning.

**Note** - Awning not included.



**Deluxe Awning Alcoves**  
**813209 NEW** 2,000mm  
**813109 NEW** 2,500mm  
 Provides a practical solution to protect you from the elements, in many applications and environments. Whether it's an enclosed shelter for your swag, verandah for the table and chairs or protected space for storage, this alcove is sure to provide a versatile solution against the sun, rain, wind and light. Produced in line with ARB's existing Touring lineup, it features a high density 175GSM polyester ripstop canvas. It is also fire retardant for global markets and includes a durable multi-mesh mat. More information and images available online.



**4X4 ACCESSORIES**

ARB products available in the UK only.



**Awning Room with Floor**  
**DA6832** 2,500 x 2,100mm  
 Designed to function as a fully enclosed room, the awning with floor provides additional weather protection and privacy. The awning room can be used with ARB awnings and features a durable floor, two large mesh windows with roll up blinds and a zippered door with both solid and mesh panels. It is fully enclosed with an integrated roof that hangs just below the main awning canvas. Rear wall features a central door that can be used to directly access the vehicle rear door or canopy depending on awning mounting position. Access points for 12v/240v power leads. Supplied with hardened steel pegs and adjustable tension straps.



**Mosquito Net**  
**DA6831** 2,000 x 2,500mm  
 ARB mosquito nets are manufactured from double stitched, 48gsm midge proof mesh and are available for ARB awnings. Providing a comfortable area to eat and relax, this updated version is now larger and includes a mud/storm flap to reduce grass seeds and other debris from collecting in the lower section of the mesh. Hardened steel pegs are supplied to firmly anchor the room to the ground via adjustable tension straps.

- Features & Benefits**
- > 300gsm awning roof material - Heavy-duty to withstand the elements, mould proof treated, provides excellent UV reduction, one of the highest in class
  - > 1,000mm water head rating - Excellent water proofing
  - > 25mm aluminium poles and arms @ 1.2mm thickness - Superior strength and one of the thickest in the market
  - > 1000D PVC carry bag - Excellent abrasion and UV rating
  - > Welded and heat tape seamed seams - Quality built
  - > Flexible arm joints - Reduce stress and cracking
  - > 1200 lumen, high heat resistant LED's with aluminium extrusion for heat dissipation
  - > Water resistant digital dimmer control - Dimmer rated to IP56
  - > Cool white LED mode - Great for cooking and preparation
  - > Amber LED mode - Great to reduce bugs and mood lighting
  - > Additional cable storage bag provided for when not in use
- Note** - You may also need awning fitting brackets - 813401 or 813402 or quick release brackets.



**Three Wall Set**  
**DA6834** 2,500 x 2,100mm  
 Comprised of three individual walls that wrap around the outside of ARB awning legs, the three wall set is both waterproof and UV protected. Manufactured from lightweight PU coated 300D Oxford polyester, two walls feature windows made from half mesh and half clear PVC, while the right hand wall includes a zippered door that can be rolled up out of the way. Connected via a zip, each wall can be used individually, as a pair or set. Available to suit ARB awnings. Supplied with hardened steel pegs and adjustable tension straps. No rear wall allows for full access to the vehicle. Mud/storm flaps at the bottom of each wall.



### ARB Awnings & Accessories



#### Deluxe Awning Room with Floor

- DA1465** 2,000 x 2,500mm
- DA1466** 2,500 x 2,500mm

Designed to function as a fully enclosed room or mosquito net, the ARB deluxe awning room with floor provides protection from the weather, insects and provides additional privacy. Easy and quick to set up the ARB deluxe awning room can be used with 2500 and 2000 model awnings and features a durable waterproof floor and its own separate ceiling to help keep you cooler. All main wall panels incorporate zipper operated two way solid and mesh access doors for easy access and to accommodate changing weather conditions. Vehicle wall is solid zipper wall only.

- > Keep dry with waterproof walls made from Oxford Polyester
- > Long product life and sun protection thanks to UV treated materials
- > Enjoy a 'bug-free' environment with ultra-fine insect mesh
- > Heavy duty yet lightweight waterproof floor means a dry ground and compact storage
- > Organiser pockets perfect for phones, magazines and sunblock
- > Comes complete with guy ropes and steel pegs
- > Cable access ports for high mounted lighting solutions

**Note** - Kit does not include the awning. You may also need awning fitting brackets - 813401 or 813402 or quick release brackets.

		Kit 1	Kit 3	Kit 4	Kit 5
Small Cage Rack 2 Mount Points	Side		✓		✓
	Rear		✓		
Medium Cage Rack 3 Mount Points	Side		✓		✓
	Rear		✓		
Large Cage Rack 4 Mount Points	Side		✓		✓
	Rear		✓		
Touring Roof Rack 3 Mount Points	Side	✓			
	Rear				
Trade Roof Rack 2 Mount Points	Side		✓		✓
	Rear				
Trade Roof Rack 3 Mount Points	Side		✓		✓
	Rear				
Flat Roof Rack 2 Mount Points	Side				
	Rear			✓	
Flat Roof Rack 3 Mount Points	Side	✓			
	Rear			✓	
Classic Canopy Rack	Side		✓		
	Rear			✓	
Ascent Canopy Rack	Side		✓		
	Rear			✓	
Competitor Roof Rack Bracket Fit	Side				✓
	Rear				

- > Made from powder coated 3mm steel
- > Zinc plating to reduce abrasion
- > Quality hardware used
- > Easy setup and removal
- > Styling to match ARB roof racks

- > No drilling required
- > Allows 2.5m awnings attachment for dual cabs
- > Suitable for all ARB Awnings and some other makes



**813405**  
ARB quick release awning bracket - kit 1 with levelling plate

**813407**  
ARB quick release awning bracket - kit 3



**813408**  
ARB quick release awning bracket - kit 4

**813409**  
ARB quick release awning bracket - kit 5

#### ARB Quick Release Awning Brackets

Going one step further with your awning attachments is to have a quick release option. The ability to quickly unbolt your awning for storage or alternatively moving it to a different mounting place is now easier with the ARB quick release awning brackets.

The ARB quick release brackets provide excellent mounting options for all ARB awnings to their roof racks and cages. They provide the correct mounting and in nearly all cases with no drilling or modifications required to mount.

The ARB quick release brackets are easily removable via a simple one bolt configuration. This allows for storage of the awning when it is not required on the vehicle, or the ability to move the awning between vehicles which further expands the versatility of the ARB awning.

Installing the Kit 4 bracket to the rear of the roof rack/cages allows your awning to be moved from the side of your vehicle to the rear of your vehicle in minutes when you are setting up for camping. This provides up to 2.5m of awning space at the rear of the vehicle. The awning will need to be moved back to the side of the vehicle while in transit.

Dual cab mounting with Kit 3 allows a full 2.5m awning to be fitted to the side of dual cabs with the correct 700mm overhang to be adhered too. ARB quick release brackets also provide excellent mounting options for wagons providing strength and durability where required.

Removing the awning when not required allows for reduced weight on the vehicle and additional security when the awning is not required.



#### ARB Aluminium Encased Awnings

- 814102** 2,500 x 2,500mm  
Natural aluminium finish
- 814408** 2,500 x 2,500mm  
with LED lights  
Natural aluminium finish
- 814412** 2,500 x 2,500mm  
with LED lights  
Black aluminium finish

The three quick release bungee cords remove the need for zips while the flip-up lid provides unmatched simplicity. An added abrasion resistant material improves the protection of our proven 300gsm, PU coated, fully waterproofed and UV protected canvas while stowed and travelling. The awning is supported by heavy duty 1.2mm gauge x 25mm expandable aluminium poles, anodised for greater corrosion resistance and perfect for setting up by the beach.

- > Aluminium housing offers strength and modern styling
- > Quick release bungee cords on a hinged lid for unmatched simplicity
- > Anodised aluminium for corrosion resistance, perfect for the beach
- > PU coated canvas provides a 100% waterproof overhead shelter
- > Ripstop canvas, a cross-hatched design, improves strength
- > Heavy-duty poles for greater resistance to poor weather conditions
- > Compatible with awning rooms, wind breaks

**Note** - You may also need awning fitting brackets - 813401 or 813402 or quick release brackets.



Complementing the design and sophistication of modern 4WDs, ARB's aluminium encased awnings offers a sleek and contemporary alternative to traditional awning covers while adding improved functionality.

#### ARB Awning Brackets

**813402**  
Designed with welded gussets to provide additional strength when awnings are mounted to roof bars on vehicles used off-road or under extreme conditions. Single.

**813401**  
Galvanised bracket bolts directly to roof bar or flat roof rack panel for a simple awning fitment. Single.

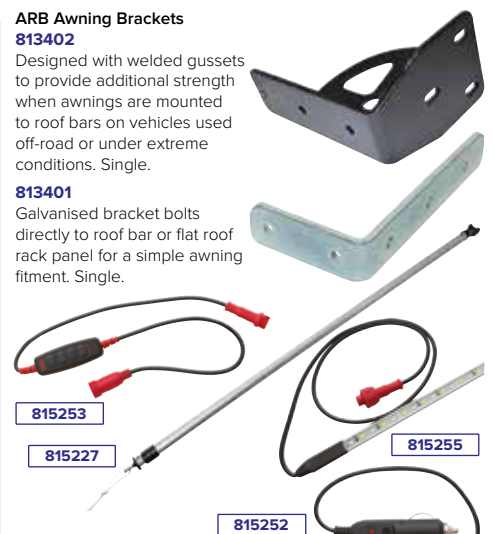

#### ARB Awning Replacement Parts - more images online

- 815227** ARB awning leg - full
- 815230** ARB awning arm - 2,500mm
- 815206** ARB awning cover - 2,500mm
- 815248 NEW** ARB Awning zipper - 2,500mm
- 815255 NEW** ARB LED light strip
- 815253 NEW** ARB LED dimmer
- 815252 NEW** ARB spare cigar socket cable
- 815254 NEW** ARB extension cable

## ARB Tents

**802200 NEW****ARB Esperance Rooftop Tent***Compact. Hardshell. Lightweight. Contemporary Design.*

Drawing heritage from the beautiful beaches and crystal-clear waters of one of Western Australia's most renowned coastal environments, the Esperance RTT now expands the ARB rooftop tent family into a super lightweight, slimline and contemporary looking hard shell.

With the brief focused on quick and effortless setup/pack up times, features like an internal telescopic ladder, gas strut assisted opening and only 3 push lock ratchet straps keep travelling a breeze. Not only does Esperance look great at camp but the unique shell design and colour tone also compliments vehicles while packed up.

**Lift, Pull & Rest**

- > Setting up is as simple as unclamping the cover, lifting it up, and folding out the tent via a pull
- > Can be packed up with compact bedding left inside
- > Internally stored telescopic ladder

**Roomy & Comfy Interior**

- > When set-up, enjoy a large overall internal bed space: 1520mm (L) x 2000mm (W) x 1200mm (H at centre)
- > 40mm thick, high-density sponge with a quilted polyester peach skin mattress cover that's removable for washing
- > Manage airflow via the 3 zippered windows featuring dual midge-proof mesh screen
- > Stargazing moonroof

**Extra Protection**

- > Wind resistant, slimline shell design that has been designed with a streamlined mould
- > Stainless steel hardware for long term durability
- > Canvas is made from 200GSM poly cotton fire retardant with a silver coated 2m water head
- > Fly is made from removable 210D fire retardant canvas, with silver coated 3m water head

**Handy Features**

- > Features an internal dimmable LED strip light with concealed cables
- > External LED strip lighting to help you out late at night
- > Includes internal storage pockets, shoe pockets, cargo pockets, mounting kit and hardware

**Specifications**

- > Packed Dimensions - 1,520mm (L) x 1,220mm (W) x 330mm (H)
- > Open Dimensions - 1,520mm (L) x 2,000mm (W) x 1,200mm (H)
- > Weight - 56kg dry (approximately)
- > Sleep Persons - 2 adults & 1 child
- > Tent Weight Limit - 500kg
- > Ladder Weight Limit - 150kgs
- > Shell Material - ABS with acrylic compound material
- > Mattress - 40mm, high density sponge
- > Mattress Cover - 3-layers quilt polyester peach skin
- > Fabric of Rain Cover - PU300mm, UV50+, PU+silver plating, Oxford, 210D, FR free
- > Fabric of Main Tent - PU300mm, UV50+, PU+silver plating, poly-cotton canvas, 200g, FR free
- > Mesh - 100% polyester, 50g/m<sup>2</sup>, 68D
- > Roof Rack/Cross Bars requirement - Your roof rack and cross bars MUST have load limit over 75kg. Your cross bars MUST be at least 760mm apart and height is less than 40mm. Please consult your vehicle's manufacturer regarding the load limit.
- > Speed Limit - The recommended speed limit to not exceed when having the tent on your vehicle is 68 mph. Driving speed should always be adjusted according to the current driving conditions, such as road type and quality, weather (wind conditions, rain), and applicable state speed limits.

**803300****ARB Flinders Rooftop Tent***Compact Without Compromising On Camping Comfort*

With a quick set-up and pack-up as well as the added practicality of storing all your bedding inside, with the ARB Flinders rooftop tent you're one fold away from a good night's sleep in a comfortable space that'll go wherever you and your 4WD take it!

Spacious inside with 3 surrounding zipper windows, a skylight-style roof and built-in internal light and USB charging port, the Flinders rooftop tent is conveniently compact on the outside with a lower packed height for reduced wind drag and less added height to your vehicle.

**Easy Set-Up & Hassle-Free Pack Down**

- > Set up and pack down is simplified thanks to the zipped cover which does not have to be removed
- > Setting up is as simple as unzipping the cover, opening out the tent using the ladder and sliding the expendable poles into position – all internal poles will intuitively fan out into place
- > Packing down is easy via 2 internal bungee lines to help pull the sides of the tent in as it folds down

**Internal Light, USB Charging Points & Storage Pockets**

- > Features an LED touch lamp and 2 x USB charging points that can connect to a vehicle's 12V outlet
- > Includes 4 storage pockets, shoe pockets, pack down bungee cords, 5m lighting cable extension, mounting kit and hardware

**Compact & Lower Profile**

- > The lower packed height of 200mm (without ladder affixed) results in reduced wind drag and adds less overall height to the vehicle
- > Compact size allows for improved aerodynamics as well as improved access to low roof areas and tracks with low canopies

**Removable ladder****Large Internal Space With Windows**

- > When set-up, enjoy a large overall internal bed space: 2400mm(L) x 1400mm (W) x 1,200mm (H at centre)
- > Manage airflow via the 5 zippered windows featuring dual midge-proof mesh screen
- > Rain and sun awning shelters to side windows and entrance
- > Integrated vent ensures maximum airflow and reduced condensation
- > Includes comfy 50mm high-density foam mattress with bedding retention straps

**Specifications**

- > Packed Dimensions - 1,400mm (L) x 1,200mm (W) x 200mm (H) (300mm H with ladder)
- > Open Dimensions - 1,400mm (L) x 2,400mm (W) x 1,400mm (H)
- > Weight - 56kg dry (approximately)
- > Canvas - 300gsm poly-cotton rip-stop canvas & 420D Oxford polyester fly for sunroof and window awnings
- > Outer cover - 600gsm heavy-duty grey PVC cover
- > Base - ABS laminated insulated aluminium internal frame
- > Frame - Internal metal camlock bows with 25mm diameter frame
- > Ladder - Aluminium sliding ladder - 120kg rating
- > Windows - 3 windows, 1 x door entry, a skylight and an all-weather ventilation port
- > Mesh - Midge proof mesh
- > Seams - Internal seam sealing and bar tack stitching on tensioned areas
- > Zips - Self-repairing coil zips
- > Lighting - 300 lumen LED touch lamp, 2 x USB sockets at 2.1A and 12V socket
- > Mattress - 50mm high-density foam mattress with bedding retention straps





### ARB Tents



**DA8981**  
**ARB Simpson Rooftop Tent & Annex**  
1,400 W x 2,400 L x 1,300mm H

The ARB Simpson III rooftop tent will provide the ultimate in ease and convenience when travelling. Unfolding in minutes, a rooftop tent provides sleeping quarters off the ground, protected from the elements. Spacious and comfortable, all bedding can remain inside the tent during the journey, freeing up vital storage space in the vehicle, and allowing the tent to be quickly and easily packed away. More images available online.

**Features**

- > Incorporates an updated design and new materials for better strength, rigidity and water resistance
- > Manufactured from high quality, poly/cotton fabric
- > Incorporates Oxford polyester flysheet with excellent water shedding ability
- > Sturdy aluminium retractable ladder
- > High density bonded chip foam mattress with removable cover for increased comfort and durability
- > Incorporates pull out veranda
- > Insect screened windows and door
- > UV stabilised laminated PVC cover
- > Bungee cord system to assist when closing
- > Easily mounted to ARB's purpose designed roof rack
- > Can be configured to unfold off either the side or off the rear of the vehicle
- > All aluminium components feature an anodized finish for improved corrosion resistance and appearance
- > Comes complete with mounting hardware, wrenches, ladder, travel cover and comprehensive instructions
- > ARB awnings can also be paired with the rooftop tent

**DA1419**  
Simpson Annex - available separately

**DA1463**  
ARB Simpson III ladder extension.

Made to the highest quality, providing a convenient solution for vehicles with a higher than normal rack height. Required when rack height is over 2m.

**815100**  
Replacement ARB Simpson III rooftop tent cover

**815118**  
ARB tent mounting fitting kit



**804402**  
**ARB Tent Shoe Pockets**

2 x elevated shoe pockets for convenient footwear storage that is within reach. Suitable for the ARB Simpson III roof tent. Attaches to the internal sail track.



**SDS102**  
**ARB SkyDome Single Swag Tent**  
2,150 L x 900 W x 450 to 800mm H  
Weight - 10.5kg



**SDS200** ARB SkyDome Double Swag Tent  
2,150 L x 1,400 W x 450 to 800mm H  
Weight - 14kg  
**SW002** ARB SkyDome Peg & Pole Kit  
Replacement peg & pole for SDS200 **NEW**

Incorporating the latest in swag design and comfort, the ARB SkyDome swag has been designed from the ground up to meet the exact needs of 4WDers and tourers alike. To counter the claustrophobic feeling caused by some swags, ARB's SkyDome range has been designed with very generous dimensions. The industry-leading height from head to hip allows occupants to move around freely and spread out without feelings of confinement. The large mesh areas provide excellent ventilation to reduce internal condensation, with additional canvas flaps and insect-proof mesh in the roof zone of the Series II improving cross-flow ventilation to enhance airflow and make it cooler and even more comfortable during warmer nights. The freestanding architecture means ARB SkyDome swag require no pegs or guy ropes when deployed on flat surfaces. Matched with waterproof materials and a high-density corrugated 75mm foam mattress, the SkyDome will ensure a dry and comfortable night's sleep in any conditions. Rain gutters to divert water from windows. Each tent has 4 x internal storage pockets, a torch holder and 2 x hanging hooks.

- > 500gsm - rot & mildew proofed canvas
- > High tensile wax coated core spun thread
- > Ultra-fine 135gsm midge proof mesh
- > 970gsm PVC base
- > 75mm corrugated foam with anti-microbial treatments
- > Improved air ventilation
- > Genuine no#10 YKK zippers with anti-corrosion
- > 11mm aluminium poles



## 4X4 ACCESSORIES

ARB products available in the UK only.

**ARB Cargo Gear SkyDome Swag Bags**

**10100385**  
Single SkyDome Swag  
1,000mm L x 450mm D

**10100390**  
Double SkyDome Swag  
1,500mm L x 450mm D

These ARB Cargo Gear bags have been developed specifically for storage and transit of the ARB SkyDome Swags. The bags feature moulded rubber carry handles on either end along with a removable shoulder strap. Unique to the swag bags are four adjustable tie down straps integrated into the bag to allow it to be secured to a roof rack without the need for additional straps.

- > Outer shell made from tough, Oxford weave PU coated fabric and rubber panelling
- > All seams are heat sealed and taped to ensure storm proofing
- > Roll up top closure with 'Sure Grip' buckles to create water resistant seal
- > Removable body curve shoulder strap
- > Grab handles on either end of bag



**BSWAG**

**ARB BootSwag**

When designing the range of SkyDome other swags, the boot mat found on numerous other swags was intentionally omitted due to the nature of these flaps getting dirty and soiling the swag when rolled up. The BootSwag is ARB's creative solution to this challenge and features a zippered front flap, large boot mat and a dome section made from waterproof Oxford fabric. Being a standalone item, the BootSwag can also be used with other touring products including the ARB roof top tents where it can be placed at the foot of the ladder.

Boot swag - 460 L x 500 W x 340mm H  
Boot mate - 580 L x 500mm W

- > Waterproof, heavy-duty PVC base and boot mat
- > Designed to protect footwear from the elements at night
- > Manufactured from PU coated Oxford polyester for optimum water shedding ability
- > Free standing design with 4 pegs included
- > Durable fibreglass bows and rod
- > YKK zipper and nickel plated brass eyelets for corrosion resistance
- > PU coated Oxford polyester storage bag

**803301 NEW**  
**ARB Tent Lighting Kit**

The perfect addition to any camping setup, ARB's Tent Light works seamlessly with a large range of rooftop tents and awnings. Simple to set up and featuring a touch-sensitive switch, the Tent Light helps to light up the night wherever you are, without needing to fumble for switches in the dark of night.

- > Light output 300 lumens dimmable light output
- > Suited to 25mm clamps to suit ARB Flinders, & ARB Simpson tents as well as other awnings and rooftop tents with 25mm poles
- > Current draw Up to 1A @ 12V for lighting from 12V cig plug
- > Power output Two USB ports (2.1A and 1A) and a 12V cig plug
- > Weather-resistance IP54 splash resistance and weather-resistant external plugs and fused 4m cable



**ARB Camping Chairs**



**DA8929**

**ARB Air Locker Camping Chair**

Rated to 120kg and has a host of features, including a padded seat and backrest, convenient drink holder pouch, side pocket with Velcro flap for your keys, wallet or other small items, and a mesh magazine pocket on the rear of the backrest. Manufactured from durable nylon Oxford weave material, the chair also comes with a matching carry bag for compact storage and transportation.



**10500101**

**ARB Camping Chair**

Rated to 150kg. The ARB camping chair is built with quality and comfort in mind. Made from durable nylon Oxford weave. The chair also features a convenient drink holder table, side pocket, additional drink holder pouch and mesh magazine pocket. The zippered storage bag features a shoulder strap making it easy to transport and is ideal for protecting the chair from dirt and dust when not in use.

More information available online



**10500131**

**ARB Compact Directors Chair**

Rated to 130kg. The ARB compact directors chair is the luxurious camping chair solution! The chair features Old Man Emu colours, full high back support, auto folding table with cup holder, padded armrests, safety lock out button, unique any-terrain legs, integrated fully PVC welded no leak cooler bag and an abundance of pockets and organisers which all fold neatly down into an easy pack carry bag.

**ARB Camping Table**



**10500130 ARB Compact Aluminium Camp Table**

The perfect size for packing neatly away into your vehicle, yet big enough to get a family of 4 around. Made from aluminium, the design utilises a full diameter aluminium slat providing a strong sturdy surface, as well as heat resistance for cooking preparation. A great place for dinners or another storage spot to keep your camp items off the ground. Cross braces are used to provide additional support providing a unique sturdiness not seen in similar tables. Pack up size is great which is all neatly stored away in a compact bag.

- > Table surface size - 860 L x 700 W x 700mm H
- > 22 x 22mm black anodised legs
- > 600D PVC back nylon carry bag
- > Table can hold up to 30kg when assembled
- > Unique table pins to keep table together if moved
- > Folds up easily for carrying and compact storage - 880 L x 210 W x 125mm H



**ARB Quick Fold Stretcher Bed**

**10500140**

**ARB Quick Fold Stretcher Bed**

Sometimes finding a soft place to set up your swag or tent is next to impossible. Anyone who's had to sleep on rocks can tell you that unless you're travelling with a pillowtop mattress, you're going to feel the ground all night. The ARB Stretcher has been developed for use underneath your swag or on its own, it features a quick-fold design for an almost instant set up, meaning you can set up in a snap, giving you more time to relax and enjoy your surroundings. When you're finished, the ARB Stretcher packs up quickly and easily, and stores into its rugged storage bag ready for your next adventure. An included strap with hooks secures your swag to the stretcher via the peg down points on the head end of your ARB swag and by using the included pack up/roll up straps sewn into the ARB swag you can secure the base. The quick-connect boot bag, supplied standard with the ARB Stretcher, keeps your boots and other essential items off the ground and safe from creepy crawlies.

- > Easy connect boot bag - great for storage of your boots and other personal items
- > Quick fold system makes pack up a breeze
- > Anti-rock feature to keep you steady and still for the entire night.
- > 600D nylon padded top, providing comfort and support
- > Heavy-duty steel frame
- > 600D nylon storage bag
- > Weight rating - 150kg
- > Pack weight - 12kg
- > Open size (LxWxH) - 2,110 x 820 x 460mm
- > Pack down size (LxWxH) - 1,050 x 210 x 210mm







10500070

10500070

### ARB Pureview 800 Torch

The ARB Pureview Torch 800 is a rugged and versatile torch. With a beam distance of up to 300m, this torch provides excellent distance.

#### Features & Benefits

- > 800 lumens
- > LUMINUS® SST40 with 50,000hr life span
- > 300m beam distance
- > 2600mah 18650 li-ion battery
- > High, medium, low & strobe
- > 5000-8300k colour temp
- > 800 lumens high - 1.5 hours runtime
- > 400 lumens medium - 4 hours runtime
- > 200 lumens low - 7 hours runtime
- > Strobe - 20 hours runtime
- > Hidden micro USB charge port internal charging with charge indicator
- > IP55 dust/mud/water resistant
- > Polycarbonate shatter-proof lens
- > Quality braided USB cable
- > Tested to world standard ANSI ratings
- > Aircraft grade anodised aluminium
- > Includes lanyard and magnetic belt pouch
- > Laser etched ARB logos

#### Technical Specifications

- > Beam distance - 300m/984ft
- > Lumens - 800 high, 400 medium, 200 low
- > LED type - LUMINUS® SST40
- > Battery - 3.7V 2600mah 18650 li-ion battery
- > Runtime - 8 hours - low, 4 hours - medium, 1.5 hours - high & 20 hours - strobe
- > IP rating - IP55 (Dust/mud & high-pressure water resistant)
- > Charge time - Up to 4 hours via USB charge cable
- > Accessories - Micro USB high current braided cable, belt pouch
- > Certificates - CE & RCM(SAA)

More information about these ARB torches is available online at [www.britpart.com](http://www.britpart.com)

### 10500050 ARB LED Head Light

- > Up to seven hours run time, the head light
- > Comfortable adjustable elastic head band
- > Adjustable hinge for vertical beam adjustment
- > Focus adjustment for wide or narrow beam
- > Three lighting modes: 300 lumen beam or flashing mode
- > Anodised aluminium body
- > Weight - 162g



10500050



## 4X4 ACCESSORIES

ARB products available in the UK only.



### 215717 Old Man Emu NitroLight Pack Mini LED Light

- > Compact & lightweight
- > Cordless rechargeable battery
- > 20 LED lights
- > Up to 2 hours run time full power & 4 hours half power
- > 12V DC lead and adaptor
- > 400 lumen & 10W output
- > Dual magnetic mounts & single hook mount
- > Water & shock resistant
- > LED life expectancy of 50,000 hours

#### LED Head Torch

- > 5W CREE LED light
- > Aluminium body
- > Three light functions
- > Adjustable elastic strap
- > Batteries included
- > Adjustable beam width
- > Light colour - 6500K



10500085

### ARB Horizon Area Light

Great for additional lighting around the campsite or for those unfortunate breakdowns. Having the ability to charge the battery and run the light at the same

time is a big plus to withdraw limits on battery capacity.

- > 4000mAh @ 5V power bank
- > Li-Ion battery - 7V
- > Lumens - 1000/2000 Lumens
- > High powered COB LED - Flood light beam
- > High pressure die-cast aluminium body
- > 2-4hr Run time on battery (high to low)
- > Charge & run at the same time
- > In-car charger included
- > IP67 water and dust resistant
- > Magnetic swivel mounting base with rubber feet
- > CE, FCC, RCM, RoHS, BC & PROP 65 approved and meets or exceeds standards required



10500073

### ARB Horizon Flash Light

The perfect companion for getting around at night on foot. Inbuilt battery indicator will ensure you don't get caught with flat batteries. The added ability for the light to charge phones is your perfect backup for blackouts at home or emergencies.

- > 4000mAh @ 5V power bank Li-Ion battery
- > Lumens - 60-600Lm
- > Digital smooth dimming control
- > Recessed dual function switch - 1 press battery indicator, 2 presses power on
- > Coloured battery indicator
- > Aluminium extruded body
- > 180m beam distance @ 1 Lux
- > 2-20hr Run time (high to low)
- > Type-C & type A braided cord - can be used as carry handle also
- > IP54 water and dust resistant
- > CE, FCC, RCM, RoHS, BC & PROP 65 approved and meets or exceeds standards required

10500080

### ARB Horizon Work Light

This work light has a wireless charger included and is compatible with any Qi certified wireless smart device & charged via type-C USB cable. The wireless charging base has rare earth magnets built in for auto locating the light to the correct charging area and also making it stick to all good metal surfaces. Included are touch tape straps to assist with holding the light in place for those bumpy roads.

- > 3200mAh @ 5V power bank Li-Ion battery
- > Large COB work/front light - 50-500Lm
- > Flash/top light - 150Lm
- > Digital smooth dimming control work light
- > Dual function switch - 1 press battery indicator, 2 presses power on
- > Flush mount dual control switch
- > Aluminium extruded body
- > Magnetic mounting and hooks
- > 2-20hr Run time (High to Low)
- > Three colour charging indicator
- > Type-C USB charging cord
- > IP54 water and dust resistant
- > Qi Certified wireless charging base - suitable for phones, earphones etc
- > Magnetic attachments for mounting and charging
- > Touch tape fasteners for additional securing
- > CE, FCC, RCM, RoHS, BC & PROP 65 approved and meets or exceeds standards required



## ARB Merchandise

217554

### ARB Flip-flops

Size - 7 to 8

Kick back and enjoy the warmer weather with a pair of ARB flip-flops. Featuring a topographical print for added interest and high grade polyethylene for superior comfort and durability. These flip-flops will keep you comfortable all day long.

217938

### ARB Camper Tumbler

Your drink companion, the Camper Tumbler, is just what you need on warm summer days out on the tracks. The insulated 304 stainless steel inner holds 300ml of your chosen beverage. The Camper Tumbler has bold ARB branding on the outer, a modern black finish with a flat base for stability.

217751 NEW

### ARB Topo Umbrella

This stylish golf-sized umbrella features ARB's iconic topo print, with alternative ARB branding and ADVENTURE AWAITS panels. Mounted on a sturdy pole, the black rubber handle features an ARB logo on the grip. Perfect for getting out and about on rainy days, this umbrella will easily provide shelter for a few bodies!

### ARB Edge Beanie

217974 NEW Black

217975 NEW Khaki

When the sun dips below the horizon and the mercury starts to drop, keep your noggin warm with an ARB Edge Beanie. Composed of 50% wool and 50% acrylic and a genuine Thinsulate™ lining, these beanies will keep your head nice and toasty. Featuring a fashionable mock suede embossed ARB badge.



Trasharoos



DA1591



DA1592



DA1593



The Trasharoo is a spare wheel mounted rubbish carry bag. It is the ultimate solution for keeping rubbish, along with their unwanted smells and leaks out of your vehicle. But it isn't just ideal for storing rubbish, Trasharoo is perfect for storing and carrying -

- > Wet suits & surfing gear
- > Muddy boots & clothes
- > Firewood & charcoal
- > Off-road recovery gear

DA1591	Black
DA1592	Beige
DA1593	Green

*The ultimate solution for keeping rubbish out of your vehicle*

Features

- > Fits a standard rubbish bag for ease of removing rubbish
- > Drawstring to keep rubbish secure
- > Will fit any tyre up to 40"
- > Designed to carry up to 22kg
- > Made from high quality 900 denier canvas
- > Water resistant interior coating for bad weather
- > All buckles and straps are double stitched
- > Built in flap zipper for storage of rubbish bags, gloves straps etc
- > 'X' strap design keeps the bag secure over thousands of miles

- > Drainage holes for any unexpected leaks
- > Slide over nylon covers to protect buckles from UV rays and dirt
- > Mesh elastic pockets and Molle straps for added storage
- > Can be used as an emergency back pack



ARB Track Pack

ARB4305

This versatile Track Pack provides storage for unwanted smelly rubbish and recyclables. Keep your rubbish sorted with unique internal dividers to create dual compartments, one for recyclables and one for general waste. The Track Pack can also be used to keep wet towels and clothes from a day at the beach or additional storage for dirty items or recovery gear. More information available online.

- > Large twin main compartments - overall 60 litres of space
- > Centre removable divider for organization of rubbish or gear
- > Top lid organiser for keys, rubbish bags or sunscreen
- > Twin side pockets with shackle holders
- > Full mesh base for easy clean out
- > Suits tyres up to 35"
- > Reflective strips for safety
- > Three point harness with anti-slouch strap
- > Security strap to deter thieves from stealing your bag
- > Includes built-in bottle opener



Expedition Boxes

Stay organised & keep your equipment protected with these durable, stackable storage units.

DA9993

Low Lid Expedition Box

External Dimensions  
510mm L x 400mm W x 230mm H  
Internal Dimensions  
450mm L x 340mm W x 205mm H

DA9994

High Lid Expedition Box

External Dimensions  
510mm L x 400mm W x 295mm H  
Internal Dimensions  
450mm L x 340mm W x 293.5mm H

Boxes shown stacked - supplied as singles



DA9993

DA9994

Manufactured from super tough black high density polyethylene plastic, the boxes lock tight with catches and feature a ribbed structure for additional strength. The boxes can be stacked on top of each other, with the base fitting firmly with the lid below reducing shifting of cargo in transit. Given the rigid structure of the boxes, ratchet straps can be used to hold boxes in position without damaging any of the contents. The storage capabilities of these boxes are limitless - from camping equipment, food supplies, recovery equipment, camera supplies and much more. Enabling you to keep your packing space organised and easy to access, whether that be in the boot or on the roof rack. The boxes are big enough to hold your supplies, whilst still being easy to lift in and out of your vehicle and are available in low and high lid options.

Features

- > Durable high density polyethylene plastic
- > Lock tight with catches
- > Integrated grab handles
- > Water resistant
- > Drainage holes
- > Stackable
- > Ribbed structure



DA9994



### ARB Stormproof Bags



The ARB Stormproof bags have a large roll-up (non-zip) opening - perfect access for packing and unpacking your contents. This unique roll-up opening with side tie down buckles creates a waterproof and dustproof environment, allowing you to store your cargo bag outside or transport it on your ARB roof rack. All ARB Stormproof bags now feature looped webbing straps on each side of the bag. The larger end loops accommodate tie down straps to retain your bag on the roof rack during transport with the other loop webbing straps suitable for attaching additional gear or hooks to the exterior of your ARB bag.

#### Features & Benefits

- > Polyester waterproof shell
- > PVC abrasion resistant base materials
- > Gear loops
- > Quick release buckles
- > Tie down loops, perfect for ratchet tie downs (fits ARB tie downs and others)
- > Stone coloured polyester
- > Strong double stitched webbing carry handle
- > Exterior mesh quick access pocket
- > Convenient shoulder strap included
- > Styled ARB logo

#### 10100350 Large

Capacity - 110 litres  
Size - 900 L x 400mm D Weight - 1kg

#### 10100330 Medium

Capacity - 70 litres  
Size - 680 L x 340mm D Weight - 0.80kg

#### 10100300 Small

Capacity - 50 litres  
Size - 590 L x 320mm D Weight - 0.74kg



10100350

### ARB Toiletries Bag

#### ARB4209

#### ARB Toiletries Bag

The ARB toiletries bag features ample space for two people and enough organisation compartments to keep all your items neatly in place on your next trip. Mesh pockets allow for good drainage, whilst the inclusion of a mirror ensures you look your best when next on the trails or heading off to the pub for dinner after a day out on the tracks.

- > PVC outer shell
- > Modern charcoal finish with red highlights
- > Up to 6 mesh storage pockets
- > Mirror
- > Storage loops
- > Hanging hook
- > Contents not included



### ARB Utility Case



#### ARB-4344

The ARB Utility Case makes finding your gear when you arrive at your destination nice and easy. It has a total of eighteen storage pockets that are perfect for storing cutlery, cooking utensils and other trail necessities with the added feature of a large removable pocket. The internal permanent pocket provides storage for plates. The inner compartment is built with heavy-duty mesh sections for storage of quick-to-reach items such as napkins, spices, or sauces. Housing all of your kitchen utensils is ten various sized smaller pockets with secure straps to keep your utensils from moving around. On the sides are slip pockets for small

chopping boards or other flat objects. Finally, a paper towel roll enables a quick clean-up and is secured with easy-slide steel buckles. Not only is this utility case great for your kitchen setup, it can also function as a trail tool kit. The utility case can be zipped up using the heavy-duty zipper providing easy access to your kit anytime.

#### Features & Benefits

- > 18 various size pockets for all your storage needs
- > Great for cooking utensils & cutlery, or tools
- > Handy removable pocket to store camping mugs or bulky items

- > Removable pocket has velcro/hook touch tape so it can be secured to drawer carpet
- > Webbing straps with metal hooks to allow suspension from the ARB Track Shelter or ARB Awning
- > Webbing strap to hold your paper towel roll
- > Rubber grip handle for carrying
- > Heavy-duty zipper to close neatly for stowage in an ARB Drawer system
- > Rubber ring pull to glide zipper open and closed - great if you're wearing gloves
- > Made from 600D heavy-duty poly Oxford material



### 4X4 ACCESSORIES

ARB products available in the UK only.

### ARB Cargo Organisers



10100371



10100378



10100373



10100379



#### ARB Cargo Organisers

Finding places to put objects of all shapes and sizes to maximize your space is a challenge and an art form. Having a place for everything and everything in its place removes the guesswork of finding your cargo when you pull up at your next destination. The solution is these ARB Cargo Organisers.

**Small ARB Cargo Organiser** - 400 W x 160 D x 180mm H

**10100371** With ID label holder

**10100377 NEW** With PVC lid

**Medium ARB Cargo Organiser** - 600 W x 200 D x 180mm H

**10100372** With ID label holder

**10100378 NEW** With PVC lid

**Large ARB Cargo Organiser** - 400 W x 400 D x 180mm H

**10100373** With ID label holder

**10100379 NEW** With PVC lid

#### ARB Cargo Dividers

**10100374** 4 pack Suitable for medium Cargo organiser

**10100375** 2 pack Suitable for large Cargo organiser

#### Features

- > 600D PU coated heavy-duty Oxford nylon
- > Durable webbing handles making it easy to move or carry
- > Zippered top to keep contents secure and clean
- > ID label holders or clear PVC top to help identify contents quickly
- > Removable dividers that are movable and removable - for large & medium sizes
- > Additional dividers sold separately
- > Folds flat when not in use - easy to store & maximize space
- > Matches colour and styling of the ARB Cargo product range
- > Easy clean interior with PU coated nylon



## ARB Tool Roll Bag

10100388 **NEW**

Don't leave home without your valuable tools! This handy ARB Tool Roll Bag allows you to easily secure your most valuable tools whilst on the road or in the garage. Featuring four removable tool pouches and a removable wheel guard cover, the bag will help you keep your tools organised and secure.

**Features & Benefits**

- > Easy-clean PVC shell
- > Cordura lining that rolls up tight for storage
- > 4 removable tool pouches
- > Space for a set of spanners
- > Removable wheel guard cover with magnets
- > Excludes tools





#### NAV021 Navigator Outdoor Storage Buddy

- > Made to attach to the Navigator Awning Buddy
- > Can also be connected to the Navigator Kitchen Buddy
- > Corner eyelets to fasten to camping ridge poles (cable ties not included)
- > Buckles with webbing to fasten to camping ridge poles
- > 3 x handy mesh pockets
- > Large zip storage compartment featuring 10 sectioned shelves
- > Versatile storage solutions
- > Organise your shoes/kids toys/bulky and light pantry items
- > Attach the Navigator Outdoor Buddy for more storage space
- > On the reverse side the Outdoor Storage Buddy features another 7 x large sleeve pockets
- > 700 x 500mm



#### NAV022 Navigator Hose Sullage Buddy

- > Storage of sullage hose made easy
- > Full length twin zipper for complete access
- > Zipped trap door on lid to make pack up easy
- > Side rubber mesh panels to allow moisture to escape
- > Front rubber handle complete with side grab handles
- > Rubber base with heavy-duty feet
- > 2 x access points at back of bag
- > 350 x 500 x 150mm



#### NAV023 Navigator Utility Buddy

- > Storage for all your caravan utilities made easy
- > Full length twin zipper for complete access
- > Interchangeable woven badges to identify contents
- > Side rubber mesh panels to allow moisture to escape
- > Front rubber handle complete with side grab handles
- > Rubber base with heavy duty feet
- > Multiple uses:
- > Store fresh water hose and fittings
- > Store your power leads and accessories
- > Store guy ropes and pegs
- > Removable internal zip pocket to store additional accessories
- > 2 x access points to back of bag
- > 300 x 480 x 150mm - main utility buddy
- > 230 x 100mm - removable pocket
- \*Hose, fittings, power leads, guy ropes and pegs not included

#### NAV027 Navigator Collapsible Bin Buddy

- > Large heavy gauge zipper opening with clip in buckles to keep birds and flies out and trap the smells in
- > Heavy-duty sealed lining for moisture protection, making it easy to clean
- > Grab handles on each side
- > Large zip pocket at the front to store spare bin liners
- > 4 x metal 'D' rings to keep in place on windy days
- > Large access zipper at the back for frame assembly
- > Folds completely flat when not in use
- > Always use a rubbish bin liner with your Bin Buddy
- > Fits 82 litre bin bags
- > 400 x 400 x 600mm



#### NAV018 Navigator Collapsible Laundry Buddy

- > Large heavy gauge zipper featuring rubber mesh venting
- > Heavy-duty sealed lining for moisture protection and easy cleaning
- > Removable shoulder strap designed to carry dirty washing to the laundry, complete with grab handles on each side
- > Large front zip pocket to store shoulder strap and coins for the laundry
- > Large access zipper at the back for frame assembly
- > Folds completely flat when not in use
- > 300 x 450 x 700mm



#### NAV036 Navigator Fire Wood Buddy

- > Robust double layer fabric
- > PVC base with internal semi-rigid membrane
- > Strong webbing carry handles with extra large padded handle
- > Zip pocket for storing gloves
- > Folds flat for easy storage
- > Weight rating - 32kg
- > 400 x 580mm
- \*Wood not included



#### NAV032 Navigator Mini-Bin Buddy

- > Hard moulded lid with zipper to keep in odours
- > Heavy duty sealed lining for moisture protection, making it easy to clean
- > Grab handles on each side
- > Zip pocket at the front to store spare bin liners
- > Access zipper at the back for frame assembly
- > Folds completely flat when not in use
- > Fits 32 litre bin bags
- > 250 x 290 x 400mm



#### NAV040 Navigator Compact Shovel Buddy With Bag

- > Handle has two adjustable lengths - 820 & 650mm - perfect to get into tight spots around wheels
- > Made from lightweight anodized aluminium
- > Three parts disconnect for compact storage
- > Comes with quality zipped soft bag for ease of storage and protection - when stored in bag: 440 x 60 x 230mm
- > Stores easily into 4WD's, caravans & campers
- > Great for around the campsite to minor beach recovery in sand

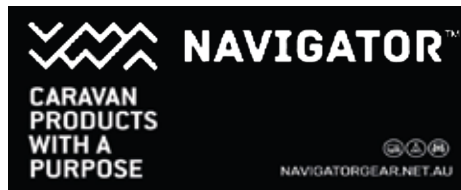

Navigator products available in the UK only.

*Navigator is an outdoor caravan, camping & adventure brand that provides accessories with a purpose for the modern-day nomad to assist in getting the best experience with as little stress as possible.*



#### Navigator Awning Buddy

##### NAV1002

Single Pack

##### NAV2002

Twin Pack

- > Made to fit into sail track on caravan awning and most 4WD awnings
- > 7mm spline, will fit most caravan awning barrels
- > Eyelet allows use on camper trailer and 4WD awnings
- > Magnets to hold bottle opener
- > Reflector tape at base for safety
- > Includes storage bag
- > Fitted with two female buckles to allow use with Navigator Kitchen Buddy & Navigator Outdoor Storage Buddy
- > 50 x 2100mm

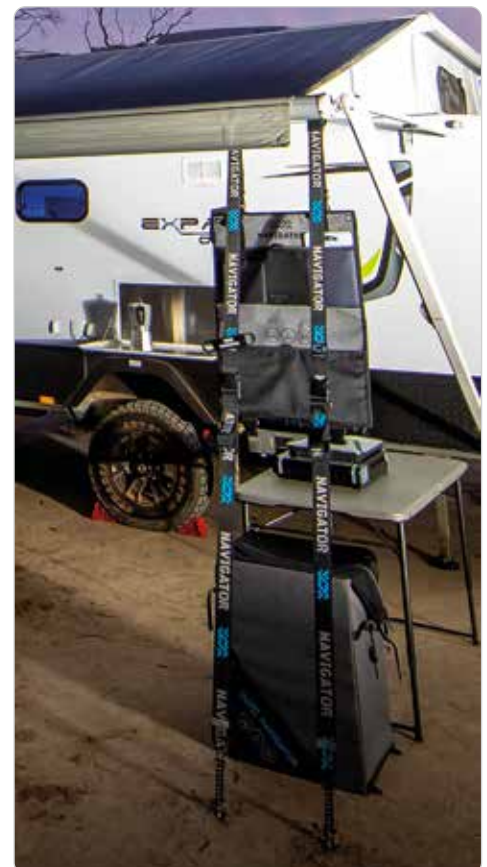



Navigator Camping Gear

Navigator Gear - In Your Vehicle

NAV024

NAV024

Build It - Seat Buddy

- > Fashionable & practical storage organiser for your vehicle
- > iPad flat strap located at the top
- > 3 x pockets across the centre - 2 x open, 1 x zippered
- > Huge zipper across the bottom with soft protective lining
- > 3 x rows of webbing loops across the top and also on the base pocket to allow maximum storage options to suit
- > Installs quickly and easily with head rest strap and elasticated base hooks
- > Folds flat in half to pack away conveniently when empty
- > Versatile storage solutions

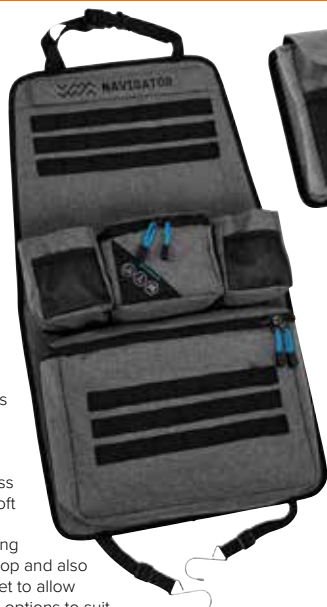

NAV025

NAV025

Build It - Pocket Buddy

- > Can only be used in conjunction with the Build It Seat Buddy
- > Features 3 x bellow pockets, 2 with velcro flaps & 1 with zip closure
- > Bellow pockets include additional sleeve pockets, making it a total of 6 pockets
- > 4 x military style press studded webbing straps across the back allowing quick application or removal



NAV026

NAV026

Build It - Kids Pocket Buddy

- > Can only be used in conjunction with the Build It Seat Buddy
- > Generous insulated drink bottle holder with bungee cord
- > Built in neoprene pencil case with zipper
- > Three sleeve pockets to store colouring books and the 'Babysitter' aka iPad
- > Four military style press studded webbing straps across the back allowing quick application or removal



NAV009

Navigator Quick Fix Seat Buddy

- > Quick and easy organiser for children
- > Clear PVC pocket for iPad storage (can store iPad up to 12")
- > Pocket designed to store iPad complete with its protective case
- > PVC pocket is fingertip friendly enabling you to use the iPad whilst it is stored
- > 2 x large mesh and sleeve pockets to store colouring books and pencils
- > Simple set and pack-up using head rest strap and base elasticated hook
- > Folds into carry case for your child to take with them for security when leaving the vehicle
- > Main compartment - 280 x 460mm



NAV007

Navigator Visor Buddy

- > Installs quick and easy onto most vehicle sun visors
- > 1 x mesh pocket for storage of business cards/note pad/swipe cards
- > Heavy-duty 'criss cross' elastic bands for organized storage of multiple items e.g. pens, sunglasses, remote controls for gates/garage doors
- > 350 x 170mm

\*Pens, etc not included



NAV013

Navigator Carabiner Keyring

- > Total length - 145mm
- > Carabiner - 65 x 35mm
- > Keyring - 95 x 25mm

**Note** - Not to be used for rock climbing. Single.

NAV008

Navigator Dashboard Buddy

- > Dashboard solution to store tissues, mobile, pens, sunglasses & receipts etc
- > Genuine Velcro brand adhesive
- > 240 x 170mm

\*Glasses, tissues etc not included



Navigator products available in the UK only.



Navigator is an outdoor caravan, camping & adventure label that provides accessories and tools for the modern-day nomad to assist in getting the best possible experience with as little stress as possible. Navigator uses premium quality materials tested by their team of avid outdoor enthusiasts together with the experience of manufacturing products in the 4WD industry for over 15 years.



# CAMPING

## Campsite Accessories

### Navigator Camping Gear

#### Navigator Gear - In Your Campsite Kitchen



#### NAV020

##### Navigator Kitchen Buddy

- > Made to attach to the Navigator Awning Buddy
- > Can also be connected to the Navigator Outdoor Storage Buddy
- > Corner eyelets to fasten to camping ridge poles (cable ties not included)
- > Buckles with webbing to fasten to camping ridge poles
- > Magnet to hold Navigator bottle opener
- > 8 x sleeve pockets for organising cooking utensils
- > 4 x mesh pockets to store cooking spices
- > Large lower storage pocket with zip closure
- > 2 x large handy sleeve pockets
- > Folds in half for convenient storage
- > 700 x 50mm
- \* Cutlery and spices not included

#### NAV034

##### Navigator Collapsible Wine Glass Buddy

- > Use in caravan, 4WD or general camping to protect precious glassware
- > Hard top with zip closure
- > Removable dividers to fold flat
- > Folds completely flat for storage
- > Accommodates 4 wine glasses - 330ml
- > 175 x 175 x 210mm
- \*Glasses not included



#### NAV016

##### Navigator Pantry Jar Buddy

- > Pack of 3
- > Padded pantry protection
- > Protects glass containing food & liquid
- > Quick and easy to apply
- > Conveniently stores flat when not in use
- > Reversible Velcro to allow each buddy to be attached together
- > Fully adjustable to fit most standard jars
- > Create any shape to fill voids in the pantry
- > 100% neoprene
- \*Jars not included



#### NAV029

##### Navigator Pantry Wine Buddy

- > Pack of 3
- > Padded pantry protection
- > Protects large glass bottles
- > Quick and easy to apply
- > Conveniently stores flat when not in use
- > Reversible Velcro to allow each buddy to be attached together.
- > Fully adjustable to fit most standard jars
- > Create any shape to fill voids in the pantry
- > 100% neoprene
- \*Wine not included



#### NAV014

##### Navigator Microwave Dish\* Buddy

- > Clever and simple - slide the microwave dish into the Microwave Dish Buddy, zip close, place back into the microwave for protection through all your journeys both on and off road
- > Features padded layers to protect microwave dish
- > Stylish zipper with carry handle
- > Fits most microwave plates (up to 320mm diameter)
- > Remove microwave dish from the Dish Buddy before use
- > 330 x 330mm
- \*Microwave dish not included

Navigator products available in the UK only.

### ARB Fire Pit

#### 10500200

##### ARB Fire Pit

This is a seriously sturdy and versatile fire pit that will be just as useful at home entertaining guests in the backyard, as it will be at your favourite campsite. A fire pit for camping has to be portable and while the design of the ARB Fire Pit might not scream "revolution", they have added some key elements that make a good design great. The base structure of the fire pit is a five-piece assembly, slotting together without requiring any tools. To ensure longevity and improved heat retention, all pieces are cut from a solid three-millimetre sheet of REDCOR® steel. A base plate ensures the coals and associated heat remain in the pit, while the top edges are folded with integrated tabs to secure the included cooking grill. It is also designed to suit your own sourced cast iron BBQ plates and rotisserie. The included cooking grill utilises half of the fire pit's top opening and features both a grill and hotplate section. The cooking grill is made from 4mm mild steel and can be seasoned with cooking oil and a quality fire. The whole unit collapses down and fits neatly into the supplied Australian made canvas carry bag.

##### Weathered Look

REDCOR® is a new class of steel that won't rust, but will weather to a nice patina. This look and finish are the actual desired look and finish of this material and is not a warranty concern. The steel was specifically picked to do this and some customers may have concern around this, but this is the finish and look we aimed for. The patina will actually provide additional protection to the fire pit and keep in good use for years to come.



##### Key Features

- > Keeps fire contained and controlled
- > Included mild steel cooking plate
  - Can be used to cook directly on once seasoned
  - Perfect for boiling camp kettles or keeping cooked food warm
  - Mounting tabs for 320 x 480mm cast iron plates (not included)
- > REDCOR® steel by BlueScope - high heat handling and only rusts/weathers to a nice patina finish
- > Flat folding design and packs into strong 10oz canvas bag
- > Rotisserie mounting holes (rotisserie not included)
- > 4x Included bottle openers

##### Technical Specifications

- > 3mm REDCOR® steel by BlueScope
- > Cooking grill - 4mm mild steel
- > Carry bag - 10oz canvas bag with strap
- > Weight - 18kg
- > Packed dimensions (LxWxH) - 600 x 300 x 35mm
- > Open dimensions (LxWxH) - 600 x 496mm x 300mm
- > Cooking grill dimensions (LxW) - 580 x 272mm

**3195294SP NEW**  
Replacement BBQ grill plate for ARB  
Fire Pit 10500200





Great Gift Ideas  
For All Landy Lovers



### Haynes Books & Manuals

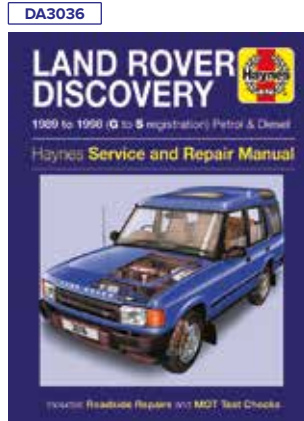
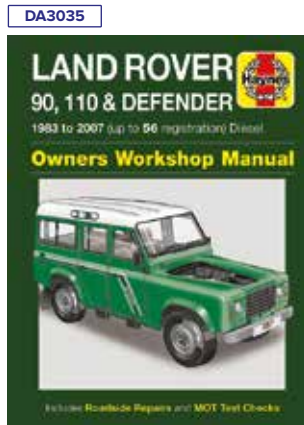
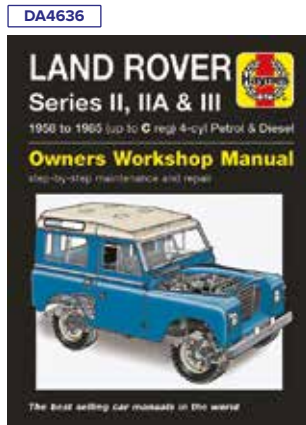

Let Haynes Show You How

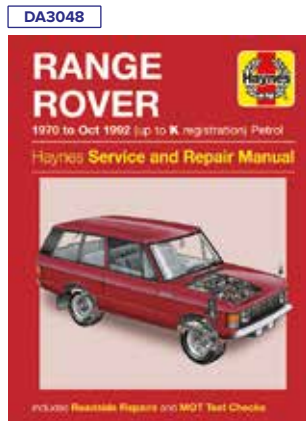
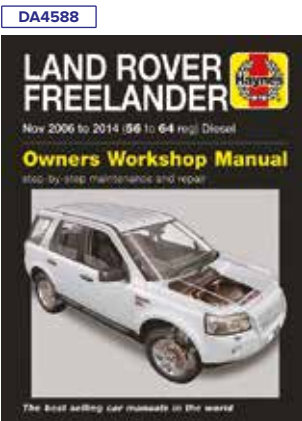
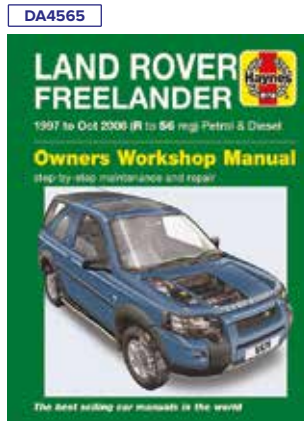
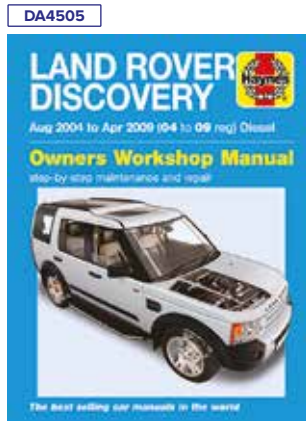
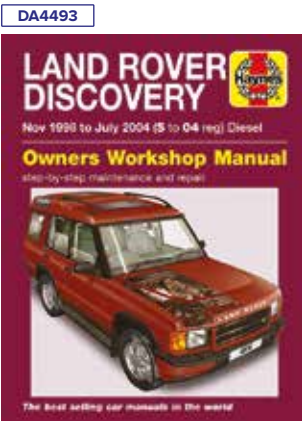

<b>DA3041</b>	Restoration Manual	Series 1, 2 & 3
<b>DA4636</b>	Owners Workshop Manual	Series 2, 2A & 3 - 1958 - 1985 (up to C reg) Petrol & Diesel
<b>DA3035</b>	Owners Workshop Manual	90, 110 & Defender - 1983 - 2007 (up to 56 reg) - Diesel
<b>DA3206</b>	Owners Workshop Manual	Defender - 2007 to 2016 (56 to 16 reg) - Diesel
<b>DA3036</b>	Haynes Service & Repair Manual	Discovery 1 - 1989 - 1998 (G to S reg) - Petrol & Diesel
<b>DA4493</b>	Owners Workshop Manual	Discovery 2 - Nov 1998 - July 2004 (S to O4 reg) - Diesel
<b>DA4505</b>	Owners Workshop Manual	Discovery 3 - Aug 2004 - April 2009 (O4 to O9 reg) - Diesel
<b>DA4565</b>	Owners Workshop Manual	Freelander 1 - 1997 - Oct 2006 (R to 56 reg) - Petrol & Diesel
		<b>Note</b> - Does not cover models with 2.5 V6 petrol engine
<b>DA4588</b>	Owners Workshop Manual	Freelander 2 - Nov 2006 to 2014 (56 to 64 reg) - Diesel
<b>DA3048</b>	Haynes Service & Repair Manual	Range Rover Classic - 1970 - Oct 1992 (up to K reg) - Petrol

### Catalogues, Manuals & More...

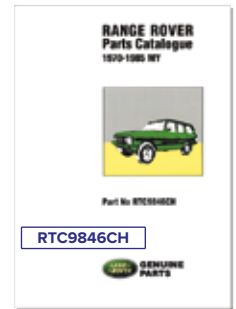

- Parts Catalogues**
- RTC9840CC** Series 2A - Bonneted Control
  - RTC9842CE** 2A, 3 & 109 V8 - Optional Equipment
  - RTC9841CE** Series 3
  - RTC9837C** Series 3 - Lightweight
  - RTC9863CE** One Ten
  - STC92021CC** Covering vehicles up to August 1986
  - RTC9947CF** Defender 90/110/130
  - RTC9947CF** Covering 1987 - 2006
  - RTC9947CF** Discovery 1
  - RTC9947CF** Covering 1989 - 1998 - 2.0 Mpi/3.5/3.9 V8 petrol & 200Tdi/300Tdi diesel engines
  - STC9049CA** Discovery 2 - Covering 1999 - 2003
  - RTC9846CH** Range Rover Classic - 1970 - 1985
  - RTC9970CE** Range Rover P38
  - RTC9970CE** Covering 1995 - 2001 - 4.0/4.6 petrol & BMW 2.5 diesel engines

- Handbooks**
- DA3162** Defender 90/110/130 - Covering 1991 - February 1994
  - DA3162** 2.5/3.5 V8 petrol & 2.5/200Tdi diesel engines
  - LRL0087ENG** Defender 90/110/130 - Covering March 1994 - 1998
  - LRL0087ENG** 2.5/3.5 V8 petrol & 2.5/300Tdi diesel engines
  - DA3161** Discovery 2 - Covering 1999 - 2004
  - DA1625** 80" - 1948-53/86" & 107" - 1954-55/88" & 109" - 1956-58
  - DA1625** Large format well illustrated handbook which includes details on driving control including general information to assist in operating the vehicle to the best advantage plus maintenance & service items.
  - 608180** Military Series 3 Lightweight illustrated user manual.
  - 608180** Covering Series 3 truck, Utility, 1/2 Ton with 12 & 24 volt electrical equipment. This manual was originally published by The Ministry of Defence Code Number 22228. 178 pages.

- Workshop Manuals**
- RTC9839C** Series 1 - petrol & diesel workshop
  - DA3157W** Defender Td5 workshop manual
  - DA3157E** Defender Td5 electrical manual
  - DA3147** Freelander 1 - 2001 - 2003 onwards
  - DA3147** Includes V6 petrol engines
  - DA3148** Range Rover L322 - 2002 - 2005\*
  - DA3148** Workshop manual
  - DA3149** Range Rover L322 - 2002 - 2005\*
  - DA3149** Electrical manual - Includes electrical library and electrical circuit diagrams

\*Covering BMW 4.4ltr petrol V8 engines & BMW 3.0L diesel engines

- Other Publications**
- DA3156** Winch In Safety - A5 hand book by Land Rover with pictures throughout.
  - LRL0178ENGLR** Replacement service portfolio





Landy Books

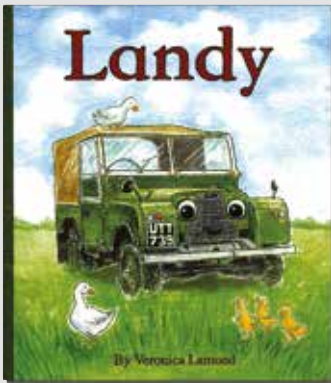

**LANDY**  
 "Landy has been left abandoned for many years until, one day, Jack finds him..."

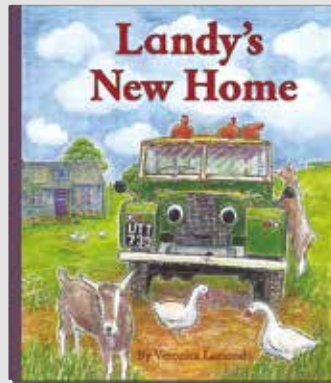

**LANDY NEW HOME**  
 "Jack and Landy are busy setting up their small holding but Landy feels left out. When Fender arrives, Landy realises he hasn't been forgotten after all..."

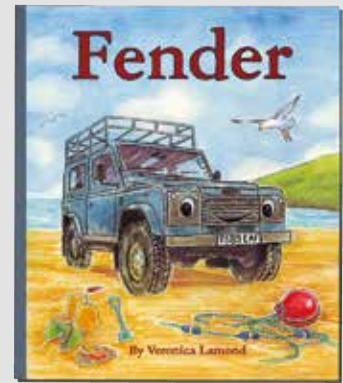

**FENDER**  
 "Scamp races Fender down the track - they have lots of things to do and lots of friends to meet..."

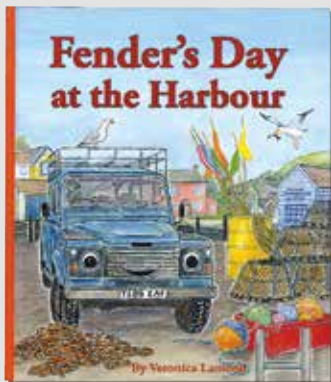

**FENDER HARBOUR**  
 "Fender watched the fishermen fixing their boats and the swing shovel at work. Meanwhile, Dan and Jack weren't having much luck..."

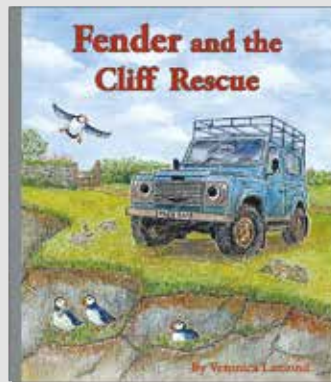

**FENDER RESCUE**  
 "Dan and Fender spend a day working up on the cliff top. Then Jack calls for help and they drive off to the rescue..."

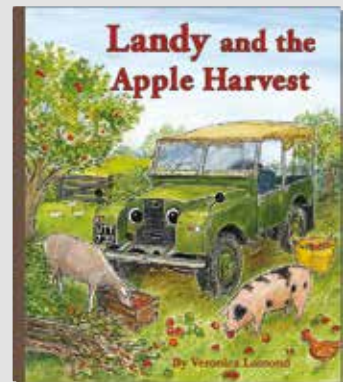

**LANDY HARVEST**  
 "After a very windy night, Jack decides it's time to gather up all the fallen apples. Landy helps him bring the harvest home..."

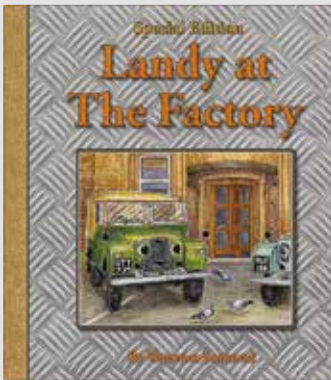

**LANDY FACTORY**  
 "Inside the envelope, he found a letter from the Land Rover factory. "How exciting, Landy," said Jack. "We've been invited to visit the factory to celebrate your 60th birthday!"..."

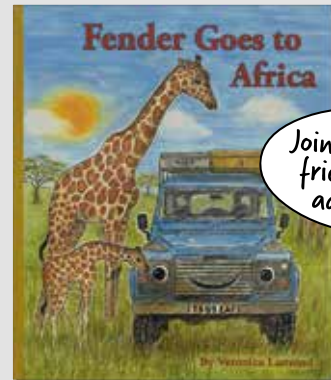

**FENDER AFRICA**  
 "Fender and Dan are on their long trip through Africa, from Cairo to Cape Town. Come and join them on their exciting adventure..."

*These charming hardback books, which are beautifully written and illustrated by Veronica Lamond, are an excellent gift idea for any Land Rover fan - whatever their age!*

Join me and my friends on our adventures!



Books & MagBooks



DA2909



DA3202

DA3188B



**DA2909**  
**JUE 477** - The remarkable history and restoration of the world's first production Land-Rover  
 The world's first production Land-Rover (history and restoration). The remarkable history and restoration of the world's first production Land-Rover. A dedicated team of experts, led by chief restorer, Julian Shoolheifer set about restoring the vehicle while retaining as much of its original DNA as was physically, and safely, possible and crucially, making sure that this remarkable vehicle's history and past life was still worn with pride. By Martin Port. 280 x 240mm. Hardback - 128 pages.

**DA3202**  
**Range Rover - The First Fifty Prototypes**  
 YVBs and NXCs - the story of the early Range Rovers. Today, the Range Rover is a legend. The original design lasted in production for more than a quarter of a century. It is those very first Range Rovers which are the subject of this book. Its aim is to record the story of the earliest vehicles before it becomes lost in the mists of legend and distorted by commercial misrepresentation. With 160 illustrations and 160 pages. More information about this book is available online at [www.britpart.com](http://www.britpart.com)

**DA3188B**  
**A Celebration of the Best 4X4XFar**  
 Issue 2. From the publishers of Land Rover Monthly a 228 page celebration of the Defender including vehicles through the ages, rebuilds & repairs and buyers guides.



### Land Rover Original Technical Publications



The days of hunting around auto-jumbles for grubby and damaged workshop manuals, parts lists and owner manuals are over! At least they are if you own one of the many classic Land Rover and Range Rover models covered in the range of Original Technical Publications compilations. Carefully reproduced from the extensive historical archives in England and in the USA, we are pleased to give you access to the original Land Rover publications needed to run and maintain your classic Land Rover, including parts catalogues (most models), service manuals and owner's literature. Original parts books, workshop manuals and handbooks for Land Rovers and Range Rovers have always been greatly sought after, and rightly so: nothing compares to a Land Rover workshop manual compiled by the car's manufacturer. Now owners and enthusiasts have the opportunity to effortlessly collect all the original publications for their favourite Land Rover or Range Rover, on one handy and cost-effective title. These publications are the original publications used by the Land Rover parts department, service garages and sales departments when these cars were still in production and being serviced. Each section provides detailed information on major systems, diagnostics, troubleshooting, overhaul, as well as the removal and installation of major components. Compiled in an easy to understand format, these publications contain step by step processes designed for the mechanic and the enthusiast. In addition most manuals are filled with detailed illustrations and sometimes photographs and diagrams to help with identification of components and proper assembly. What's more, you can find information and links to Land Rover Cars, Land Rover Heritage, Land Rover Clubs and Original Technical Publications. Check out the latest picture galleries, video and media archives - even download classic Land Rover and Range Rover wallpaper to personalize your computer, tablet or phone.

#### Online eBook\*

The online eBook wallet includes additional text and instructions as well as the web address required to access the interface and content from a personal computer (Mac OSX or Windows) as well as tablets or handheld devices (Mac iOS, Windows or Android). The eBook product provides each registered customer with a single license for one device. In other words, if a customer registers their personal computer they would be able to access BOTH the USB (if applicable) as well as access the information online on that device. If a customer registers their handheld device (iPad, tablet or hybrid) they would ONLY have access on that device once the viewer is installed and the license is authenticated.

\*Note: The 'online access' option does not apply to the Portable USB. See opposite.

#### Product Features

- > Printable (Windows only) - print only the pages you need
- > Viewable & zoomable
- > Searchable - search the entire section in seconds
- > Bookmarked - manuals are bookmarked to quickly locate sections

#### System Requirements

- > User must have administration rights to allow installation.
- > PC Windows 10 or later, Safeguard Windows PDC viewer
- > Mac OS X 10.8 (64 bit) or above, Safeguard OS X PDC viewer\*
- > iOS 9.1 and above Safeguard Mac iOS viewer
- > Android 5.0 and above Safeguard Android viewer
- > Printing not available for Apple OSX or iOS applications unless running a Windows emulation software.

*Both products are Handy & Easy to use!*

<b>LTP3001</b>	Series models - 1948 - 1985. Includes military Land Rover 90, 110 & 127
<b>LTP3003</b>	Defender 90, 110 & 130 - 1983 - 2011. Includes military
<b>LTP3004</b>	Discovery 1 - 1989 - 1999
<b>LTP3006</b>	Discovery 2 - 1999 - 2004
<b>LTP3016</b>	Discovery 3 - 2004 - 2008
<b>LTP3017</b>	Discovery 4 - 2009 - 2012
<b>LTP3007</b>	Freelander 1 & Freelander 2 - 1998 - 2011
<b>LTP3002</b>	Range Rover Classic - 1970 - 1995
<b>LTP3005</b>	Range Rover P38 - 1994 - 2001
<b>LTP3008</b>	Range Rover L322 - 2002 - 2010
<b>LTP3015</b>	Range Rover Sport - 2005 - 2009

#### Portable USB

USB for Windows PCs. Installation of viewer on host computer is all that is required as the user license is bound to the USB. Internet access is not required for use or activation unless the user is prompted to check for a viewer update for the particular device where the USB is being used. Each (Portable USB ebook) product is a portable software product, no registration or activation is required. DRM license is bound to the supplied USB enabling product access only to that particular.

#### Product Features

- > Printable - print only the pages you need
- > Viewable & zoomable
- > Searchable - search the entire section in seconds
- > Bookmarked - manuals are bookmarked to quickly locate sections
- > Internet not required
- > Portable between Windows computers
- > Secure documents are instantly accessible just like ordinary files

#### System Requirements

- > PC - Windows 10 or later. USB port, Safeguard Windows PDC viewer. Must have administration rights to allow installation.
- > USB port

See [www.britpart.com/otp](http://www.britpart.com/otp) for much more in depth information about what is included with each product. Far too much to list here!

<b>LTP3001USB</b>	Series models - 1948 - 1985. Includes military Land Rover 90, 110 & 127
<b>LTP3003USB</b>	Defender 90, 110 & 130 - 1983 - 2011. Includes military
<b>LTP3004USB</b>	Discovery 1 - 1989 - 1999
<b>LTP3006USB</b>	Discovery 2 - 1999 - 2004
<b>LTP3016USB</b>	Discovery 3 - 2004 - 2008
<b>LTP3017USB</b>	Discovery 4 - 2009 - 2012
<b>LTP3007USB</b>	Freelander 1 & Freelander 2 - 1998 - 2011
<b>LTP3002USB</b>	Range Rover Classic - 1970 - 1995
<b>LTP3005USB</b>	Range Rover P38 - 1994 - 2001
<b>LTP3008USB</b>	Range Rover L322 - 2002 - 2010
<b>LTP3015USB</b>	Range Rover Sport - 2005 - 2009

#### Which OTP Product is best for me?

The Original Technical Publications are now available in two formats - Portable USB Online eBook.

#### Windows PC

User has 2 choices - Portable USB or Online eBook. Windows 10 or a later version. Requirements - USB port & Safeguard Windows PDC viewer. **Note** - Portable USB recommended as it can be easily moved from computer to computer - internet not required.

#### Apple OSX

Online eBook access via the online access URL. Mac OSX 10.8 (64 bit) & above. Requirements - Internet access & Safeguard OSX PDC viewer.

#### Apple iOS

Online eBook via the online access URL. iOS 9.1 & above. Requirements - Safeguard Mac iOS viewer. **Note** - Online eBook is recommended as it is everything you need when using from your iPad - works best with internet

#### Android

Online eBook via the online access via the online access URL - works best with internet. Android 5.0 or later. Requirements - Safeguard Android viewer.

**Notes** - Printing not available for Apple OSX or iOS applications unless running a Windows emulation software. The Portable USB option is for use on Windows PCs only. (This option is considered to be multi-license because it can be moved between Windows PCs simply by installing the PDC viewer). The Online eBook is for use on all Operating Systems except Linux. (This option is supplied with a single license for one device.)

#### LTP3010

##### OTP Land Rover Master Collection

The ultimate Land Rover Technical Publication Collection covering models from 1948 to 2012. A must for any Land Rover specialist, garage, restoration facility or aficionado.

##### Models Covered

Series - 1948 to 1985/Land Rover 90, 110, 127 & Defender 90, 110 & 130 - 1983 to 2011/Discovery 1 - 1989 to 1999  
Discovery 2 - 1999 to 2004/Discovery 3 - 2005 to 2009/Discovery 4 - 2009 to 2012/Freelander 1 - 1998 to 2011  
Range Rover Classic - 1970 to 1995/Range Rover P38 - 1994 to 2001/Range Rover L322 - 2002 to 2010  
Range Rover Sport - 2005 to 2010

*A must for any Land Rover aficionado!*



LTP3010

#### Contents

**Parts Publications** - Parts catalogues, parts index (where available, approximately 1948 to 2004).

**Service Publications** - Service manuals, service procedures, system description and operation, circuit diagrams, electrical libraries.

**Technical Information & Tools** - Special service tools, testbook user manual, T4 diagnostic system user manual.

**PDI and Maintenance** - Workshop manual - pre-delivery inspection, pre-delivery inspection sheet, oil service, annual inspection.

**Owners Literature** - Owners handbook, additional handbooks:- In-car entertainment/audio/TV and navigation system/audio and navigation system/in-car telephone.

**Supplementary Information** - Sales brochures, accessory fitting instructions, photo gallery, downloads and various links.





**XS PowerPack**  
MULTI-FUNCTION JUMP STARTER



- DA1239** UK mains plug
  - DA1239EU** EU mains plug
  - DA1256** Replacement jump leads for DA1239(EU). For 600A model - check pack label
  - DA1255** Replacement 12V adaptor
- Not suitable for DA1239 & DA1239EU purchased before 18/06/2018

**Technical Specifications**

Battery volume: 18,000mAh  
 Starting current: 350A  
 Size: 230 x 87 x 27mm  
 Weight: 615g

Output:  
 5V = 2.1A - (smart phone/tablet fast charge)  
 12V = 10A  
 19V = 3.5A (laptops/notebooks)

Input: 14V = 1A  
 Peak current: 700A

- > Small and lightweight high capacity nano lithium polymer portable power pack with the latest battery technology
- > Supports fast charging with low self-discharge cycle
- > Charging cycles can reach more than 1,000 times
- > Supports 12V jump starts as well as back up charging or many brands of mobile phones, laptops, tablets, portable refrigerators etc
- > Supports 3 different types of charging modes
- > Built in redundant electronic control safety protection for jump starter over-charging and over-discharging

The XS & XD PowerPacks are handy to keep with you on your travels to ensure you never run out of 'juice'!



**XD PowerPack**  
MULTI-FUNCTION JUMP STARTER

- DA1238** UK mains plug

**Technical Specifications**

Battery volume: 9,000mAh  
 Starting current: 200A  
 Size: 131 x 75 x 25mm  
 Weight: 300g

Output:  
 5V = 2A (smart phone/tablet fast charge)  
 14V = 1A

Input:  
 Peak current: 400A

- > Small and lightweight portable power pack with the latest nano lithium battery technology
- > High capacity, high power special battery
- > Supports fast charging with low self-discharge cycle
- > Charging cycles can reach more than 1,000 times
- > Supports 12V jump starts as well as back up charging for many brands of mobile phones, tablets etc



See them both in action at [www.britpart.com/powerpack](http://www.britpart.com/powerpack)



DA1239 kit contents



DA1238 kit contents



Photo by Angel Fernandez

Dog Ramp



**DA1631**

This handy dog ramp is perfect for dogs who have difficulty jumping into the back of your Land Rover. With an anti-slip coating the ramp is quick and safe to use even in wet conditions. The ramp is perfect for aging & injured dogs as well as puppies and smaller dogs who can't reach!

**No more hurting your back lifting up your dog!**



**Features**

- > Telescopic lightweight design for quick and easy storage
- > Rubber feet to hold ramp in position
- > Catch to hold together when stored
- > Anti-slip coating

**Specifications**

- > Maximum weight capacity - 90kg
- > Weight - 7kg
- > Length compressed - 1,000mm
- > Length extended - 1,850mm
- > Width at widest point - 450mm
- > Deck width - 390mm

Make life easier for you & Rover!



See it in action at [www.britpart.com/DA1631](http://www.britpart.com/DA1631)



### Skytag

#### DA9012

##### How It Works

- > Pinpoint GPS tracking
- > Worldwide coverage
- > 24/7 service
- > Tamper alerts
- > Intelligent movement alerts
- > Direct police access and liaison
- > Simple to install and transferable
- > Internal backup battery
- > 5 year warranty



##### About Skytag

Skytag are now the largest independent stolen vehicle recovery company in the UK, providing state of the art location equipment to recover your property quickly and efficiently. With an outstanding recovery record and an 11 minute fastest record, they are proud to offer a service second to none. With unique features like monthly operation checks and direct police access to live location information.

The Skytag device is a very small covert unit designed to be hidden in a vehicle, self installation enhances the covert nature of the product as everyone will put it somewhere different, making it virtually impossible to find, this also reduces costs and makes the unit easily transferable from vehicle to vehicle with no charges.

The device is smaller than a computer mouse and contains a GPS chip that can pin-point its location on the planet to within 5 metres. The device also contains a module that communicates this position to us via the GPRS data network. So we know exactly where your vehicle is in the event of a theft.

Our unit comes with the peace of mind of full worldwide cover and is IP65 waterproof. The device has an inbuilt backup battery that lasts 3 days should the vehicle battery be disconnected. It also alerts us when the battery has been disconnected; we can even tell when the vehicle battery is running low, ensuring continuous operation.

##### Skytag Packages

###### Standard Tracking

£7.99/month - payments to Skytag  
Initial 3 months service included. Standard service includes battery disconnect alerts, tracker battery low power alert. Monthly health check and email notification. Worldwide coverage. 24 hour crime line with police liaison to recover your vehicle.

###### Active Monitoring

£11.99/month - payments to Skytag  
Initial 3 months service included. Standard Tracking service plus active movement alerts.

'LeisureSafe' is designed for leisure vehicles which are used 2-3 times a week, 'LeisureSafe' is fully automatic with no requirement to remember to turn on or off. A bespoke zone is created where the vehicle is normally stored. If the vehicle moves out of this zone during the protected hours, alerts are sent direct to your mobile phone, your landline, text and email.

'NightSafe' is designed for everyday use vehicles where you need protection during the vulnerable night hours. Using a zone similar to 'LeisureSafe' the system alerts leaving the 'Safe Zone' during the armed period.

###### Live Tracking

£13.99/month - payments to Skytag  
Live Tracking has all the features of the active monitoring service with the addition of user designed zones, speed alerts and the ability to log in from any internet enabled device and see the vehicle updated every 5 minutes with the ignition wired installation, or every 20 mins with standard fitting. 'Liveview' service includes unlimited email alerts and 10 direct telephone alerts per week.

### Tamper Proof Nuts & Bolts



Ensure your precious accessories remain firmly on your Land Rover by using a set of these stainless steel tamper proof nuts and bolts. Ideal for securing your winch and front bumper. Each set contains either 4 nuts or bolts and 1 key.

**DA7330** M6 nut set & key

**DA7331** M8 nut set & key

**DA7332** M10 nut set & key

**DA7333** M10 x 110 bolt set & key

**DA7334** M10 x 35 bolt set & key

### Security Marking Kit

#### DA8533

The International Security Register (ISR) system has proved successful in deterring and detecting theft and fraud for over 30 years. It works on the principle that if a vehicle's windows and parts are marked using robust techniques and details are recorded on a secure database - supported by a 24/7 verification service - criminals stealing the vehicle will run a real risk of being caught and prosecuted. Each mark applied to a vehicle will contain a unique 8-digit code, the ISR logo and [www.isrcodecheck.com](http://www.isrcodecheck.com)



*Reducing the risk of your Land Rover being stolen or cloned.*

##### Pack Components

- > Full instructions on marking and registering a Land Rover are in the security marking kit.
- > 8 vinyl stencils, fluid and brush for marking windows.
- > 2 warning decals.
- > 2 sets of 6 UV self-etch labels for application to painted metal body panels.
- > 2 sets of 7 ultra-destruct labels with UV fluid and applicator for identifying plastic parts.
- > A set of three Britpart branded security tags for increasing the chance of items that are so often mislaid, being returned to the owner.
- > A Britpart branded ISR customer contact card.

##### Registration of Vehicle and Owner Data on the ISR

The vehicle owner - or the stockist - would complete the registration process online via the Britpart registration page at [www.TheISR.org](http://www.TheISR.org) then select "All Vehicles" then "Vehicles" followed by "Britpart Registration Form" entering the unique code together with the vehicle make, model, colour, VIN and VRM together with the owners name and contact details. If an email address is supplied, an automated acknowledgement of registration would be sent. The code for the security tags would be automatically recorded.

More details of the kit can be found at [www.britpart.com/security](http://www.britpart.com/security)

### X-Defend Pedal Lock



thick steel claw grabs the brake pedal shaft and ratchets in tight against it. It can be locked in a couple of seconds! To unlock turn the key which releases the pedal and fold flat on the floor. The Pedal Lock is supplied in tough, corrosion proof 304 stainless steel and uses formed hinges with a 6mm stainless pin. It is supplied with an anti-drill, British made Lowe & Fletcher RPT Lock.

**Note** - This does NOT fit Series/Defender - 2007 onwards. As not all Defenders are the same and build tolerances are at best acceptable it may be necessary to either relocate the bonnet pull bracket (you can drill out the spot welds and re-attach with pop rivets) or better still replace with the later Td5 type bonnet pull (FSC000050PMA). We have discovered that because Land Rover had no set place to fit the early type bracket it sometimes fouls the pedal lock.

##### Defender

- up to Td5 without air-con

**DA6601** Right hand drive

**DA6602** Left hand drive

The X-Defend Pedal Lock prevents the clutch, brake and throttle pedal from being operated, making a vehicle almost impossible to drive! Unlike other pedal locks, this

remains bolted to the floor of the vehicle. When not in use, it folds flat on the floor and seat box, forming the floor of the cab. In this position it can be covered with your usual floor mat. This means you don't have to store a 20kg lump of metal which could be lethal if it hit you in the event of an accident or while off-roading. It also means that locking is incredibly quick. Just release the catch which holds it against the seat box and lock into position. A 10mm

### X-Column



#### DA9013

One thing that is common to virtually all stolen Land Rovers is that the column steering lock has been broken. It is normally broken by removing the lock barrel as this is surprisingly quick - the vehicle can then often be started with a screwdriver. This neat solution is a sleeve for the lock barrel assembly machined out of steel. It is strong enough to prevent the barrel being removed or the end broken off.

### Nothing to lock or unlock

The best thing about this solution is it's completely passive - i.e. nothing to lock or unlock. It stays permanently fitted to the vehicle providing 24 hour protection and deterrent value. The column lock will fit all Defenders LHD or RHD - up to 2014, including Puma/Tdci. One exception is that some ex-military vehicles do not have a steering lock. While the column lock will fit - it serves no purpose as there is nothing for it to protect.

### Locking Fuel Cap



#### DA1227

Defender - from XA159807

Discovery 2

Locking fuel cap

Supplied with 2 keys

*Add some extra protection to your fuel.*





Quick Release Steering Wheel Bosses & Locks

Optimill Steering Wheel Bosses

- DA8883** Slimline boss with quick release 48 splines
- DA8882** Slimline boss with quick release 36 splines

Optimill slimline boss fits directly to your steering column, without the need for multiple bosses to be used. Manufactured to the highest standard, hard anodised to prevent wear and designed to give an extra level of security to your vehicle.

**DA8884**

Optimill Quick Release Security Lock

Produced as a swivel locking cover to fit over an Optimill Quick Release Boss (36 or 48 spline).

**DA8884DOCK**

Optimill Quick Release Security Lock Docking Station

Manufactured to screw into your cubby box or where you choose to store your Optimill quick release swivel lock.



**OPTIMILL**

More details available online



Photo by Bogdan Muscalu

Radiator Muffs



**DA4025BLACK**



**DA2160BLACK**



**DA2161BLACK**



**DA2157**



**DA2163**



**DA2162**



**DA2153**

Series 2

Series 2A - Early Models

- DA4025BLACK** Black edging
- DA4025BLUE** Blue edging
- DA4025GREEN** Green edging

Series 2A - Late Models

Series 3

- DA2160BLACK** Black edging
- DA2160BLUE** Blue edging
- DA2160GREEN** Green edging

Defender

- DA2161BLACK** Black edging
- DA2161BLUE** Blue edging
- DA2161GREEN** Green edging

Discovery 1

- Black edging
- DA2153**
- Discovery 1 - up to LA
- DA2157**
- Discovery 1 - MA onwards

Discovery 2

- DA2163**
- Discovery 2 - square headlights
- DA2162**
- Discovery 2 - round headlights

**Note** - The radiator muffs are black with either black, blue, brown or green coloured edging.

*Control the flow of air into your radiator with a quality British made radiator muff!*



# MISCELLANEOUS

## Wiper Blades



**PRC1330SS**  
Stainless steel Series  
Front  
Single



**DKC500010PMDLR**  
Heavy-duty  
Discovery 2  
Front  
Pair



**VUB500900**  
Heavy-duty  
Freelander 1  
Front  
Pair



**Note** - These heavy-duty winter wiper blades should not be used at high speeds, they are a winter blade designed for harsh conditions.

**LR079891F**

Defender - Front & Rear  
Range Rover Classic  
1992 - 1994 - Rear  
Single

**Bosch OE**

**Specialty AeroTwin Flat**

Bosch continues its innovation and expands its wiper blade portfolio by providing wiper blades with unique, special adapters that are hard to find in the market for your vehicle.

- > Blended dual rubber compound with graphite coating for long life.
- > Asymmetrical wind spoiler for better windshield contact.
- > Patented beam technology for a uniform wipe.

### Starting Handle

**218508**

Starting handle for Series vehicles

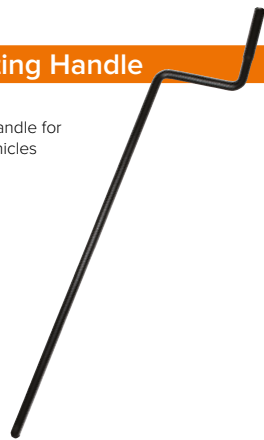

Photo by Larry Beckler

## Dash Cameras



**DA5202 NEW**

Have a third eye on the road for those unexpected moments! Drive with a security expert by your side with the Ring Smart Dash Camera and Ring Connect. Save, download and share your dash cam footage easily in one place, making it easier to look back on your journeys, and if the worst was to occur, gather crucial evidence in one place.

A full HD 1080p resolution dash cam with 32GB storage capacity. A 120° field of view and 30fps create a high quality, full HD image to see more of what is happening outside your vehicle. Includes an interior trim installation/removal tool and a quick and easy to use magnetic mount for a stronger, more secure fitting. The dark colours and compact size help keep the camera discreet in the car, avoiding any distractions.

- > Full HD 1080p 30fps recording for clear, high recording quality
- > 120° field of view to capture a wide view of the road
- > Ring Connect and wi-fi enabled - works with Ring Connect App
- > Easy installation and removal with a magnetic mount and trim tool included
- > G-sensor to automatically save files in the event of a collision
- > 32GB memory capacity with micro SD card
- > 2" screen
- > Auto start/stop - prevents vehicle battery from being drained
- > Trim installation/removal tool included
- > Dimensions - 45 x 76 x 34mm (HxWxD)
- > Weight - 188g
- > Voltage - 12V - 24V DC
- > Wattage - 5
- > Amps Output - 0.35
- > Batteries included - Rechargeable lithium-ion



**VPLKV0134LR NEW**

Front & Rear Camera  
Defender - 2020 onwards / Discovery Sport / Discovery 5  
Range Rover Evoque - 2019 onwards / Range Rover Velar  
Range Rover Sport - 2014 - 2022  
Range Rover Sport - 2023 onwards  
Range Rover - 2013 onwards  
Range Rover Sport - 2014 onwards  
Drive with peace of mind that events and incidents will be captured with the Land Rover dash cam. Designed to seamlessly integrate with your Land Rovers cabin and electrical system.

With low power consumption for extended use and full HD front and rear video camera, the camera makes it easy to look back in journeys, and if the worst occurs, to gather crucial evidence.

- > Removeable front camera with fixed viewing angle
- > Fixed rear camera with adjustable viewing angle
- > G-sensors trigger recording in the event of an accident or heavy braking
- > An integrated radar system\* to enable recording when your parked vehicle is approached
- > Record additional events with a manual record option
- > Onboard GPS allows used to optionally add speed and location data to the linked video files to create a detailed record of each event
- > Includes 32GB SD card
- > Recordings can be accessed and controlled by optional Apple of Android apps, or via a web browser

**Note** - Not compatible with windscreen sun shield. To preserve the 12V battery life it may be necessary to disable this feature on some vehicles. \*Only available on certain vehicles



Photo by Greg Hilton

T-Shirts



UNION JACK FLAG



BECAUSE THE EARTH...

Union Jack Flag

- Grey t-shirt
- DA8051 Small
- DA8052 Medium
- DA8053 Large
- DA8054 X-Large
- DA8055 XX-Large



Because the Earth...

- Grey t-shirt
- DA8056 Small
- DA8057 Medium
- DA8058 Large
- DA8059 X-Large
- DA8060 XX-Large



WHEELS



HEADLIGHTS

Wheels

- Grey t-shirt
- DA8061 Small
- DA8062 Medium
- DA8063 Large
- DA8064 X-Large
- DA8065 XX-Large



Headlights

- Grey t-shirt
- DA8066 Small
- DA8067 Medium
- DA8068 Large
- DA8069 X-Large
- DA8070 XX-Large



STEERING WHEELS

Exclusive to...

**BRITPART**

- > 100% cotton
- > Reactive dyed
- > Crew neck
- > Taped shoulder to shoulder
- > Twin needle stitching on neck & shoulders
- > Enzyme washed for extra soft hand-feel and reduced shrinkage

A great gift idea!

For more images of the t-shirt designs go to [www.britpart.com/tshirt](http://www.britpart.com/tshirt)

Steering Wheels

- Beige t-shirt
- DA8071 Small
- DA8072 Medium
- DA8073 Large
- DA8074 X-Large
- DA8075 XX-Large



Photo by Craig Hogg



Photo by Richard Rushton

Haynes Internal Combustion Engines



DA4817



DA4310

Build a working model of an engine.

DA4817

Build a fully functional, motorised model of a V8 petrol engine. Features sound recorded from a real V8 and illuminating spark plugs. The kit contains nearly 300 pieces and all that you need to assemble the model. It is supplied with a Haynes style manual giving you clear step-by-step instructions as well as interesting information about real V8 engines.

DA4310

Build a realistic working model of a combustion engine. Includes light and sound features, light up spark plugs, moving pistons, valve gear, fan belt and 'Haynes Manual'. Finished model size - 180 H x 270 W x 140mm D



### Remote Control Defender Model



#### DA1626

From Tamiya R/C - this is a superbly detailed 1/10 scale remote control model assembly kit of an early version of the Defender 90. **The model's bodywork needs painting - ideal for having the chance to match your own Defender's colour!**

- > 457 L x 200 W x 214mm H and Wheelbase - 242mm
- > The Defender 90 form is accurately captured by the polycarbonate body, with slide moulding used for great detail such as rear panel surfaces.
- > Includes separately moulded parts for grille, side mirrors, light cases and tyre cover.
- > Compatible with 5mm diameter LEDs (white) x 2 for headlights and 5mm diameter LEDs x 6 for the rear.
- > Matt plated wheels are paired with realistic tyres featuring authentic tread pattern.
- > Highly reliable CC-01 chassis features a full-time 4WD system and front double wishbone, rear 4-link rigid suspension equipped with 4 CVA oil dampers.
- > An expansive range of option parts is available to customise the CC-01 chassis. The CC-01 chassis is Tamiya's ultimate platform for mounting precise scale renditions of off road chassis. With built in wheel arches, sealed front and rear gear boxes with precision engineered differentials and shaft driven 4WD via universal joints, it replicates all the rugged realism of the Defender 90 - as such it is the ultimate platform to carry this iconic body.



*Superbly detailed  
1/10 scale remote  
control model  
assembly kit*



#### DA1627

Remote Control System

- > Operating voltage transmitter 4.8 - 6V
- > 2.4GHz system
- > Two continuously variable, fully proportional channels
- > Servo reverse for both channels (change of running direction)
- > Trimming function for acceleration and steering
- > Power supply of the BEC receiver possible via driving battery with 4.8 - 7.2V
- > Connector system for Futaba and Graupner JR
- > Charging socket (positive pole inside)
- > Battery charge level display by means of LED
- > 4 Channel receiver
- > Transmitter batteries
- > Battery pack NiMH 7.2V/2100 mAh
- > Plug charge (Output 9V/300 mA)



**Note** - The remote control is not supplied with the model and needs to be purchased separately.



### Sit On Defenders



- DA1517 White
- DA1518 Orange
- DA1520 Red

For smaller Land Rover fans we have these! Fully licensed by Land Rover, these Defender 6V electric toys are suitable for children aged 3 to 7. These toys are equipped with working LED lights and realistic engine sounds. MP3 connectivity means your little ones can listen to their favourite music as they drive around. The cars can be controlled by either the child driving or by a parent with the remote control handset. 2.4GHz radio control ensures each car has its own frequency so can't be controlled by anything else - ideal if you have two Defenders in the same location.

Maximum load capacity - 20kg  
Size - 780 x 410 x 490mm / Weight - 10kg

#### Features

- > 6V 4.5AH battery
- > Power indicator display
- > Working LED headlights
- > Seat belt for added safety
- > Realistic engine sounds
- > MP3 connection
- > Forward and reverse gears
- > 2.4GHz radio control
- > Easy to assemble



Photo by Rachel Travers





Photo by Domanov Evgenii

Castrol Classic Oils Merchandise

**DA6270** Castrol Tin Mug - Drink your tea in a nostalgic way with this large tin mug  
**Castrol Pouring Jugs** - Use either to decorate your workshop or study or to accurately measure lubricant quantities shown in imperial measures in vehicle handbooks  
**DA6271** Half pint  
**DA6272** Pint  
**DA6273** Quart (two pints)  
**DA6274** Baseball Cap - Smart green cap with embroidered Castrol logo. One-size fits all  
**DA6275** Window Service Sticker  
 Never forget to change your oil with this self-cling window sticker with Castrol logo on one side and Change Due boxes on the other. 3" diameter.



Ride On Suitcases



Make travelling with kids fun with the Range Rover Sport SVR convertible kid's ride on and suitcase! This beautifully crafted officially licensed scale model of a real Range Rover can be used as a pull along suitcase but the really clever bit is that it also converts quickly and easily into a fun kids' ride on toy. Ideal for parents travelling with kids as it will keep kids amused while travelling - perfect for planes, trains or cars and for playing on when you get to your destination too. It is a must have accessory for all little Range Rover fans! It is big enough to hold everything you need in your hand luggage including toys, clothes and games but also not too bulky to be pulled along using the pull-out handle. It is quick and easy to convert it into a kids' ride on car toy with the clever fold up handle - kids can push themselves around plus it makes a great seat for kids to sit on while in queues for check in too!

Suitable for age 2+ years.

Max recommended user weight: 23kg.  
 Product size: 548 L x 296 W x 223mm D

*Converts quickly and easily into a fun kids' ride*



- DA1836** Red
- DA1835** White
- DA1837** Blue



Land Rover Merchandise

LGGF397MXA

Land Rover Defender Model

The Land Rover Defender model, developed in partnership between LEGO® & Land Rover, showcases the refined, modern Defender. The high authentic model features original design rims, ground gripping tyres in addition to many other realistic features and functions. The functional opening doors give access to the interior with working steering wheel and replica dashboard. The model includes the transmission system with 2 levers for engaging high or low gear ratios, and a selector for changing gear. It the most sophisticated LEGO® cylinder engine so far.

Inside the model you will find forward facing folding rear seats, this allows you to see the 4-speed sequential gearbox. With features such as the in-line 6-cylinder engine with moving pistons, working all wheel drive with 3 differentials, independent suspension and working winch make this model stand out from the rest! The rear-mounted spare wheel allows the tail door to be opened.

The quality finish of the model includes removable roof rack with storage box, pannier, ladder and traction mats. The model provides a hands on immersive building experience, perfect for any Land Rover enthusiast!

Features

- > Highly authentic model
- > Land Rover emblems
- > Ground gripping tyres
- > Removable roof rack with storage box
- > Opening doors, bonnet and tail door
- > Detailed cabin
- > Modern olive green, grey and black colour scheme

Functions

- > 4-speed sequential gearbox
- > All Wheel Drive with 3 differentials
- > Independent suspension on both axes
- > 6-cylinder engine
- > Working winch
- > 2 levers for engaging high/low gear ratios and selector for changing gear

Details

- > Includes a collection of authentic stickers
- > Includes over 2,500 pieces
- > A LEGO® Technic™ set
- > 220 H x 420 L x 200mm W







**LRDCA3EVOG**  
Range Rover Evoque - 3 Door  
Fuji White  
1:43 scale die-cast model



**LRDCA5EVOG**  
Range Rover Evoque - 5 Door  
Mauritius Blue  
1:43 scale die-cast model



**LRDCA494**  
Range Rover Sport  
- 2014 onwards  
Chile Red  
1:43 scale die-cast model



Photo by John Walton



**Defender First Edition 1:43 Scale Models**

- LGDC921GNY NEW** Defender 90 - Pangea Green
- LGDC922SLY NEW** Defender 110 with Explorer Pro accessory pack in Indus Silver

Collectors' edition replicas of the new Land Rover Defender. High quality die cast model made from zinc alloy with closed parts. This range of scale models captures all their rugged, iconic style. Made from high quality materials. Rich with detail and infused with a legendary history. Suitable for children 14+ years old.



**LRCORPMUG14**  
Logo Mug  
Land Rover logo mug



**LRCEAHUEG**  
Stoneware Mug  
Green stoneware mug with raised embossed HUE 166



**LGMG474NVA**  
Stoneware Mug  
Branded stoneware mug with a robust construction and a matte navy finish. Features Land Rover wordmark and geometric graphic detail.



**LGKR515BKA**  
Metal Keyring  
Land Rover oval logo keyring with black infill.



**LFMG363WTA**  
Bone China Mug  
White fine bone china mug with Heritage logo to one side and Series print to the other



**LEKR323SLA**  
Defender 3D Keyring  
3D satin nickel plated metal Defender on a keyring and chain. Designed to replicate the famous Land Rover Defender this keyring matches fun with practicality.



**LGKR468IVA**  
Loop Keyring  
Ivory  
A hard-wearing loop keyring with split ring made from fine leather. Features debossed Land Rover wordmark and perforation detailing, with bamboo colour stitching.



**LGKR468NVA**  
Loop Keyring  
Navy  
A hard-wearing loop keyring with split ring made from fine leather. Features debossed Land Rover wordmark and perforation detailing, with bamboo colour stitching.



**LHTT619NVA**  
**Defender Multi-Tool**  
 Black steel credit card sized multi-tool crafted into the classic Defender silhouette. Featuring 11 practical tools. Including: bottle opener and tyre gauge.

**LJTY009BNA**  
**Above & Beyond Teddy Bear**  
 The perfect companion for little adventures. This soft-touch Adventure Bear. Wears a removable replica Land Rover x Musto jacket and removable waterproof style backpack with working zipper for extra fun. With hand-stitched facial features and a Land Rover wordmark on the paw.



**LFTY420GNA**  
**Transformable Defender**  
**1:14 Remote Control Scale Model**  
 A 1:14th remote control version of the Defender, capable of transforming and driving with the push of a button. With a full direction remote, resembling a Transformer style, that is ideal for kids, adults and collectors alike.

- > Full function radio control; one key transform, forward, reverse, turn left, turn right, display with speaker and light.
- > Not suitable for children under 8 years old.
- > Defender model car: requires 4 x AA batteries (not included).
- > Remote control: required 3 x AAA batteries (not included).



**LKTT063BKA NEW**  
**Above & Beyond 11-in-1 Hammer Multi-Tool**  
 Advanced multi-tool with matte-black hardware. Fabricated in durable anodised metal. Includes 11 utility tools, including hammer, pliers, glass breaker, blade, saw, steak knife and wire cutters. Finished with white Land Rover logo. Comes with a handy carry pouch.



**LGGF391BKA**  
**Above & Beyond Pocket Multi-Tool**  
 Pocket-sized and packed with tools. This all-in-one utility keyring is made from stainless steel and reinforced with a black aluminium cover. Small, sleek, but seriously useful. Tools include pliers, bottle opener built into cutter, Phillips screwdriver & knife with safety lock. Carabiner attaches to bags. Supplied with branded carry pouch. Dimensions - Closed length: 80mm & Fully extended length: 120mm. Weight: 74g (excluding pouch) & 95g (including pouch)

Ideal **birthday**  
 or **Christmas** gifts for any  
**Land Rover** enthusiast -  
 whatever their age!



**LJTT015BKA NEW**  
**Above & Beyond Torch**  
 An adventure essential. Five function water-resistant torch made from a machined aluminium. Includes emergency setting that blinks "SOS" in morse code. Equipped with zoom function and a powerful light output of 800 lumens. 4 hour run time. IPX4 water-proof designation. LED voltage 4.5V. Requires 3 x AAA batteries (not included).



**MJUM030BKA NEW**  
 Exit your Land Rover and stay dry in the rain. Made by Musto. With its reverse canopy this umbrella's innovative design makes for easy opening when getting in or out of a car and other tight spaces. It folds dry, and stops water being transferred to other items. Featuring a laser perforated windproof design that stops it turning inside out.



**LJFM008MXA**  
**Heritage Socks**  
 Set of three Land Rover Heritage Socks featuring classic Defender, Discovery 1 and Range Rover Classic appliqué in original model colours. Woven with classic flat-linked toe seams for extra comfort. Presented in eco-conscious recyclable craft packaging that fits easily through a letterbox. Men's 7-11 UK size.



**LGNB517NVA NEW**  
**Land Rover Branded A5 Notebook.**  
 Featuring embossed Land Rover wordmark with lined page



**LJUM123NVA NEW**  
**Golf Umbrella**  
 Performance manual opening golf umbrella. Dark blue with Land Rover text.





**DA1219**  
1:18 Scale Model  
Range Rover Evoque - 2-door Red  
This very detailed die-cast Evoque replica is not a toy and is not suitable for children under 14. The model is 245 L x 120 W x 95mm H. Opening doors, boot and even the side mirrors fold on this superb scaled replica which is a must for all collectors and enthusiasts.



**1:24 Scale Models**  
**DA1633**  
Defender 1:24 scale Grey Blue



**DA3403 NEW**  
Defender 1:24 scale Light Green



**DA1413**  
Jaguar F-Pace 1:24 scale Red

### 1:76 Scale Models

<b>DA3478 NEW</b>	Series 1 88"	Bronze Green
<b>DA3511 NEW</b>	Series 2 Canvas Top	Bronze Green
<b>DA3513 NEW</b>	Series 3 Hard Top	Bronze Green
<b>DA3509 NEW</b>	Military Defender	Green
<b>DA1324 NEW</b>	Defender 90	Tamer Blue
<b>DA3510 NEW</b>	Defender 90 Autobiography	Corris Grey
<b>DA3375 NEW</b>	Defender 90	Pangea Green
<b>DA3444 NEW</b>	Defender 90	Tasman Blue
<b>DA3376 NEW</b>	Defender 110 X	Godwana Stone
<b>DA3377 NEW</b>	Defender 110	Indus Silver
<b>DA3446 NEW</b>	Defender 110	Eiger Grey
<b>DA3447 NEW</b>	Defender 110	Santorini Black

<b>DA1624</b>	Discovery 3	Cairns Blue
<b>DA1516</b>	Discovery 5	Santorini Black
<b>DA3374 NEW</b>	Discovery 5	Namib Orange
<b>DA3449 NEW</b>	Range Rover Classic	Lincoln Green
<b>DA3450 NEW</b>	Range Rover Classic	Masai Red
<b>DA1323</b>	Range Rover Evoque	Baltic Blue
<b>DA1318</b>	Range Rover Evoque	Firenze Red
<b>DA3370 NEW</b>	Discovery 4	Firenze Red
<b>DA3371 NEW</b>	Range Rover Sport SVR	Indus Silver
<b>DA3372 NEW</b>	Range Rover Sport SVR	Fuji White
<b>DA3373 NEW</b>	Range Rover Velar SE	Fuji White



**DA1335** 1:76 scale Defender Heritage set - 3 piece set



**DA3445 NEW** 1:76 scale Defender 90/110/110X - 3 piece set



**DA3478**



**DA3511**



**DA3513**



**DA3509**



**DA1324**



**DA3510**



**DA3375**



**DA3444**



**DA3376**



**DA3377**



**DA3446**



**DA3447**



**DA1624**



**DA1516**



**DA3374**



**DA3449**



**DA3450**



**DA1323**



**DA1318**



**DA3370**



**DA3371**



**DA3372**



**DA3373**



**DA8002**  
Keyring - Karabiner Style



**DA8025**  
Ice Scraper



**DA8017**  
Drawstring Bag



Note - Single. Photo shows both sides



**DA8004**  
Ceramic Mug

**DA8015**  
Stainless Steel Travel Mug



**DA8037**  
Pocket LED Torch



**DA1511**  
Defender Exhaust Mug

Manufactured using a metal spinning technique from sheets of 304 stainless steel then spun into 3" diameter. The exposed lip gets outward rolled to replicate a Defender exhaust. The handle, also of 304 grade (8mm) round bar, pressed into shape. This resembles an exhaust hanger. Each Britpart branded mug is finished by hand polishing. This weighty mug (300g and 420ml capacity) is perfect for use in any workshop.



**DA8038**  
Notebook - Hardback  
148 x 210mm



**DA8099**  
Notepad - Softback  
148 x 210mm



**DA8111**  
Luxury Pen Set  
Britpart branded carbon fibre effect ball pen & rollerball



Supplied in gift box.

**DA8114 NEW**  
Embroidered Keyring  
130 x 25mm



**DA8112**  
Insulated Water Bottle  
500ml double walled, stainless steel, drinks bottle with a matching coloured lid and silicone carry handle. Keeps hot and cold drinks at the perfect temperature. BPA & PVC free. Britpart branded.



**DA8113**  
A5 Notebook Wallet  
Made from Bio-D, a quality imitation leather material that has a soft touch and is vegan friendly. The notebook jacket contains a lined white notebook which is made from 100% recycled paper. Debossed with Britpart logo and supplied with Britpart pen.

**DA8109G NEW**  
Jerry Can Hip Flask  
Stainless steel painted blue  
142ml capacity

**DA1229**  
Stress Toy  
Defender



**DA8016**  
Teddy Bear  
5" high



**DA8024**  
Ruler  
300mm



**DA8014**  
USB Flash Drive  
Die cast metal Defender with working headlights. 16Gb. Simple, portable, personal storage with a high reading & writing speed.

**DA8101**  
Golf Umbrella



Twin rib 750mm golf umbrella

**DA8043**  
Credit Card Wallet



Two internal pockets

**DA8082**  
Panda Bear  
5" high



**DA8042**  
Air Fresheners  
Pack of 5  
Cool wave scent



Ball Point Pens

**DA8003**

Pack of 10

**DA8003X**

Pack of 100



**DA8110 NEW**  
Defender Shaped Wooden Keyring  
64 x 34 x 6mm  
Qty 1



Photo by Sara Bouma



# MISCELLANEOUS

## Britpart Stockist Merchandise



T-SHIRT



POLO SHIRT



SWEAT SHIRT



LOGO ON BACK OF POLO & SWEATSHIRT



FLEECE



FLEECE BODY WARMER



DA8013



DA8021

T-Shirts	
DA8029	Medium
DA8028	Large
DA8020	X-Large
DA8050	XX-Large
DA8100	XXX-Large
Hats	
DA8013	Ski hat
DA8021	Baseball cap

Polo Shirts	
DA8045	Small
DA8005	Medium
DA8006	Large
DA8007	X-Large
DA8008	XX-Large
DA8080	XXX-Large

Sweatshirts	
DA8046	Small
DA8009	Medium
DA8010	Large
DA8011	X-Large
DA8012	XX-Large
DA8081	XXX-Large

Fleeces	
DA8047	Small
DA8040	Medium
DA8041	Large
DA8018	X-Large
DA8019	XX-Large

Fleece Body Warmers	
DA8077	Small
DA8078	Medium
DA8079	Large
DA8049	X-Large

Body Warmers	
DA3460 NEW	X-Large
DA3460M NEW	Medium
DA3460L NEW	Large
DA3460 NEW	X-Large
DA3460XXL NEW	XX-Large

Please ask the sales team for details...

Windproof with mobile pocket on chest. Elasticated hip detail with longer back panel. Lower pockets with velcro fastened flaps & hand warmers. Deep elasticated armholes with weather protectors. Full front zip with studded storm flap.



**DEFENDER STICKER**  
Defender Stickers  
100 x 60mm  
Qty 25



**TRAYBACK STICKER**  
Trayback Stickers  
100 x 60mm  
Qty 25



**DA8023PACK**  
Keyrings  
Qty 25

## BRITPART

The quality parts for Land Rovers



**DA8114X NEW**  
Embroidered Keyrings  
130 x 25mm  
Qty 25



**DA8110 NEW**  
Defender Shaped Wooden Keyring  
64 x 34 x 6mm  
Qty 1



**CARRIER BAG**  
Carrier Bags  
380 x 470mm  
Qty 50



**DA8042PACK**  
Air Fresheners  
Cool wave scent  
100 x 65mm  
Qty 25



**EXTERIOR STICKER**  
High tack vinyl gloss stickers  
300 x 90mm  
Qty 25

**INTERIOR STICKER**  
Self-cling window stickers  
220 x 70mm  
Qty 25

**LOGOBOARD**  
Britpart logo on 3mm foamex board  
900 x 300mm  
Qty 1

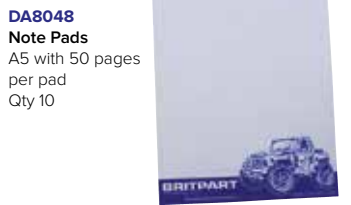

**DA8048**  
Note Pads  
A5 with 50 pages per pad  
Qty 10



**DA8039**  
Sticky Pads  
Qty 10



**POSTER SET**  
Poster Set

A2 poster set of 8  
380 x 470mm



**DA1229PACK**  
Stress Toy  
Defender  
Qty 25



**DA8016PACK**  
Teddy Bear  
5" high  
Qty 25



Accessory Catalogue  
**CATALOGUE**  
Qty 5

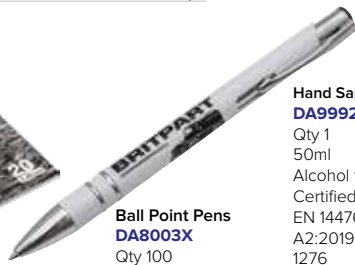

Ball Point Pens  
**DA8003X**  
Qty 100

Hand Sanitiser Gel  
**DA9992**  
Qty 1  
50ml  
Alcohol free  
Certified to BS EN 14476:2013 + A2:2019 7 BS EN 1276



**LUCASCAT**  
Lucas  
Classic 4x4  
Catalogue  
Qty 25

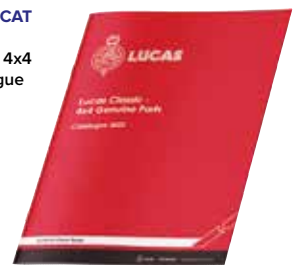

Part Number	Page Number	Part Number	Page Number	Part Number	Page Number	Part Number	Page Number	Part Number	Page Number
07160LUCAS	221	1780440	40	330337	236	511036	204	813408	316
0740113	60	1780450	40	330422	115	514148LUCAS	219	813409	316
0830001	61	1780460	40	330422GREY	115	514150LUCAS	219	814102	316
08500021	101	1780470	40	330426	236	517469SS	158	814406	315
09023	204	1780480	39	330427	236	517588G	180	814407	315
10100010	60	1780490	39	330553	113	517589G	180	814408	316
10100111	125	1780500	39	330950	236	519740LUCAS	218	814412	316
10100300	322	1780510	39	330999	113	519742LUCAS	218	815100	318
10100330	322	1780511	39	33110AG	113	519743LUCAS	218	815118	318
10100350	322	1780512	39	33110BL	113	519744LUCAS	218	815206	316
10100371	322	1780515	39	33110SA	113	532268	196	815227	316
10100372	322	1780520	39	331113AG	113	532268G	196	815230	316
10100373	322	1780600	39	33113SA	113	535173G	180	815248	316
10100374	322	1780610	40	331259AG	113	537179	58	815252	316
10100375	322	17900010	38	331259SA	113	545010	202	815253	316
10100376	314	17900020	38	331260AG	113	546440	204	815254	316
10100377	322	17900050	38	331260SA	113	548205PY	170	815255	316
10100378	322	17900060	38	33137IAG	113	548205PY-YELLOW	170	8510072H	207
10100379	322	180222SP	119	331401	93	549473X	263	90519864LUCAS	220
10100385	318	180223SP	119	331481	93	551508LUCAS	218	90575281LUCAS	221
10100388	323	180224SP	119	331670	93	552818PY	170	90577434PY	170
10100390	318	180409	119	332951	113	552818PY-YELLOW	170	90577434YELLOW	170
1013938GX	263	1H9077LLUCAS	220-221	336466	236	552819PY	170	90577636GIRLING	224
1013938X	263	20-6000-755	44	337791	236	552819PY-YELLOW	170	AAP817	210
10500050	320	201691	82	337792	236	559322LUCAS	218	AB614061LX	263
10500070	320	204-591-01	268	345435G	238	559822	236	AEU1523	237
10500073	320	215331X	263	345436G	238	562627G	180	AEU1525	237
10500080	320	215717	320	345510	61	562628G	180	AEU1609LUCAS	219
10500085	320	217090	58	345985	14	562631G	180	AEU1610LUCAS	219
10500101	319	217554	320	345985P	14	562632G	180	AEU1742	77
10500130	319	217751	320	346089	105	562731SS	158	AEU2147LX	204
10500131	319	217938	320	346936	236	562858SS	158	AEU2539GIRLING	224
10500140	319	217974	320	347474	236	563165/6/7/8	207	AEU2760	204
10500200	326	217975	320	347475	236	564704	228	AFC710010	232, 236
10500994	314	218453	236	347955	236	568858PY	170	AFC710010GALV	229, 232
1060001	125	218508	334	349172	105	568858PY-YELLOW	170	AFP710120B	286
10801353	312	219824GIRLING	224	349514	105	569746PY	170	AFP710120SS	286
10801473	312	232026LUCAS	221	349515	105	569746PY-YELLOW	170	AFU1075	264
10802363	313	234532	264	349943	104	571752X	263	AFU1075X	263
10802443	313	238018LUCAS	218	349967	105	572068PY	170	AFU1900X	263
10802603	313	238019LUCAS	218	349967LCS	105	572068PY-YELLOW	170	AK616011X	263
10802693	313	238020LUCAS	218	349988	105	572180PY	170	ALA710680G	232
10802963	313	241283G	180	349996	105	572180PY-YELLOW	170	ALQ710040K	11
10900010	312	242139	83, 86	3500520	70	572704LUCAS	219	ALR1742	232
10900021	312	242863G	180	3500810	70	572715LUCAS	219	ALR1743	232
10900029	312	244449SS	158	3500820	70	575166LUCAS	221	ALR5822	234
10900038	314	247631	204	3501010	119	575184	202	ALR5823	234
10900039	314	251323X	263	3700030	41	575383LUCAS	220-221	ALR5989LR	232
10900040	314	252165X	263	3700040	41	575396LUCAS	218	ALR5990	232
10900042	312	264195SS	158	3700090	41	575580PY	170	ALR6122G	232
10900043	312	264563G	180	3800100	41	575580PY-YELLOW	170	ALR6262	236
10900046	313	265627G	180	3800100M	41	576137KIT	212	ALR6263	236
10900047	313	266694G	212	3800103	41	576521	121	ALR6272	234
10900048	313	271581	200	3800110	41	576844	197	ALR6677G	232
10900049	313	272967G	180	3800110M	41	577681GIRLING	220	ALR6678G	232
10900051	313	272968G	180	3800113	41	579007LUCAS	218	ALR6682	234
10900052	313	2743	179	3800113M	41	579084LUCAS	218	ALR6852	232
10900053	313	2745	179	3800120	41	579085LUCAS	218	ALR8519	234
10900054	313	2746	179	3800120M	41	579408	82	ALR8520	234, 237
10900055	313	274783LUCAS	219	3800130M	41	586438LED	73, 80	ALR8572	234
10910076	312	276034G	180	390055	237	589027LUCAS	218	ALR8573	234
1357035	206	2781	179	390381	237	589284LUCAS	219	ALR8576	234
1359896	204	279678G	180	390382	237	589285LUCAS	219	ALR8577	234
13H3735LLUCAS	221	279679G	180	391127	237	589783	77	ALR8710	238
13H5952LLUCAS	218	300914	115	391141	237	589884LUCAS	220-221	ALR9803	232
160235-2	119	301147	115	391293	112	592592	236	ALR9804	232
170112	119	302532X	263	391294	112	598540SS	158	ALR9935	232
171314	119	302648	105	391295	112	599378SS	158	AM605061X	263
1770020	38	3064	179	391296	112	60024L	175	AMR2341DELAY	203
1770030	38	306460	236	391524	112	60026	175	AMR3321LUCAS	223
1770040	38	3065	179	391525	112	60146	175	AMR3850	74
1770070	38	3066	179	391546	237	60147	175	AMR3918LUCAS	221
1780020	39	3195294SP	326	391747	112	602153A	208	AMR6104LUCAS	221
1780110	39	320045X	263	391748	112	602154A	208	AMR6106LUCAS	220
1780120	39	320647	105	392222	237	606435	267	AMR6509W	73
1780130	39	320647CG	105	392223	237	605833G	208	AMR6510W	73
1780200	40	320647LCS	105	392820	112	606683S	198	AMR6526	74
1780210	40	320647RPI	105	392821	112	606696S	198	AMR6526LED	74
1780220	40	320647T	105	392822	112	608180	328	AMR6526LEDCL	74
1780230	40	320674	105	392822AE	112	624196SS	158	AMR6526LEDSDM	74
1780240	40	320674CG	105	392823	112	67187	82	AMR6527	74
1780250	39	320674LCS	105	392823AE	112	72X10	125	AMR6527LED	74
1780260	40	320674RPI	105	393046	112	740300	119	AMR6527LEDCL	74
1780270	40	320674T	105	393047	112	7450107	118	AMR6527LEDSDM	74
1780280	40	320698	105	393434	112	7450109	118	AMR6528	74
1780290	40	320699	105	393435	112	78248X	263	ANR1721PY	170
1780310	40	320719	105	395529	236	79051X	263	ANR1721PY-YELLOW	170
1780320	39	320726	105	395530	236	79221X	263	ANR2056	233
1780330	39	320726LCS	105	396698	105	802200	317	ANR2224	264
1780340	39	320737	105	396739	105	803300	317	ANR2563PY	170
1780350	39	320737CG	105	3971LUCAS	222	803301	318	ANR2563PY-YELLOW	170
1780360	39	320737LCS	105	4575902G	209	804402	318	ANR3285PY	170
1780365	39	320737RPI	105	500289SS	158	813109	315	ANR3285PY-YELLOW	170
1780370	40	320737T	105	500555	186	813209	315	ANR3304HD	165
1780380	39	330037	236	502096LUCAS	220	813300	315	ANR3305PY	170
1780385	39	330038	236	503456SS	158	813401	316	ANR3305PY-YELLOW	170
1780390	40	330326	236	504105G	200, 212	813402	316	ANR3332PY	170
1780420	40	330327	236	505196LUCAS	219	813405	316	ANR3332PY-YELLOW	170
1780430	40	330336	236	510267LUCAS	220	813407	316	ANR3410PY	170



Part Number	Page Number	Part Number	Page Number	Part Number	Page Number	Part Number	Page Number	Part Number	Page Number
ANR3410PPYYELLOW	170	CAT101160	17	DA1135	297	DA1240	239	DA1395	230
ANR3631MNH	50	CAT101170	17	DA1136	297	DA1240SS	239	DA1396	230
ANR3635	82	CAT101180	17	DA1137	297	DA1241	214	DA1400	284
ANR3679GX	55	CAT500010PCL	17	DA1138	297	DA1242	164, 171	DA1401	284
ANR3679X	55	CAT500060PMALR	17	DA1139	297	DA1243	164, 171	DA1402	284
ANR3713G	229, 233	CAT500070PMA	17	DA1140	21	DA1244	164, 171	DA1403	284
ANR3896	85	CAT500120PCL	17	DA1141	198	DA1244G	164, 171	DA1404	284
ANR4164PY	170	CAT500340PMASS	231	DA1142	280	DA1245	164, 171	DA1405	284
ANR4164PY-YELLOW	170	CAT500350PMASS	231	DA1142B	280	DA1245G	164, 171	DA1406	284
ANR4188EYELLOW	168	CAT500450PMA	17	DA1142SS	280	DA1246	164, 171	DA1407	234
ANR4188PY-YELLOW	168	CATALOGUE	342	DA1143	75	DA1247	164, 171	DA1408	234
ANR4189EYELLOW	168	CAX100060GALV	228	DA1143CL	75	DA1248	164, 171	DA1409	141
ANR4189PY	168	CAX100070GALV	228	DA1143SM	75	DA1248G	164, 171	DA1410	141
ANR4189PY-YELLOW	168	CAX100200GALV	228	DA114412V	74	DA1249	164, 171	DA1411	111
ANR4189PYE	168	CAX100210GALV	228	DA114424V	74-75	DA1252	214	DA1412	111
ANR4489	59	CDU51LLUCAS	221	DA1145	297	DA1253	214	DA1413	340
ANR4583PM	53	CN100208L	264	DA1146	79	DA1255	331	DA1414	179
ANR4583SILVER	53	CN100508L	264	DA1147	272	DA1256	331	DA1419	318
ANR4636PM	53	CN100909	264	DA1148	164	DA1257	278	DA1423	186
ANR5307MNH	50	CNG100020GALV	228	DA1148CAP	164	DA1260	297	DA1424	186
ANR5593PM	53	CNG100030GALV	228	DA1149	164	DA1260P	297	DA1425	249
ANR6091	54	CQB000140	232	DA1152	280	DA1261G	209	DA1426	58
ANR6094L	54	CRDDEF	289	DA1152B	280	DA1262G	209	DA1427	249
ANR6947PY	170	CT02	102	DA1152SS	280	DA1263G	209	DA1430	249
ANR6947PY-YELLOW	170	CT02A	102	DA1153	268	DA1264G	209	DA1436	58
AR21FV2	70	CVW500010	232	DA1155	269	DA1265G	209	DA1437	58
AR21SV2	70	CZA4705LX	263	DA1157	278	DA1266	295	DA1438T	108
AR32EM	70	CZQ000010LED	73, 80	DA1158	77	DA1267	102	DA1441	60
AR32F	70	DA1003	124	DA1159	207	DA1268	11	DA1446	80
AR32SV2	70	DA1004	124	DA1160	268	DA1269	11	DA1447	80
ARB-4344	322	DA1043	212	DA1161	268	DA1270	279	DA1448	80
ARB2018	137	DA1044	212	DA1162	266	DA1271	279	DA1450	80
ARB2091	137	DA1045	212	DA1165	198	DA1272	150	DA1452	80
ARB4158A	314	DA1057	207	DA1166	198	DA1273	74	DA1459	80
ARB4159A	314	DA1057PLLUG	207	DA1167	198	DA1273SM	74	DA1460	140
ARB4206	314	DA1059	21	DA1168	297	DA1274	75	DA1463	318
ARB4209	322	DA1062	65	DA1169	297	DA1274CL	75	DA1465	316
ARB4297	60	DA1062AMBER	65	DA1170	102	DA1274SM	75	DA1466	316
ARB4305	321	DA1062BLUE	65	DA1171	11	DA1275	239	DA1468	314
ARB501A	139	DA1062COVER	65	DA1171K	11	DA1275SS	239	DA1470	289
ARB503A	139	DA1062FOGA	65	DA1172	198	DA1277	212	DA1471	289
ARB504A	139	DA1062FOGW	65	DA1173	267	DA1277G	212	DA1472	286
ARB510	60	DA1063	65	DA1174	141	DA1278	136	DA1473	306
ARB605A	60	DA1064	65	DA1174GM	141	DA1279	136	DA1474	306
ARB705	136	DA1065	269	DA1174HM	141	DA1280	136	DA1480	306
ARB710	136	DA1070	239	DA1174SM	141	DA1281	136	DA1481	306
ARB715	136	DA1070SS	239	DA1176	267	DA1282	136	DA1482	306
ARB720	136	DA1071	299	DA1178	121	DA1283	136	DA1488	306
ARB725	136	DA1072	299, 301	DA1179	280	DA1285	160	DA1490	306
ARB730	136	DA1073	299	DA1182	206	DA1286	14	DA1493	306
ARB735	136	DA1077	75	DA1183	206	DA1287	15	DA1494	238
ARBVX17B	72	DA1077G	75	DA1185	208	DA1289	15	DA1494G	238
ARM603	70	DA1079	13	DA1186	167	DA1290	15	DA1495	238
ARM761	70	DA1080	75	DA1187	228	DA1291	75	DA1495G	238
ARMP	70	DA1080G	75	DA1188	228	DA1292	75	DA1496	238
ASJ710060	232	DA1081	91	DA1189	267	DA1293	158	DA1496G	238
ASR1186	234	DA1087	150	DA1190	75	DA1294	158	DA1497	238
ASR1187	234	DA1087FL	150	DA1191	75	DA1300	209	DA1497G	238
ASR1594	234	DA1088	150	DA1192	75	DA1300G	209	DA1498	238
ASR1595	234	DA1089	35, 45	DA1193	20	DA1305	239	DA1498G	238
AWR3994	264	DA1090	35	DA1193S	20	DA1306	239	DA1499	238
AWR5698RPI	104	DA1091	35	DA1194	20	DA1307	19	DA1499G	238
AWR5699RPI	104	DA1092	35	DA1194S	20	DA1307T	19	DA1502	192
AWR5700RPI	104	DA1108	150	DA1195	202	DA1308	19	DA1503	192
AWR5701RPI	104	DA1108TDI	150	DA1196	202	DA1308T	19	DA1504	190
AWR5702RPI	104	DA1109	150	DA1197	20	DA1309	239	DA1505	190
BAU2144	77	DA1109DEF	150	DA1197S	20	DA1311	19	DA1506	192
BKA710140	232	DA1109DIS	150	DA1198	20	DA1311T	19	DA1508	121
BL4136BUSH	184	DA1111	267	DA1198S	20	DA1312T	19	DA1510	206
BP5160036	175	DA1112	150	DA1199	169	DA1313	19	DA1511	341
BP5160045	175	DA1113	246	DA1200DEF	209	DA1313T	19	DA1512	31
BSWAG	318	DA1114	240	DA1200DEFG	209	DA1318	340	DA1513	25
BT606101LX	263	DA1115	266	DA1200DIS	209	DA1323	340	DA1514	24
BTR1759LCS	104	DA1116	266	DA1200DISG	209	DA1324	340	DA1515	306
BTR277	17	DA1117	267	DA12003	115	DA1326	85	DA1516	340
BTR3793LCS	111	DA1118	267	DA1204	115	DA1330	233-234, 237	DA1517	336
BTR7895	96	DA1119	269	DA1205	285	DA1331	248	DA1518	336
BTR7896	96	DA1120	266	DA1207	121	DA1333	248	DA1520	336
BTR7897	96	DA1121	266	DA1209	267	DA1335	340	DA1527	204
BTR7898	96	DA1123	186	DA1211	180	DA1336	208	DA1529	248
BTR7959LCS	111	DA1125	269	DA1212	180	DA1337	209	DA1530	248
BTR7964LCS	111	DA1126	82	DA1213	196	DA1338	204	DA1532	249
BTR9712LCS	111	DA1127	208	DA1214	196	DA1339	204	DA1533	307
BTR9712LOY	111	DA1128	164	DA1215	168	DA1340	204	DA1534	307
BTR9712PMA	111	DA1129	164	DA1216HD	214	DA1341	204	DA1540	307
BX110095MX	263	DA1129ADJ	164	DA1219	340	DA1342	82	DA1543	307
BYH500100X	263	DA1129G	164	DA1224	121	DA1345	251	DA1544	307
CAB500070PMALR	35	DA1129KIT	164	DA1224SN	121	DA1353	232, 236	DA1550	307
CAB500130PMALR	35	DA1129ULTRA	164	DA1225	121	DA1354	232, 236	DA1552	307
CARRIER BAG	342	DA1130	164	DA1227	332	DA1355	232	DA1554	307
CAS000150PMALR	17	DA1130TUBEKIT	164	DA1229	341	DA1357	278	DA1556	307
CAS100900LR	17	DA1131	239	DA1229PACK	342	DA1360	56	DA1557	307
CAS100910LR	17	DA1131KIT	239	DA1233	168	DA1388	197	DA1560	307
CAS100920	17	DA1132	297	DA1234	178	DA1388G	197	DA1563	307
CAS100930	17	DA1132P	297	DA1235	269	DA1389	197	DA1564	307
CAS500010PCL	17	DA1133	297	DA1236	197	DA1390	302, 305	DA1566	307
CAS500060PMA	17	DA1133P	297	DA1238	331	DA1392	239	DA1569	251
CAS500070PCL	17	DA1134	297	DA1239	331	DA1393	232	DA1577	75
CAT000180PMA	17	DA1134P	297	DA1239EU	331	DA1394	230	DA1579	251

Part Number	Page Number	Part Number	Page Number	Part Number	Page Number	Part Number	Page Number	Part Number	Page Number
DA1580	207	DA1825	82	DA2008N	236	DA2149	109	DA2388	197
DA1581	207	DA1826	251	DA2008O	236	DA2153	333	DA2388G	197
DA1582	207	DA1830	228	DA2009	236	DA2155	210	DA2389	198
DA1586	23	DA1831	82	DA2012	86	DA2156	236	DA2390	58
DA1587	23	DA1835	337	DA2013	236	DA2157	333	DA2391	254
DA1588	23	DA1836	337	DA2014	236	DA2160BLACK	333	DA2392FUSE50A	118
DA1591	321	DA1837	337	DA2015N	236	DA2160BLUE	333	DA2392XS	118
DA1592	321	DA1839	269	DA2015O	236	DA2160GREEN	333	DA2394XS	118
DA1593	321	DA1840	269	DA2016	236	DA2161BLACK	333	DA2395	212
DA1595	253	DA1841	269	DA2017N	236	DA2161BLUE	333	DA2395G	212
DA1596	207	DA1842	269	DA2017O	236	DA2161GREEN	333	DA2396	232
DA1597	207	DA1844	269	DA2019N	236	DA2162	333	DA2397	232
DA1598	204	DA1845	268	DA2019O	236	DA2163	333	DA2398	232
DA1599	204	DA1847	266	DA2021	56	DA2166	123	DA2399	232
DA1601	112	DA1860	229	DA2022	56	DA2167	123	DA2400150S	148
DA1602	112	DA1862	194	DA2023N	236	DA2170	123	DA240040S	148
DA1604	112	DA1863	194	DA2023O	236	DA2171	123	DA2400S	148
DA1605	112	DA1864	194	DA2024	232	DA2172	123	DA2401150S	148
DA1606	112	DA1869	193	DA2025	56	DA2178	196	DA240140S	148
DA1607	112	DA1875	270	DA2026	56	DA2182	123	DA2401S	148
DA1613	112	DA1876	270	DA2026N	232, 236	DA2186	168	DA2402150S	148
DA1616	112	DA1877	270	DA2026O	232, 236	DA2194	82	DA240240S	148
DA1622	254	DA1878	270	DA2027	56	DA2195	82	DA2402S	148
DA1624	340	DA1881	82	DA2029	111	DA2196	82	DA240340S	148
DA1625	328	DA1883	212	DA2030	111	DA2197	82	DA240440S	148
DA1626	336	DA1888	172	DA2035	109	DA2198	169	DA240640S	148
DA1627	336	DA1890	58	DA2035GREY	109	DA2203	169	DA240740S	148
DA1628	252	DA1895	104	DA2035LCS	109	DA2204	169	DA240940S	148
DA1630	112	DA1899	268	DA2035MESH	109	DA2206	155	DA2409S	148
DA1631	91	DA1900	206	DA2035RPI	109	DA2210	196	DA2410150S	148
DA1633	340	DA1901	238	DA2035T	109	DA2211	196	DA241040S	148
DA1634	264	DA1902	238	DA2037	138	DA2215	61	DA2410S	148
DA1635	207	DA1905	255	DA2037KY	138	DA2217	169	DA2411150S	148
DA1635RINGS	207	DA1906	207	DA2039	206	DA2220	169	DA241140S	148
DA1642	111	DA1920	124	DA2050	10	DA2225	128	DA2411S	148
DA1643	112	DA1921	305	DA2051	10	DA2225PIPE	128	DA2412150S	148
DA1644	112	DA1922	284	DA2052	10	DA2231	126	DA241240S	148
DA1647	208	DA1933	207	DA2053	10	DA2232	61	DA2412S	148
DA1647SET	208	DA1934	207	DA2054	10	DA2232BUSH	61	DA2413150S	148
DA1648	111	DA1935	231	DA2056	226	DA2232P	61	DA241340S	148
DA1649	255	DA1936	232	DA2056-300TDI	226	DA2244	125	DA2413S	148
DA1650	271	DA1937	207	DA2056-300TDI-M	227	DA2249	22	DA2414150S	148
DA1661	82	DA1938	207	DA2056-M	227	DA2250B	23	DA241440S	148
DA1662	267	DA1941	238	DA2057	226	DA2250GALV	23	DA2414S	148
DA1663	267	DA1942	238	DA2057-300TDI	226	DA2261	276	DA241840S	148
DA1665	267	DA1944	156	DA2057-300TDI-M	227	DA2274	61	DA2418S	148
DA1667	266	DA1945	156	DA2060	10	DA2274CABLE	61	DA241940S	148
DA1668	266	DA1949	157	DA2061	10	DA2301	16	DA2419S	148
DA1670	204	DA1951	239	DA2062	10	DA2314	276	DA242040S	148
DA1676	158	DA1952	239	DA2063	10	DA2316	276	DA2420S	148
DA1683	295	DA1954	156	DA2064	10	DA2318	276	DA2421	148
DA1684	295	DA1955	295	DA2065	10	DA2321	276	DA242140S	148
DA1685	295	DA1956	157	DA2066	10	DA2342L	283	DA2421S	148
DA1686	295	DA1958	260	DA2067	10	DA2342R	283	DA2425	171
DA1687	295	DA1959	260	DA2068	10	DA2343L	283	DA2426	171
DA1688	295	DA1960	21	DA2069	10	DA2343R	283	DA2427	212
DA1698	270	DA1961	21	DA2070	10	DA2344	283	DA2427G	212
DA1706	166	DA1963	279	DA2071	18	DA2351	114	DA2428	212
DA1707	166	DA1965	168	DA2090	111	DA2353	168	DA2434	52
DA1709	165	DA1966	128	DA2091	111	DA2353G	168	DA2435	52
DA1710	165	DA1968	278	DA2096	111	DA2354FUSE40A	118	DA2436	52
DA1711	165	DA1969	278	DA2098	111	DA2354XS	118	DA2437	52
DA1719	207	DA1970	279	DA2099	227, 236	DA2355	212	DA2439	52
DA1720	232, 236	DA1971	279	DA2112	206	DA2356	278	DA2440	111
DA1721	232, 236	DA1972	279	DA2112-1	206	DA2356B	278	DA2441	111
DA1722	230, 232, 236	DA1973	279	DA2112-2	206	DA2357	211	DA2442	111
DA1740	185	DA1974	279	DA2112-3	206	DA2357CP	211	DA2443	111
DA1741	185	DA1975	279	DA2112B	206	DA2357G	211	DA2444	111
DA1744BLACK	99	DA1977	297	DA2112G-EARLY	206	DA2357HD	211	DA2445	111
DA1744GREY	99	DA1978	20	DA2112G-LATER	206	DA2357HDG	211	DA2446	111
DA1745BLACK	99	DA1979	20	DA2113	206	DA2362	167	DA2447	111
DA1745GREY	99	DA1980	260	DA2114	206	DA2363	167	DA2450	52
DA1746BLACK	99	DA1981	260	DA2114B	206	DA2364	21	DA2451	52
DA1746GREY	99	DA1982	260	DA2115	206	DA2365	21	DA2452	52
DA1747BLACK	99	DA1983	260	DA2116	236	DA2366	21	DA2453	52
DA1748	284	DA1984	260	DA2118	82	DA2369	211	DA2454	52
DA1749	269	DA1985	260	DA2121	83	DA2370	211	DA2456	52
DA1756BLACK	99	DA1986	260	DA2123	82	DA2372	179	DA2457	52
DA1800	238	DA1987	260	DA2123A	82	DA2373	179	DA2458	52
DA1804	250	DA1988	260	DA2124	111	DA2374	128	DA2459	52
DA1805	250	DA1989	260	DA2125	84, 87	DA2376	208	DA2460	52
DA1806	250	DA1990	260	DA2126	155	DA2379	197	DA2461	52
DA1807	250	DA1991	260	DA2126A	155	DA2379G	197	DA2462	236
DA1808	250	DA1992	260	DA2128	16	DA2380	197	DA2463	236
DA1809	250	DA1993	260	DA2129	84	DA2380G	197	DA2464	236
DA1810	114	DA1994	260	DA2130	16	DA2381	197	DA2465	236
DA1811	251	DA1995	260	DA2133	86	DA2381G	197	DA2466	115
DA1812	252	DA1996	260	DA2134	84, 87	DA2382	197	DA2467	237
DA1813	250	DA1997	260	DA2136	83	DA2382G	197	DA2468	237
DA1814	250	DA1998	260	DA2137	83	DA2383	197	DA2469	237
DA1815	250	DA1999G	53	DA2138	84	DA2383G	197	DA2470	237
DA1816	250	DA2001N	236	DA2141	206	DA2384	197	DA2471	51
DA1817	250	DA2001O	236	DA2142	246	DA2384G	197	DA2472	51
DA1819	250	DA2002	236	DA2142G	246	DA2385	197	DA2473	51
DA1820	251	DA2003	181	DA2143	246	DA2385G	197	DA2474	51
DA1821	252	DA2004	10	DA2143G	246	DA2386	197	DA2475	51
DA1822	248	DA2005	206	DA2144	246	DA2386G	197	DA2476	51
DA1823	248	DA2006	206	DA2144G	246	DA2387	197	DA2477	51
DA1824	248	DA2007	236	DA2148	114	DA2387G	197	DA2478	51



Part Number	Page Number	Part Number	Page Number	Part Number	Page Number	Part Number	Page Number	Part Number	Page Number
DA2479	207	DA27700	236	DA2878	207	DA3086	35	DA3211	276
DA2479G	207	DA2773	156	DA2879	207	DA3092	276	DA3212	153
DA2479LR	207	DA2774	157	DA2880	207	DA3102	276	DA3213	153
DA2480	111	DA2776	157	DA2881	207	DA3119	276	DA3215G	214
DA2481	111	DA2777	212	DA2882	282	DA3121	125	DA3217	262
DA2482	111	DA2778	104, 107	DA2883	272	DA3122	125	DA3219	240
DA2483	111	DA2779	158	DA2884	69	DA3126	276	DA3236	69
DA2484	111	DA2780	181	DA2885	69	DA3128	276	DA3237	282
DA2485	111	DA2781	181	DA2886	251	DA3130	125	DA3238	50
DA2486	111	DA2782	181	DA2887	169	DA3133	276	DA3239	50
DA2487	111	DA2789	270	DA2888	169	DA3135	186	DA3240	251
DA2488	51	DA2796	13	DA2891	56	DA3136	149	DA3246	268
DA2489	51	DA2797	145	DA2892	56	DA3137	149	DA3247	271
DA2490	111	DA2799	270	DA2893	56	DA3138	151	DA3248	271
DA2491	111	DA2800BLACK	100	DA2897	135	DA3139	151	DA3249	156
DA2492	111	DA2800BLUE	100	DA2898	288	DA3140	266	DA3250	159
DA2493	111	DA2800GREEN	100	DA2899	288	DA3141	128	DA3251	159
DA2494	111	DA2800GREY	100	DA2900	28	DA3142	128	DA3252	159
DA2495	111	DA2801GREY	100	DA2901	34	DA3143	206	DA3253	159
DA2496	111	DA2801SAND	100	DA2902	290	DA3144	169	DA3254	159
DA2497	111	DA2802GREEN	100	DA2903	83	DA3145	206	DA3255	159
DA2498	240	DA2802GREY	100	DA2906	16	DA3147	328	DA3256	159
DA2499	238	DA2803BLACK	101	DA2907	16	DA3148	328	DA3257	159
DA2505	206	DA2803BLUE	101	DA2908	57	DA3149	328	DA3258	159
DA2506	206	DA2803GREY	101	DA2908EU	57	DA3151	276	DA3259	159
DA2508	206	DA2803SAND	101	DA2909	329	DA3153	125	DA3260	159
DA2508G	206	DA2804BLUE	101	DA2910	255	DA3154	125	DA3262	159
DA2509	204	DA2804GREEN	101	DA2911	255	DA3155	125	DA3263	283
DA2515	111	DA2804GREY	101	DA2912	255	DA3156	138	DA3265	255
DA2516	111	DA2804SAND	101	DA2915	192	DA3157E	328	DA3266	111
DA2517	111	DA2805GREY	101	DA2930	148	DA3157W	328	DA3267	111
DA2518	206	DA2807BLACK	100	DA2932	112	DA3160	137	DA3268	83
DA2520	236	DA2807BLUE	100	DA2933	112	DA3160A	137	DA3269	34
DA2521	236	DA2807GREEN	100	DA2934	112	DA3161	328	DA3273	235
DA2542	240	DA2807GREY	100	DA2935	112	DA3162	328	DA3274	235
DA2543N	235	DA2807SAND	100	DA2937	24	DA3163	213	DA3275	235
DA2543O	235	DA2808BLUE	100	DA2938	276	DA3163G	213	DA3276	235
DA2544N	235	DA2808GREEN	100	DA2947	197	DA3163P	213	DA3277	235
DA2544O	235	DA2808GREY	100	DA2948	83	DA3164	213	DA3278	235
DA2545	235	DA2809BLUE	100	DA2949	83	DA3164G	213	DA3279	235
DA2548	55	DA2809GREY	100	DA2950	228	DA3164P	213	DA3280	235
DA2565	227, 235	DA2810BLACK	101	DA2970	233	DA3165	213	DA3281	235
DA2602	85, 88	DA2811GREY	101	DA2970SS	230	DA3165G	213	DA3282	235
DA2603	289	DA2812BLUE	101	DA2971SS	230	DA3165P	213	DA3283	235
DA2603CF	289	DA2812GREEN	101	DA2974	306, 308	DA3166	213	DA3285	36, 45
DA2604	299	DA2812GREY	101	DA2975	287	DA3166G	213	DA3286	66
DA2608	288	DA2813BLACK	101	DA2976	278	DA3166P	213	DA3287	66
DA2609	288	DA2813GREEN	101	DA2977	289	DA3167	213	DA3292	309
DA2610	289	DA2813GREY	101	DA2982	56	DA3167G	213	DA3293	66
DA2611	302, 305, 309	DA2814GREY	101	DA2985	128	DA3167P	213	DA3294	66
DA2613	308	DA2815BLACK	100	DA2986	113	DA3167PG	213	DA3295	66
DA2616	299	DA2815GREY	100	DA2989	54, 164	DA3169	213	DA3296	167
DA2620	10	DA2816BLACK	100	DA2991	41	DA3169P	213	DA3297	167
DA2652	302, 305, 309	DA2816GREY	100	DA2992	164	DA3170B	153	DA3298	249
DA2660	210	DA2817GREY	100	DA2996	41	DA3171B	153	DA3300	147
DA2662	109	DA2818BLACK	100	DA3000	58	DA3173B	153	DA3301	147
DA2662LCS	109	DA2818GREY	100	DA3002	41	DA3174B	153	DA3302	147
DA2662MESH	109	DA2819BLACK	101	DA3010	77	DA3175B	153	DA3303	147
DA2662RPI	109	DA2819SAND	101	DA3010B	77	DA3176B	153	DA3304	147
DA2662T	109	DA2821BLACK	101	DA3015	128	DA3177B	153	DA3305	147
DA2663	209	DA2822BLACK	100	DA3016	237	DA3177BCOM	153	DA3306	147
DA2664	212	DA2822SAND	100	DA3017	237	DA3178	213	DA3307	147
DA2666	305	DA2823SAND	100	DA3018	128	DA3178G	213	DA3308	147
DA2667	235	DA2825SAND	101	DA3020	128	DA3178P	213	DA3309	147
DA2668	235	DA2826	212	DA3021	128	DA3178PG	213	DA3310	147
DA2669	235	DA2827	104	DA3022	128	DA3179	213	DA3311	147
DA2670	235	DA2828BLACK	100	DA3023	128	DA3179G	213	DA3312	147
DA2672	148	DA2829BLACK	101	DA3024	128	DA3179P	213	DA3313	147
DA2673	148	DA2830BLACK	101	DA3026	128	DA3179PG	213	DA3314	147
DA2674	148	DA2831BLACK	101	DA3028	136	DA3180	213	DA3315	147
DA2677	148	DA2832BLACK	100	DA3029	136	DA3180G	213	DA3316	147
DA2681	288	DA2833	255	DA3030	136	DA3180P	213	DA3317	147
DA2682	288	DA2834	21	DA3031	136	DA3180PG	213	DA3318	147
DA2693	113	DA2835	21	DA3035	328	DA3181	213	DA3319	147
DA2694	53	DA2836	21	DA3036	328	DA3181P	213	DA3325	253
DA2700	145	DA2837	21	DA3041	328	DA3182B	153	DA3326	253
DA2701	145	DA2839BLACK	101	DA3048	328	DA3183	153	DA3327	253
DA2702	145	DA2839SAND	101	DA3049	155	DA3184	153	DA3332	259
DA2703	145	DA2841	68	DA3049AF	155	DA3185R	140	DA3333	259
DA2704	145	DA2842	68	DA3049KD	155	DA3187	53	DA3334	259
DA2705	145	DA2843	68	DA3050	212	DA3188B	329	DA3335	145
DA2706	145	DA2844	68	DA3051	212	DA3190	196	DA3338	161
DA2707	145	DA2845	69	DA3054	212	DA3191	196	DA3339	145
DA2708	145	DA2846	69	DA3055	212	DA3192	196	DA3344	259
DA2709	145	DA2847	69	DA3056	23	DA3193	196	DA3345	240
DA2710	145	DA2848	197	DA3057	23	DA3194	196	DA3347	67
DA2711	145	DA2859	69	DA3057GLUE	23	DA3195	196	DA3348	67
DA2712	145	DA2860	229	DA3059	105	DA3196	196	DA3349	67
DA2713	145	DA2861	185	DA3059LCS	105	DA3197	196	DA3351	301
DA2714	145	DA2862	185	DA3059RPI	105	DA3198	196	DA3352	301
DA2720	213	DA2863	94	DA3059T	105	DA3199	196	DA3355	206
DA2750	236	DA2866	94	DA3066	186	DA3201	58	DA3356	206
DA2751	232	DA2867	213	DA3069	128	DA3202	329	DA3357	206
DA2752	232	DA2868	282	DA3070	34	DA3203	164	DA3358	196
DA2764	290	DA2872	309	DA3072	34	DA3205G	214	DA3359	196
DA2765	290	DA2874	207	DA3073	45	DA3206	328	DA3360	213
DA2766	290	DA2875	207	DA3073B	45	DA3208LUCAS	219	DA3361	213
DA2767	290	DA2876	207	DA3077	35	DA3209	153	DA3362	213
DA2770N	236	DA2877	207	DA3081	10	DA3210	153	DA3363	213

Part Number	Page Number	Part Number	Page Number	Part Number	Page Number	Part Number	Page Number	Part Number	Page Number
DA3364	213	DA3544	256	DA4061	125	DA4208	177	DA4329	41
DA3365	213	DA3548	55	DA4062	158	DA4210	176	DA4335	147
DA3366	213	DA3550	157	DA4063	158	DA4211	176	DA4336	147
DA3367	206	DA3551	157	DA4064	158	DA4223	156	DA4337	147
DA3368	206	DA3552	157	DA4065N	232, 236	DA4223S	159	DA4338	147
DA3369	206	DA3553	157	DA4065O	232, 236	DA4224	156	DA4339	147
DA3370	340	DA3554	46	DA4067	105	DA4226	156	DA4340	147
DA3371	340	DA3555	193	DA4070	29	DA4227	156	DA4341	147
DA3372	340	DA3600	190	DA4070B	29	DA4228	156	DA4342	10
DA3373	340	DA3613	232, 236	DA4071	10	DA4229	156	DA4343	10
DA3374	340	DA3750	257	DA4071B	10	DA4230	157	DA4344	120
DA3375	340	DA3751	257	DA4072	10	DA4231	156	DA4348	159
DA3376	340	DA3752	257	DA4072B	10	DA4232	156	DA4349	13
DA3377	340	DA3753	257	DA4073	10	DA4233	156	DA4359	159
DA3382	90-93	DA3754	257	DA4073B	10	DA4234	156	DA4363	185
DA3383	246	DA3755	257	DA4074	10	DA4235	156	DA4364	185
DA3383G	246	DA3756	257	DA4075	105	DA4236	157	DA4365	185
DA3385	153	DA3757	257	DA4075RPI	105	DA4237	156	DA4366	185
DA3386	153	DA3758	257	DA4075T	105	DA4238	156	DA4367	185
DA3387	153	DA3759	257	DA4077	13	DA4239	156	DA4368	185
DA3388	153	DA3760	257	DA4086	232, 236	DA4240	156	DA4371	159
DA3389	73	DA3761	257	DA4088	64	DA4241	156	DA4372	159
DA3390	104	DA3762	257	DA4088BULB	64	DA4242	157	DA4373	233
DA3398	214	DA3763	257	DA4088C	64	DA4243	157	DA4373S	233
DA3399	214	DA3764	257	DA4088COVER	64	DA4243EXT	157	DA4374	233
DA340140S	148	DA3765	257	DA4088W	64	DA4244	156	DA4374S	233
DA3401S	148	DA3766	257	DA4099	64	DA4245	156	DA4375	151
DA3403	340	DA3767	257	DA4100	10	DA4246	156	DA4376	151
DA3404	208	DA3768	257	DA4100B	10	DA4247	157	DA4377	151
DA3409	82	DA3769	257	DA4101	28	DA4249	157	DA4378	151
DA3411	209	DA3770	257	DA4102	202	DA4250DIS	206	DA4379	151
DA3412	209	DA3771	257	DA4102RED	202	DA4251	156	DA4392	119
DA3414	123	DA3772	257	DA4104	202	DA4259	151	DA4395	156
DA3416	209	DA3773	257	DA4104RED	202	DA4260	151	DA4396	159
DA3421	152	DA3774	257	DA4105	198	DA4261	151	DA4400	13
DA3424	207	DA3775	257	DA4106	181	DA4262	151	DA4404	16
DA3426	207	DA3776	257	DA4107	181	DA4263	151	DA4405	16
DA3428	55	DA3777	257	DA4113	276	DA4265	151	DA4406	16
DA3431	165	DA3778	257	DA4118	45	DA4266	151	DA4407	16
DA3432	82	DA3779	257	DA4119	45	DA4267	151	DA4408	16
DA3434	256	DA3920	291	DA4120	79	DA4268	151	DA4409	16
DA3435	256	DA3950	208	DA4120N	237	DA4269	151	DA4418	155
DA3436	256	DA3964	172	DA4120O	237	DA4270	151	DA4421	155
DA3437	256	DA3965	172	DA4121	45	DA4272	151	DA4422	96
DA3438	256	DA3998	156	DA4133	13	DA4273	151	DA4423	96
DA3439	256	DA4000	279	DA4134	13	DA4274	151	DA4424	96
DA3440	256	DA4000-1FK	297	DA4136	184	DA4275	149	DA4425	96
DA3441	256	DA4000SS	279	DA4136BUSH	184	DA4277	177	DA4426	96
DA3442	256	DA4001	279	DA4136EAS	184	DA4278	177	DA4427	96
DA3444	340	DA4001SS	279	DA4136FR	184	DA4279	177	DA4428	97
DA3445	340	DA4007N	237	DA4136HD	184	DA4284	185	DA4429	97
DA3446	340	DA4007O	237	DA4136HDFR	184	DA4284C	185	DA4430	97
DA3447	340	DA4008N	234, 237	DA4136HRR	184	DA4285	185	DA4431	97
DA3449	340	DA4008O	234, 237	DA4136RR	184	DA4285C	185	DA4435	155
DA3450	340	DA4013N	237	DA4141	91	DA4286	185	DA4436	155
DA3451	207	DA4013O	237	DA4142	232	DA4286C	185	DA4437	155
DA3452	207	DA4015N	237	DA4143	232	DA4286CHD	185	DA4470	93
DA3453	207	DA4015O	237	DA4144	232	DA4286CMD	185	DA4472	146
DA3454	207	DA4016N	237	DA4147	146	DA4286HD	185	DA4473	146
DA3455	207	DA4016O	237	DA4148	146	DA4286MD	185	DA4474	146
DA3456	207	DA4017	236	DA4149	147	DA4287	185	DA4475	146
DA3460	342	DA4018N	236	DA4150	147	DA4287C	185	DA4476	146
DA3460L	342	DA4018O	236	DA4151	146	DA4288	185	DA4477	146
DA3460M	342	DA4019	233	DA4152	146	DA4288C	185	DA4478	147
DA3460XXL	342	DA4020	233	DA4153	147	DA4288CHD	185	DA4479	147
DA3462	76	DA4022BLACK	98	DA4154	147	DA4288CMD	185	DA4480	147
DA3462K	76	DA4025BLACK	333	DA4155	147	DA4288HD	185	DA4481	147
DA3463	76	DA4025BLUE	333	DA4156	147	DA4288MD	185	DA4482	147
DA3463K	76	DA4025GREEN	333	DA4157	147	DA4289	185	DA4483	147
DA3466	207	DA4026	58	DA4158	146	DA4289C	185	DA4484	147
DA3467	207	DA4027	90	DA4159	147	DA4289CHD	185	DA4485	147
DA3468	207	DA4027KIT	90	DA4165	146	DA4289CMD	185	DA4486	147
DA3469	207	DA4028	104	DA4169	92	DA4289HD	185	DA4487	147
DA3470	207	DA4029	104	DA4170	92	DA4289MD	185	DA4488	146
DA3471	207	DA4030	87	DA4171	92	DA4290	159	DA4493	328
DA3473BLACK	99	DA4031	104	DA4178	210	DA4291	159	DA4496	146
DA3477	23	DA4032	232, 236, 240	DA4178RESISTOR	210	DA4292	159	DA4497	155
DA3478	340	DA4032-3SEAL	232, 236, 240	DA4179	184	DA4293	159	DA4500	246
DA3488	235-236	DA4032GREY	232, 236, 240	DA4180	184	DA4294	159	DA4501	96
DA3491	153	DA4033	232, 236, 240	DA4183	92, 94	DA4295	159	DA4502	96
DA3492	149	DA4033BRONZE	232, 236, 240	DA4185	147	DA4296	10	DA4503	93
DA3493	197	DA4033CATCH	232, 236, 240	DA4186	158	DA4296B	10	DA4505	328
DA3494	197	DA4033GREEN	232, 236, 240	DA4187	146	DA4297	10	DA4507	155
DA3497	197	DA4033GREY	232, 236, 240	DA4188	146	DA4297B	10	DA4508	233-234, 237
DA3498	153	DA4034	16	DA4189	208	DA4298	105	DA4509	233-234, 237
DA3499	271	DA4035BLUE	168	DA4190	118	DA4299	185	DA4511	18
DA3502	114	DA4036BLUE	168	DA419024V	118	DA4299C	185	DA4513	233-234, 237
DA3509	340	DA4041	104	DA4191	120	DA4300	185	DA4514	233-234, 237
DA3510	340	DA4042	104	DA4192	120	DA4300C	185	DA4515	233-234, 237
DA3511	340	DA4049	10	DA4193	120	DA4301	185	DA4516	233-234, 237
DA3513	340	DA4049B	10	DA4197	177	DA4301C	185	DA4518	233-234, 237
DA3521	51	DA4049S	10	DA4198	177	DA4302	159	DA4519	234
DA3522	51	DA4054	232, 236	DA4199	177	DA4303	159	DA4527	233-234, 237
DA3523	51	DA4055	104	DA4201	177	DA4304	159	DA4528	156
DA3524	271	DA4056	104	DA4202	177	DA4305	105	DA4528LHD	156
DA3525	266	DA4057	104	DA4203	177	DA4306	159	DA4530	234
DA3536	268	DA4058	125	DA4204	177	DA4310	335	DA4531	17
DA3542	253	DA4059	125	DA4205	177	DA4323	41	DA4532	17
DA3543	197	DA4060	28	DA4206	177	DA4326	41	DA4533	17



Part Number	Page Number	Part Number	Page Number	Part Number	Page Number	Part Number	Page Number	Part Number	Page Number
DA4534	17	DA4681	232, 236	DA4825	92	DA5023	82	DA5148	110
DA4535	17	DA4682	232, 236	DA4827	96	DA5024-150	78	DA5151	213
DA4536	17	DA4683	144	DA4828	96	DA5025	82	DA5151G	213
DA4537	159	DA4685	144	DA4829	92	DA5027	275	DA5152	207
DA4540	156	DA4686	144	DA4830	147	DA5028	122	DA5152RINGS	207
DA4545	123	DA4687	144	DA4831	147	DA5030	87	DA5156	206
DA4546	123	DA4688	144	DA4832	96	DA5034	184	DA5170	275
DA4546KIT	123	DA4689	144	DA4833	147	DA5035	214	DA5180	206
DA4547	123	DA4690	144	DA4834	147	DA5038	214	DA5181	206
DA4548	123	DA4691	285	DA4835	147	DA5039	214	DA5201	78
DA4549	146	DA4692	290	DA4836	147	DA5040	46	DA5202	334
DA4550	146	DA4695	147	DA4837	147	DA5043	46	DA5220	59
DA4551	146	DA4696	202	DA4838	147	DA5044	46	DA5221	59
DA4552	146	DA4697	208	DA4839	147	DA5045	46	DA5222	59
DA4554	146	DA4698	284	DA4840	147	DA5046	46	DA5223	59
DA4556	234, 237	DA4699	153	DA4841	147	DA5047	46	DA5240	202
DA4560	147	DA4699COM	153	DA4842	147	DA5048	46	DA5250	232
DA4563	178	DA4702	36	DA4843	147	DA5049	46	DA5300	226-227, 229, 233
DA4564	178	DA4703	36	DA4844	147	DA5050	46	DA5350	35
DA4565	328	DA4704	36	DA4845	147	DA5051	286	DA5351	35
DA4567	153	DA4705	36	DA4846	147	DA5052	78	DA5352	35
DA4568	153	DA4706	36	DA4847	147	DA5053-130	78	DA5353	35
DA4569	153	DA4707	36	DA4849	147	DA5053-150	78	DA5495	108
DA4570	153	DA4708	36	DA4850	147	DA5055	114	DA5496	115
DA4571	153	DA4709	36	DA4851	147	DA5056	114	DA5497	115
DA4572	153	DA4710	36, 45	DA4852	147	DA5057	114	DA5498	115
DA4573	153	DA4711	36	DA4853	147	DA5058	114	DA5499	115
DA4574	153	DA4712	36	DA4854	147	DA5059LH	114	DA5500	286
DA4575	153	DA4713	36	DA4855	146	DA5059RH	114	DA5501	186
DA4577	153	DA4714	36	DA4856	146	DA5060LH	114	DA5501G	186
DA4578	153	DA4715	36	DA4858	96	DA5060RH	114	DA5501M	186
DA4579	153	DA4716	36	DA4859	96	DA5066	275	DA5502	186
DA4580	153	DA4717	36	DA4860	97	DA5067	275	DA5502G	186
DA4582	153	DA4718	37	DA4861	97	DA5073	79	DA5502M	186
DA4586N	234	DA4719	37	DA4868	236	DA5075	79	DA5503	186
DA4586O	234	DA4720	37	DA4868LHD	236	DA5076	122	DA5503G	186
DA4587	126	DA4721	37	DA4869	236	DA5077	122	DA5503M	186
DA4588	328	DA4722	37	DA4869LHD	236	DA5078	118	DA5504	186
DA4589	104	DA4723	36	DA4871	286	DA5079	114	DA5504G	186
DA4590	104	DA4724	36	DA4871B	286	DA5080	114	DA5504M	186
DA4591	104	DA4725	36	DA4873	37	DA5084	281	DA5505	165
DA4592	104	DA4731	36	DA4874	282	DA5085	274	DA5506	165
DA4593	104	DA4732	37	DA4876	291	DA5087	274	DA5507	22
DA4594	104	DA4733	37	DA4877	291	DA5088	274	DA5507KIT	22
DA4595	104	DA4734	36	DA4890	229	DA5090	79	DA5507LHD	22
DA4596	104	DA4736	37	DA4891	229	DA5090A	79	DA5508	22
DA4597N	232, 236	DA4738	36	DA4892	229	DA5091	179	DA5509	186
DA4597O	232, 236	DA4739	147	DA4893	229	DA5094	78	DA5510	165
DA4598	283	DA4740	147	DA4894	229	DA5094-150	78	DA5511A	90
DA4599	285	DA4741	235	DA4895	229	DA5095	274	DA5513	149
DA4600	144	DA4742	235	DA4896	229	DA5097	184	DA5526	149
DA4601	144	DA4743	152	DA4897	229	DA5100	82	DA5527	186
DA4602	144	DA4744	152	DA4900	147	DA5101	110	DA5528	186
DA4603	144	DA4748	205	DA4901	147	DA5102	110	DA5537	149
DA4604	144	DA4749	205	DA4902	147	DA5103	110	DA5539	90
DA4605	144	DA4750	205	DA4903	147	DA5104	110	DA5541	186
DA4606	144	DA4751	150, 205	DA4904	147	DA5105	110	DA5550	211
DA4607	144	DA4780	232, 236	DA4905	147	DA5106	110	DA5550G	211
DA4608	144	DA4781	153	DA4906	147	DA5109	110	DA5551	211
DA4609	144	DA4782	232, 236	DA4907	147	DA5110	204	DA5551G	211
DA4610	144	DA4785	232, 236	DA4908	147	DA5111	110	DA5551KIT	211
DA4611	144	DA4786	232, 236	DA4910	106	DA5112	110	DA5552	211
DA4612	144	DA4787	232, 236	DA4911	106	DA5113	110	DA5554	92
DA4613	144	DA4788	176	DA4912	106	DA5114	110	DA5555	92
DA4614	144	DA4789	230	DA4913	106	DA5115	110	DA5556	92
DA4615	144	DA4790	286	DA4914	106	DA5116	110	DA5557	92
DA4616	144	DA4790B	286	DA4915	106	DA5117	110	DA5558	211
DA4617	144	DA4791	286	DA4916	106	DA5118	110	DA5559	211
DA4618	144	DA4791B	286	DA4917	106	DA5120	207	DA5561	92
DA4619	144	DA4792	286	DA4918	106	DA5121	207	DA5562	92
DA4622	144	DA4792B	286	DA4919	106	DA5121025	207	DA5570	35
DA4623	144	DA4793	286	DA4920	106	DA5121025AE	207	DA5600	126
DA4624	144	DA4793B	286	DA4930	232	DA5121050AE	207	DA5601	126
DA4625	144	DA4794	286	DA4931	232	DA5121AE	207	DA5602	92
DA4626	144	DA4794B	286	DA4958	118	DA5122	110	DA5603	108
DA4627	144	DA4795	297	DA4960	252	DA5123	110	DA5603E	108
DA4628	144	DA4800	97	DA4961	252	DA5124	110	DA5604	134
DA4629	290	DA4801	97	DA4962	252	DA5126	207	DA5607	125
DA4629B	290	DA4802	96	DA4963	249	DA5127	207	DA5609	134
DA4631	152	DA4803	96	DA4964	249	DA5127020	207	DA5620	134
DA4632	152	DA4804	97	DA4965	249	DA5128	206	DA5621	134
DA4633	152	DA4805	97	DA4966	249	DA5129	206	DA5621K	135
DA4634	152	DA4806	97	DA4980	281	DA5130	232	DA5622	134
DA4635	152	DA4807	97	DA4985	118	DA5131	232	DA5623	134
DA4636	328	DA4808	97	DA5004	54	DA5132	206	DA5625	22
DA4637	151	DA4809	97	DA5004S	54	DA5134	207	DA5626	11
DA4649	111	DA4810	23	DA5007	184	DA5135	178	DA5627	108
DA4650	291	DA4811	23	DA5008	184	DA5136	184	DA5627E	108
DA4654	291	DA4812	97	DA5010	178	DA5137	184	DA5628	108
DA4659	291	DA4813	97	DA5011	178	DA5138	110	DA5628E	108
DA4660	291	DA4814	29	DA5012	178	DA5139	110	DA5629	108
DA4661	291	DA4817	335	DA5014	77	DA5140	110	DA5629E	108
DA4664	282	DA4818	29	DA5016-130	78	DA5141	110	DA5630	108
DA4664MOTORLH	282	DA4819	96	DA5016-150	78	DA5142	109	DA5630E	108
DA4664MOTORRH	282	DA4820	97	DA5017	73	DA5143	109	DA5631	269
DA4667	155	DA4821	97	DA5018	78	DA5144	109	DA5632	108
DA4678	236	DA4822	92	DA5019	78	DA5145	109	DA5632E	108
DA4679	284	DA4823	97	DA5020	78	DA5146	110	DA5633	108
DA4680	232, 236	DA4824	97	DA5021	78	DA5147	110	DA5633E	108

Part Number	Page Number	Part Number	Page Number	Part Number	Page Number	Part Number	Page Number	Part Number	Page Number
DA5634	108	DA6005	243	DA6054	213	DA6130	267	DA6310	262
DA5634E	108	DA6006	243-244	DA6055	213	DA6131	267	DA6314	262
DA5635	108	DA6006COM	243-244	DA6056	213	DA6132	269	DA6322	167
DA5635E	108	DA6006P	243-244	DA6057	213	DA6133	268	DA6322L	167
DA5637	108	DA6007	243-244	DA6058	213	DA6134	269	DA6323	167
DA5637E	108	DA6007CAT	243-244	DA6059	213	DA6135	269	DA6323L	167
DA5638	104	DA6007COM	243-244	DA6060	213	DA6136	268	DA6323XD	173
DA5642	276	DA6007P	243-244	DA6061	213	DA6200	257	DA6324	167
DA5643	134	DA6008	243	DA6062	213	DA6201	257	DA6326	262
DA5645	134	DA6009	243	DA6063	213	DA6202	257	DA6337	167
DA5646	18	DA6010	243	DA6064	213	DA6203	257	DA6338	167
DA5646KIT	18	DA6010LR	243	DA6065	245	DA6204	257	DA6339	186
DA5647	18	DA6010P	243	DA6065LR	245	DA6205	257	DA633925	186
DA5647KIT	18	DA6011	243	DA6065P	245	DA6206	257	DA6341	168
DA5653	299	DA6012	243	DA6066	245	DA6207	257	DA6342	168
DA5654	299	DA6013	243	DA6066LR	245	DA6208	257	DA6343	54
DA5655	299	DA6013P	243	DA6066P	245	DA6209	257	DA6344	168
DA5658	301	DA6014	243	DA6067	245	DA6210	257	DA6345	168
DA5659	301	DA6014LR	243	DA6067LR	245	DA6211	257	DA6348	254
DA5660	301	DA6014P	243	DA6067P	245	DA6212	257	DA6350	186
DA5661	301, 303	DA6015	243	DA6068	245	DA6213	257	DA6351	186
DA5662	303	DA6015COM	243	DA6068LR	245	DA6214	257	DA6352	186
DA5663	309	DA6015LR	243	DA6068P	245	DA6215	257	DA6353	186
DA5664	303	DA6015P	243	DA6070	24-25	DA6216	257	DA6354	186
DA5667	301	DA6016	244	DA6071	24	DA6217	257	DA6355	186
DA5668	301	DA6017	244	DA6072	24	DA6218	257	DA6356	186
DA5669	303	DA6018	244	DA6073	25	DA6219	257	DA6358	252
DA5670	303	DA6019	244	DA6074	25	DA6220	257	DA6360	262
DA5673	108	DA6020	244	DA6075	25	DA6221	257	DA6364	262
DA5673E	108	DA6021	244	DA6076	25	DA6222	257	DA6365	262
DA5674	108	DA6022	244	DA6077	25	DA6223	257	DA6366	262
DA5674E	108	DA6023	244	DA6078	24	DA6224	257	DA6367	237
DA5675	108	DA6024	244	DA6079	24	DA6225	257	DA6368	250
DA5675E	108	DA6025	244	DA6080	150	DA6226	257	DA6369	250
DA5676	108	DA6026	244	DA6081	150	DA6227	257	DA6370	258
DA5676E	108	DA6027	244	DA6082	150	DA6228	257	DA6371	258
DA5677	108	DA6027P	244	DA6084	150	DA6229	257	DA6372	251
DA5677E	108	DA6028	244	DA6085	246	DA6230	257	DA6373	251
DA5681	134	DA6028P	244	DA6085G	246	DA6231	257	DA6374	251
DA5684	202	DA6029	244	DA6086	244-245	DA6232	257	DA6375	251
DA5685	108	DA6029P	244	DA6086CAT	244-245	DA6233	257	DA6376	250
DA5686	108	DA6030	245	DA6086LR	244-245	DA6234	257	DA6377	250
DA5687	108	DA6030COM	245	DA6086P	244-245	DA6235	257	DA6378	250
DA5688	108	DA6030LR	245	DA6087LR	244	DA6236	257	DA6379	250
DA5689	303	DA6030P	245	DA6087P	244	DA6237	257	DA6380	250
DA5691	134	DA6031	245	DA6088	244-245	DA6238	257	DA6381	250
DA5692	56	DA6031LR	245	DA6088LR	244-245	DA6239	257	DA6382	258
DA5693	104	DA6031P	245	DA6088P	244-245	DA6240	257	DA6384	258
DA5694	104	DA6032	243	DA6089	243-245	DA6241	257	DA6386	259
DA5699	142	DA6033	243	DA6089LR	243-245	DA6242	257	DA6388BLK	261
DA5700	121	DA6034	243	DA6089P	243-245	DA6243	257	DA6388BW	261
DA5701	121	DA6035	244-245	DA6091	244-245	DA6244	257	DA6388GG	261
DA5704	121	DA6035CAT	244-245	DA6091CAT	244-245	DA6245	257	DA6390	259
DA5705	121	DA6035COM	244-245	DA6091LR	244-245	DA6247	212	DA6391	259
DA5709	121	DA6035LR	244-245	DA6091P	244-245	DA6248	273	DA6393	259
DA5710	121	DA6035P	244-245	DA6093	25	DA6250	211	DA6394	259
DA5711	121	DA6036	245	DA6094	25	DA6250G	211	DA6396	259
DA5712	121	DA6036LR	245	DA6095	245	DA6251	211	DA6397	259
DA5713	121	DA6036P	245	DA6095LR	245	DA6252	120	DA6398	259
DA5714	207	DA6037	244-245	DA6095P	245	DA6253	60	DA6430CABLE	192
DA5717	114	DA6037LR	244-245	DA6096	245	DA6254	120	DA6433	190, 192
DA5717W	114	DA6037P	244-245	DA6096LR	245	DA6259	257	DA6433EU	190, 192
DA5726	291	DA6038	243	DA6096P	245	DA6260	253	DA6436	258
DA5727	291	DA6038CAT	243	DA6097	245	DA6261	253	DA6437	237
DA5728	291	DA6038COM	243	DA6097LR	245	DA6264	253	DA6440	213
DA5729	291	DA6038LR	243	DA6097P	245	DA6265	253	DA6441	262
DA5730	291	DA6038P	243	DA6098	245	DA6266	254	DA6447	259
DA5734	291	DA6039	243	DA6098LR	245	DA6267	254	DA6449	178
DA5735	291	DA6039LR	243	DA6099	245	DA6268	253	DA6454	257
DA5736	291	DA6039P	243	DA6099LR	245	DA6269	253	DA6455	257
DA5737	291	DA6040	243	DA6099P	245	DA6270	253	DA6456	257
DA5742	291	DA6040CAT	243	DA6100	232	DA6271	253	DA6457	257
DA5801A	90	DA6040COM	243	DA6101	232	DA6272	253	DA6458	257
DA5803	91	DA6040LR	243	DA6102	232	DA6273	253	DA6459	257
DA5805	91	DA6040P	243	DA6103	232	DA6274	253	DA6460	257
DA5806	91	DA6041	244	DA6104	232	DA6275	253	DA6461	257
DA5810	91	DA6041CAT	244	DA6107	25	DA6276	261	DA6462	257
DA5812	90	DA6041COM	244	DA6108	25	DA6278	262	DA6463	257
DA5813	91	DA6041LR	244	DA6109	243	DA6280K	77	DA6464	257
DA5814	91	DA6041P	244	DA6109CAT	243	DA6281K	77	DA6465	257
DA6000	243	DA6042	198	DA6109COM	243	DA6282	75	DA6466	257
DA6001	243	DA6042G	198	DA6109LR	243	DA6282K	75	DA6467	257
DA6001CAT	243	DA6043	198	DA6109P	243	DA6283	75	DA6468	257
DA6001COM	243	DA6043G	198	DA6110	297	DA6283K	75	DA6469	257
DA6001P	243	DA6044	198	DA6111	269	DA6287G	249	DA6470	257
DA6002	243	DA6044G	198	DA6112	266	DA6288	250	DA6471	257
DA6002CAT	243	DA6045	198	DA6113	272	DA6289	250	DA6472	257
DA6002COM	243	DA6046	198	DA6114	268	DA6290	301	DA6473	257
DA6002P	243	DA6046G	198	DA6116	266	DA6291	250	DA6474	257
DA6003	243	DA6047	198	DA6118	267	DA6292	250	DA6475	257
DA6003CAT	243	DA6047G	198	DA6120	266	DA6293	252	DA6476	257
DA6003COM	243	DA6048	245	DA6121	25	DA6294	252	DA6477	257
DA6003P	243	DA6048LR	245	DA6122	245	DA6296	255	DA6478	257
DA6004	243	DA6048P	245	DA6122LR	245	DA6300	262	DA6479	257
DA6004CAT	243	DA6049	169	DA6122P	245	DA6301	262	DA6480	257
DA6004COM	243	DA6050	213	DA6123LR	244-245	DA6304	262	DA6481	257
DA6004P	243	DA6051	213	DA6123P	244-245	DA6305	262	DA6482	257
DA6004PCAT	243	DA6052	213	DA6124	266	DA6306	262	DA6483	257
DA6004XD	243	DA6053	213	DA6129	266	DA6307	262	DA6484	259



Part Number	Page Number	Part Number	Page Number	Part Number	Page Number	Part Number	Page Number	Part Number	Page Number
DA6493	288	DA6832	315	DA7423	198	DA8050	342	DA8899	169
DA6497	258	DA6834	315	DA7424	198	DA8051	335	DA8900	226
DA6498	258	DA6836	119	DA7425	198	DA8052	335	DA8901	226
DA6500	122	DA6837	119	DA7426	198	DA8053	335	DA8902N	235
DA6502	64	DA6840	315	DA7427	198	DA8054	335	DA8902O	235
DA6503	64	DA6841	179	DA7428	198	DA8055	335	DA8903	227, 235
DA6507	198	DA6842	60	DA7429	198	DA8056	335	DA8906	226
DA6507G	198	DA6844	315	DA7430	198	DA8057	335	DA8906-M	227
DA6508	198	DA6859	254	DA7431	198	DA8058	335	DA8907	226
DA6508G	198	DA6861	273	DA7432	198	DA8059	335	DA8907-M	227
DA6509	198	DA6862	273	DA7433	198	DA8060	335	DA8910	179
DA6509G	198	DA6863	273	DA7434	198	DA8061	335	DA8911	175
DA6520	240	DA6866	273	DA7435	198	DA8062	335	DA8912	179
DA6529	34	DA6867	273	DA7436	198	DA8063	335	DA8913	175
DA6537	34	DA6892	280	DA7437	198	DA8064	335	DA8914	179
DA6538	22	DA6893	280	DA7438	198	DA8065	335	DA8915	179
DA6539	22	DA6894	279	DA7439	198	DA8066	335	DA8916	175
DA6540	23	DA6895	279	DA7440	198	DA8067	335	DA8917	175
DA6541	139	DA6897	279	DA7441	198	DA8068	335	DA8918	179
DA6550	268	DA6898	279	DA7442	198	DA8069	335	DA8920	179
DA6551	278	DA6900	280	DA7443	198	DA8070	335	DA8921	175
DA6552	278, 281	DA6901	280	DA7446	198	DA8071	335	DA8922	179
DA6554	283	DA6902	279	DA7460	268	DA8072	335	DA8923	179
DA6555	283	DA6903	279	DA7461	272	DA8073	335	DA8924	179
DA6600	286	DA7011	28	DA7463	272	DA8074	335	DA8925	186
DA6601	332	DA7011SS	28	DA7464	272	DA8075	335	DA8926	120
DA6602	332	DA7012	28	DA7465	272	DA8076	294	DA8928	138
DA6606	261	DA7012SS	28	DA7466	272	DA8077	342	DA8929	319
DA6607	261	DA7014	206	DA7477	269	DA8078	342	DA8930	60
DA6609	261	DA7195	202	DA7481	282	DA8079	342	DA8931	60
DA6614	262	DA7200	166	DA7484	268	DA8080	342	DA8933	312
DA6615	259	DA7201	166	DA7485	270	DA8081	342	DA8934	120
DA6616	259	DA7202	166	DA7486	270	DA8082	341	DA8935	285
DA6617	259	DA7203	166	DA7487	270	DA8083	294	DA8936	285
DA6618	65	DA7204	166	DA7488	267	DA8084	294	DA8937	285
DA6619	64-65	DA7205	166	DA7489	270	DA8085	294	DA8938	285
DA6620	207	DA7206	166	DA7490	270	DA8086	294	DA8943	285
DA6621	207	DA7207	166	DA7509	214	DA8087	294	DA8944	285
DA6622	207	DA7208	166	DA7509E	214	DA8088	294	DA8945	285
DA6623	207	DA7211	214	DA7528	167	DA8089	294	DA8946	285
DA6624	207	DA7211E	214	DA7529	214	DA8090	294	DA8947	285
DA6625	207	DA7212	166	DA7529E	214	DA8091	294	DA8948	285
DA6626	204	DA7213E	214	DA7530	22	DA8092	294	DA8949	285
DA6627	204	DA7214	214	DA7530B	22	DA8093	294	DA8950	285
DA6628	204	DA7214E	214	DA7531	168	DA8094	294	DA8951	169
DA6629	34	DA7215	214	DA7532	22	DA8095	294	DA8952	169
DA6633	65	DA7216	214	DA7533	31	DA8096	294	DA8953	285
DA6638	267	DA7217	214	DA7534B	19	DA8097	294	DA8954	285
DA6641	264	DA7288	271	DA7535	22	DA8098	294	DA8955	179
DA6642	257	DA7301	107	DA7535B	22	DA8099	341	DA8956	119
DA6643	267	DA7302	107	DA7536	22	DA8100	342	DA8958	288
DA6644	257	DA7303	107	DA7537	134	DA8101	341	DA8959	119
DA6645	232	DA7304	107	DA7539	266	DA8102	294	DA8960	119
DA6646	232	DA7305	107	DA7561	148	DA8109G	341	DA8961	119
DA6647	259	DA7306	107	DA7611	301, 303, 309	DA8110	341-342	DA8963	154
DA6648	227, 233	DA7307	107	DA7637	280	DA8111	341	DA8964	154
DA6649	258	DA7308	107	DA7638	280	DA8112	341	DA8965	154
DA6650	257	DA7310	107	DA7960	284	DA8113	341	DA8966	154
DA6651	122	DA7311	107	DA8002	341	DA8114	341	DA8967	154
DA6652	122	DA7314	107	DA8003	341	DA8114X	342	DA8968	154
DA6653	259	DA7315	107	DA8003X	341-342	DA8150	294	DA8970D	154
DA6654	232	DA7316	107	DA8004	341	DA8200	231	DA8970P	154
DA6655	232	DA7317	107	DA8005	342	DA8530	74	DA8971	154
DA6656	207	DA7330	332	DA8006	342	DA8532	74	DA8972	154
DA6657	207	DA7331	332	DA8007	342	DA8533	332	DA8973	154
DA6658	207	DA7332	332	DA8008	342	DA8534	30	DA8974	154
DA6659	207	DA7333	332	DA8009	342	DA8535	74	DA8976	154
DA6660	207	DA7334	332	DA8010	342	DA8600	72	DA8977	154
DA6661	207	DA7336	137	DA8011	342	DA8600LED	72	DA8978	154
DA6662	207	DA7357	198	DA8012	342	DA8600XS	72	DA8981	318
DA6663	207	DA7360	268	DA8013	342	DA8601	281	DA8987	119
DA6665	257	DA7361	268	DA8014	341	DA8857	287	DA8988	119
DA6668	227, 233	DA7362	269	DA8015	341	DA8858	287	DA8994	119
DA6669	227, 233	DA7364	266	DA8016	341	DA8859	287	DA8995	137
DA6670	227, 233	DA7370	112	DA8016PACK	342	DA8860	293	DA8998	60
DA6672	261	DA7371	112	DA8017	341	DA8861	293	DA9011	121
DA6673	261	DA7399	271	DA8018	342	DA8862	293	DA9012	332
DA6674	282	DA7400	198	DA8019	342	DA8862LOOM	293	DA9013	332
DA6675	24	DA7401	198	DA8020	342	DA8862MONITOR	293	DA9015	160
DA6676	24	DA7402	198	DA8021	342	DA8863	293	DA9016	160
DA6677	25	DA7403	198	DA8023PACK	342	DA8864	293	DA9017	160
DA6678	282	DA7404	198	DA8024	341	DA8865	293	DA9018	160
DA6701	233-234, 237	DA7405	198	DA8025	341	DA8866	293	DA9019	160
DA6799	273	DA7406	198	DA8028	342	DA8867	293	DA9029	160
DA6803	175	DA7407	198	DA8029	342	DA8868	285	DA9110	183
DA6804	175	DA7408	198	DA8037	341	DA8869	285	DA9200	182
DA6805	175	DA7409	198	DA8038	341	DA8880	292	DA9201	182
DA6806	175	DA7410	198	DA8039	342	DA8881	292	DA9223	198
DA6809	254	DA7411	198	DA8040	342	DA8882	292	DA9224	198
DA6811	156	DA7412	198	DA8041	342	DA8883	292	DA9500	72
DA6813	156	DA7413	198	DA8042	341	DA8884	292	DA9500LED	72
DA6814	156	DA7414	198	DA8042PACK	342	DA8884DOCK	292	DA9500XS	72
DA6815	156	DA7415	198	DA8043	341	DA8890	205	DA9992	255
DA6817	156	DA7417	198	DA8044	257	DA8891	205	DA9993	321
DA6823	60	DA7418	198	DA8045	342	DA8893	305, 308-309	DA9994	321
DA6824	60	DA7419	198	DA8046	342	DA8894	205	DACS001	44
DA6828	315	DA7420	198	DA8047	342	DA8895	205	DB1000	138
DA6829	315	DA7421	198	DA8048	342	DA8896	205	DB1001	139
DA6831	315	DA7422	198	DA8049	342	DA8897	169	DB1002	137

Part Number	Page Number	Part Number	Page Number	Part Number	Page Number	Part Number	Page Number	Part Number	Page Number
DB1003	136	DB9500i	131	EGP1889PY	170	JEF100220	210	LR003156G	249
DB1004	136	DB9500i24	131	EJP7738LX	263	JFC102550B	73	LR003322	17
DB1005	136	DB9500iR	131	EJP7813	148	JHC500150SCREW	208	LR003324	17
DB1006	136	DC5000	174	ERC2886W	155	JLR-303-1619	268	LR003894	95
DB1007	136	DC5000L	174	ERC3256LUCAS	222	JGD500080V	210	LR003905	299, 301, 303, 309
DB1008	137	DC5001	174	ERC4536K	202	KAH000060G	59	LR004088	64
DB1009	137	DC5001L	174	ERR3340X	204	KBM100450	55	LR004404S	206
DB1010	138	DC5002	174	ERR4686BLUE	205	KBM100460	55	LR005039	96
DB1011	136	DC5002L	174	ERR4686RED	205	KBM100470	55	LR005040	93
DB1012	137	DC5003	174	ERR5027COM	204	KBM100480	55	LR005058LR	101
DB1014	139	DC5003L	174	ERR6299X	204	KBM100490	55	LR005059LR	101
DB1015	138	DC5004	174, 186	ESR158SS	158	KBM100500	55	LR005613	93
DB1016	138	DC5005	174, 186	ESR2297SS	158	KBM100510	55	LR005615	93
DB1017	138	DC6000	174	ESR2381SS	158	KBM100520	55	LR005649PY	169
DB1017P	138	DC6000L	174	ESR2383SS	158	KBM100530	55	LR005710LR	257
DB1018	140	DC6000LL	174	ESR2391S	159	KBM100540	55	LR005714LR	257
DB1019	140	DC6001	174	ESR2740	159	KBM500020	55	LR005919	83
DB1020	140	DC6001L	174	ESR3195SS	158	KBM500030	55	LR005920	83
DB1021	140	DC6001LL	174	ESR3495SS	158	KBM500040	55	LR005921	83
DB1035	139	DC6002	174	ESR3538SS	158	KBM500050	55	LR006237LR	98
DB12000i	131	DC6003	174	ESR358SS	158	KBM500060	55	LR006238LR	98
DB12000i24	131	DC6004	174, 186	ESR4526SS	158	KBM500070	55	LR006247G	249
DB12000i24R	131	DC6005	174, 186	ESR4686X	204	KBM500080	55	LR006253LR	238
DB12000iR	131	DC6006	174, 186	ESR454S	158	KBM500090LR	55	LR006401	94
DB1300	133	DC6007	174	EST110075/76ES	211	KBM500100	55	LR006401LR	94
DB1301	133	DC6009	174, 186	ETC4291/2/3/4	207	KBM500110	55	LR006433LR	98
DB1302	133	DC6010	174	ETC5835EBLACK	202	KBM500120LR	55	LR007055G	199
DB1303	133	DC6011	174	ETC5835ERED	202	KBM500130LR	55	LR007205-6BJ	196
DB1304	133	DC6012	174	ETC5835K	202	KBM500140	55	LR007205-6BJG	196
DB1307	133, 136	DC6013	174	ETC8496LUCAS	223	KBM500150	55	LR007221	83
DB1308	138	DC6014	174	EXTERIOR STICKER	342	KBM500160	55	LR007222	83
DB1309	133	DC7000	171	FB10811LX	263	KBM500170	55	LR007223	83
DB1310	135	DC7001	171	FENDER	329	KBM500180	55	LR007320	91
DB1310GALV	135	DC7002	171	FENDER AFRICA	329	KBM500190	55	LR007954	301, 303, 309
DB1310R	135	DC7003	171	FENDER HARBOUR	329	KBM500200	55	LR008361	278
DB1310RGALV	135	DC7004	171	FENDER RESCUE	329	KBM500210	55	LR008375	28
DB1313	135	DC7005	171	FJL101530PMA	115	KBP10001	54	LR008375B	28
DB1313-24V	135	DC7006	171	FJL101680PMA	115	KNB100640	82	LR008375SS	28
DB1313GALV	135	DC7007	171	FJL101710PMA	115	KNB100640G	82	LR008379	28
DB1313R	135	DC7008	171	FK64	175	KNK500060	86	LR008379B	28
DB1313RGALV	135	DC7009	171	FKDEF	289	KNK500070	86	LR008379SS	28
DB1314	139	DC7010	171	FQJ500240KIT	240	KNR500010	11	LR008556	211
DB1315	136	DC7011	171	FQJ500250KIT	240	KNW500020	84, 87	LR008713	302-303
DB1316	136	DC7012	168	FQM100761KIT	240	KVB000290	233	LR009366	211
DB1317	136	DC7013	168	FQM100771KIT	240	KVB500060	233	LR010673	196
DB1318	139	DC7014	171	FRC2464X	263	KVB500230	233	LR010674	196
DB1319	135	DC7100	171	FRC3875	197	KVD001010-M	227	LR011870	58
DB1319R	135	DC7101	171	FRC4142SS	196	KVD001030-M	227	LR011870HD	58
DB1320	135	DC7102	171	FRC5413X	263	KVD500710	226	LR013164G	209
DB1320R	135	DC7103	171	FRC5806HD	164	KVD500710-M	227	LR014145HD	165
DB1321	135	DC7104	171	FRC6968X	263	KVD500730	226	LR014147	169
DB1321R	135	DC7105	171	FRC7064X	263	KVD500730-M	227	LR015339PY	197
DB1322	137	DC7106	171	FRC7437X	263	KVU101420GALV	229	LR016176G	199
DB1323	137	DC7107	171	FRC9845X	263	LANDY	329	LR016192G	199
DB1324	135	DC7108	171	FRC9847X	263	LANDY FACTORY	329	LR016318GR	207
DB1324R	135	DC7109	171	FRC9849X	263	LANDY HARVEST	329	LR016319GR	207
DB1325	135	DC7110	171	FRC9851X	263	LANDY NEW HOME	329	LR016430	29
DB1325R	135	DC7111	171	FRC9853X	263	LCJ000050LKIT	204	LR016430MT	29
DB1328	133	DC7112	168	FS108207LX	263	LDF500180COM	204	LR016683G	198
DB1328H	133	DC7113	168	FS108257LX	263	LEKR323SLA	338	LR017770LR	102
DB1329	137	DC7114	171	FS108307LX	263	LFMG363WTA	338	LR017951G	199
DB1330	133	DC8000	173	FTC1507	197	LFP101320LH	207	LR017952G	199
DB1331	133	DC8001	173	FTC1740G	196	LFT000100H	207	LR017953G	199
DB1332	133	DEFENDER STICKER	342	FTC2957HD	211	LFT100390LH	207	LR017960GALV	229
DB1334	133	DKC500010PMDLR	334	FTC2957HDKIT	211	LFTY420GNA	339	LR017961GALV	229
DB1336	133	DKD100620M	203	FTC3697X	263	LGDC921GNY	338	LR018026G	199
DB1337	133	DKD100630M	203	FTC3846G	199	LGDC922SLY	338	LR018752V	204
DB1338	133	DKP5279L	264	FTC4746BUSH	212	LGGF391BKA	339	LR018753V	204
DB1339	133	DLB101770M	203	FTC5150X	263	LGGF397MXA	337	LR019162GALV	229
DB1340	133	DLB102LUCAS	222	FTC5200HD	211	LGKR468IVA	338	LR019163GALV	229
DB1341	133, 136	DLB105LUCAS	222	FWJ500020PMA	109	LGKR468NVA	338	LR019727	251
DB1343	133	DLB110LUCAS	222	GBH134GIRLING	224	LGKR515BKA	338	LR019727LR	249
DB1344	135	DPB000270	11	GLOVEMX	138	LGMG474NVA	338	LR020614	29
DB1344R	135	DPB000270GALV	11	GLOVES	138	LGNB517NVA	339	LR020614MT	29
DB1345	135	DPB500075LML	238	HAD501820RPI	104	LHTT619NVA	339	LR021899	200
DB1345R	135	DPT100070	281	HAD501850LOY	104	LJFM008MXA	339	LR021899G	200
DB1346	135	DQN500040	18	HAD501870LOY	104	LJTT015BKA	339	LR022460	251
DB1346R	135	DQN500050	18	HAD501870RPI	104	LJTY009BNA	339	LR022688G	209
DB1347	135	DYC101420	264	HAG100970LOY	104	LJUM123NVA	339	LR022983SENSOR	206
DB1347R	135	DYC101420X	263	HAI101400LOY	104	LK01A	102	LR023288	251
DB1348	135	DYG100230	264	HAI101410LOY	104	LKTT063BKA	339	LR023573	176
DB1348R	135	DZM100080X	263	HBA106180LOY	104	LOGOBOARD	342	LR023580	176
DB1349	135	EAH000261PMLR	98	HBA106190LOY	104	LPF500020	208	LR023889LR	255
DB1349R	135	EAH000271PMLR	98	HBD000320JMNLR	101	LPX100590XD	208	LR023964	172
DB1350	135	EAH000300SUN	98	HBD000320LUPLR	101	LR001018G	199	LR023964G	172
DB1350R	135	EAH000310LUPLR	98	HCA106010LOY	104	LR001019G	199	LR024442B	176
DB1352	133	EAH500015SMSLR	98	HGA500500	104	LR001020	200	LR024474HD	165
DB1352R	133	EAH500052PMLR	98	IAB500104E	214	LR001381X	55	LR024835G	249
DB1353	137	EAH500100PMLR	98	INTERIOR STICKER	342	LR002417LR	35	LR025111	172
DB1354	133	EAH500290LUPLR	98	IPM000010	105	LR002424LR	93	LR025946G	199
DB1355	133	EAH500290PVALR	98	IPN500050X	263	LR002485LR	98	LR026221	200
DB1355R	133	EAH500320PMLR	98	ISG000040	18	LR002516	93	LR026221DT	146
DB1356	133	EAH500520	93	ISG000050	18	LR002521LR	90	LR026221G	200
DB1357	139	EAH500530	93	IYH000030X	263	LR002525	309	LR026592LR	308
DB1359	276	EAH500540	93	IYK500010	251	LR002626HD	165	LR026593LR	308
DB1360	133	EBF000040LR	95	IYK500010-20L	251	LR002748	251	LR026595LR	308
DB1500	141	EBF500010LR	94	IYK500010G	249	LR002773	31	LR026596LR	308
DB2000	132	EBF500020LR	95	JAK000065MMM	303	LR002876HD	165	LR027107G	199
DB6000	132	EBN500041	303	JEF100150	210	LR003156	251	LR027123G	199



Part Number	Page Number	Part Number	Page Number	Part Number	Page Number	Part Number	Page Number	Part Number	Page Number
LR027545	232	LR051592K	166	LR087093B	176	LR161907G	201	MTC5383	236
LR027546	232	LR051594G	166	LR088859G	172	LR161912G	201	MTC5383BK	236
LR027664	58	LR051594K	166	LR094546LR	52	LR161918G	201	MTC6332BRKT	231
LR029294KIT	28	LR05161PY	169	LR094547LR	52	LR161919G	201	MTC6332KIT	231
LR029295/7KIT	28	LR051614G	166	LR094611	203	LR162042	200	MTC8294	93
LR029301G	166	LR051615G	166	LR094642	203	LR162042G	200	MTC9967	104
LR029301HD	165	LR051616PY	169	LR097165G	209	LR162044	200	MUC1488	105
LR029302G	166	LR051621PY	169	LR098141G	176	LR162044G	200	MUC1488G	105
LR029302HD	165	LR051622G	166	LR108980COG	202	LR162045	200	MUC1488LCS	105
LR029303G	166	LR051622GK	166	LR108984G	172	LR162045G	200	MUC1520	105
LR029303GK	166	LR051623G	166	LR115005G	201	LR162046	200	MUC1520LCS	105
LR029303HD	165	LR051623GK	166	LR116116G	176	LR162046G	200	MUC2344	17
LR029303K	166	LR051771	278	LR116119G	176	LR162047	200	MUC3986SS	231
LR029304G	166	LR052028LR	18	LR116911G	201	LR162047G	200	MUC3987SS	231
LR029304GK	166	LR052059	251	LR116914G	201	LR162048	200	MUC3990	17
LR029304HD	165	LR052652	254	LR117128	211	LR162048G	200	MUC4122ABE	113
LR029304K	166	LR052653G	254	LR117128C	211	LR164029	200	MUC8414	104
LR029305G	166	LR052756	214	LR117128P	211	LR164029G	200	MUC8730	229
LR029305GK	166	LR053845	53	LR122689	200	LR164821	200	MUC8731	229
LR029305HD	165	LR054831PY	169	LR122689G	200	LR164821G	200	MUC9154	229
LR029305K	166	LR055301BLUE	205	LR132811G	201	LR165293	200	MUC9155	229
LR029306G	166	LR055301RED	205	LR134644	200	LR166213	207	MUC9220GALV	229
LR029306GK	166	LR055323	17	LR134644G	200	LR170345X	204	MWC1743	111
LR029306HD	165	LR055330	17	LR134692	200	LR173842B	55	MWC3136	264
LR029306K	166	LR055331	17	LR134692DT	146	LR173842BX	55	MWC3136X	263
LR029310	232	LR055332	17	LR134692G	200	LR173842GX	55	MWC3302	104
LR029311	232	LR055333	17	LR134693	200	LR173842X	55	MWC3303	104
LR030047HD	165	LR055334	17	LR134693DT	146	LR174897PYB	169	MWC4535	104
LR030048HD	165	LR055339	17	LR134693G	200	LR179201	207	MWC4840	234
LR031310PY	169	LR055340	17	LR134694	200	LR181438G	254	MWC4841	234
LR031843G	199	LR056964PY	169	LR134694DT	146	LR19977G	166	MWC5465LCS	105
LR031844G	199	LR058447	284	LR134694G	200	LR19978G	166	MWC5599LCS	105
LR031845G	199	LR059122G	199	LR134695	200	LRCEAHUEG	338	MWC5670LCS	104
LR031846G	199	LR059125	278	LR134695DT	146	LRCORPMUG14	338	MWC6702	234
LR031924	59	LR059126	278	LR134695G	200	LRDCA3EVOQ	338	MWC9060	234
LR031947	200	LR059127	278	LR134696	200	LRDCA494	338	MWC9061	234
LR031947KIT	198	LR059128	278	LR134696DT	146	LRDCA5EVOQ	338	MWC9084	234
LR032305LR	308	LR059129	278	LR134696G	200	LRLO087ENG	328	MWC9085	234
LR032306LR	308	LR061295LR	84	LR134697	200	LRLO178ENGLR	328	MWC9134	264
LR032567	176	LR061385	200	LR134697G	200	LRT-12-058	266	MWC9134BLUE	264
LR032954	200	LR061388G	199	LR134700	200	LRT-12-093	267	MWC9843LCS	104
LR032954G	200	LR062058S	11	LR134700DT	146	LRT-12-094	267	MWC9844LCS	104
LR033238	165	LR063718G	166	LR134700G	200	LRT-12-158	266	MWC9918PMAX	263
LR033302G	199	LR063719G	166	LR134709	200	LRT-60-003	272	MXC1800	264
LR033303G	199	LR068126B	55	LR134709G	200	LRT-60-004	272	MXC1800X	263
LR033981	111	LR068126BX	55	LR134882	200	LRT-64-003	272	MXC1992LCS	111
LR034392PY	169	LR068126GX	55	LR134882G	200	LTP3001	330	MXC2063	237
LR038128	203	LR068126X	55	LR138646	200	LTP3001USB	330	MXC2064	237
LR038148G	172	LR070497	84, 87	LR138646G	200	LTP3002	330	MXC3257LCS	104
LR038341	203	LR070497G	84, 87	LR139969	200	LTP3002USB	330	MXC3918	237
LR038617	278	LR070934B	176	LR139969DT	146	LTP3003	330	MXC3919	237
LR038751	206	LR070942B	176	LR139969G	200	LTP3003USB	330	MXC5495	105
LR038934G	199	LR071295	84, 87	LR140034G	172	LTP3004	330	MXC5587	17
LR039149	212	LR072016G	199	LR141734	200	LTP3004USB	330	MXC6412	17
LR039638LUCAS	218	LR072258G	254	LR141734G	200	LTP3005	330	MXC6413	17
LR039783	214	LR072537	172	LR147981	200	LTP3005USB	330	MXC6828	237
LR039935G	199	LR072855	203	LR147981G	200	LTP3006	330	MXC8335	237
LR041777C	172	LR072972	211	LR148353	200	LTP3006USB	330	N78	175
LR041777G	172	LR072976XS	165	LR148353DT	146	LTP3007	330	NAD10040HD	152
LR042728	232	LR072977XS	165	LR148353G	200	LTP3007USB	330	NAD101490HD	152
LR044034	172	LR073340HD	165	LR148836PYB	169	LTP3008	330	NAV007	325
LR044278	240	LR073366HD	165, 169	LR156926	200	LTP3008USB	330	NAV008	325
LR044280	240	LR073366PF	168	LR156926G	200	LTP3010	330	NAV009	325
LR044451LEDB	74	LR073366PY	170	LR157174	200	LTP3015	330	NAV013	325
LR044451LEDR	74	LR073366PYB	169	LR157174G	200	LTP3015USB	330	NAV014	326
LR044451LEDW	74	LR073367G	166	LR160069	200	LTP3016	330	NAV016	326
LR044681B	176	LR073367GK	166	LR160069G	200	LTP3016USB	330	NAV018	324
LR045096LR	98	LR073367HD	165	LR160435	200	LTP3017	330	NAV020	326
LR045271	104	LR073367K	166	LR160435G	200	LTP3017USB	330	NAV021	324
LR045272	104	LR073369G	166	LR160436G	200	LUCASCAT	342	NAV022	324
LR045409X	263	LR073369GK	166	LR160437	200	LX100	118	NAV023	324
LR045519REPAIRKT	208	LR073369HD	165	LR160437G	200	MJUM030BKA	339	NAV024	325
LR045926X	263	LR073369K	166	LR160438	200	MRC2178X	263	NAV025	325
LR047630	203	LR073537	214	LR160438G	200	MRC316	14	NAV026	325
LR047798LED	74	LR073538	214	LR160444	200	MRC316P	14	NAV027	324
LR048187LED	74	LR073539	214	LR160444G	200	MRC3519	113	NAV029	326
LR048187LEDCL	74	LR075816	232	LR160458	200	MRC3657	105	NAV032	324
LR048187LEDSDM	74	LR075993G	166	LR160458G	200	MRC6980	105	NAV034	326
LR048188LED	74	LR075993GK	166	LR160459	200	MRC6980CG	105	NAV036	324
LR048188LEDSDM	74	LR075993HD	165	LR160459G	200	MRC6982	105	NAV040	324
LR048189LED	74	LR075993K	166	LR160460	200	MRC6982CG	105	NAV1002	324
LR048189LEDSDM	74	LR075993NB	166	LR160460G	200	MRC6982H	105	NAV2002	324
LR048200LED	74	LR075993PY	166	LR160486	200	MRC6985	105	NGC103740/810	202
LR048200LEDCL	74	LR075995G	166	LR160486G	200	MRC6985CG	105	NGC103740/810RED	202
LR048200LEDSDM	74	LR075995GK	166	LR160504	200	MRC7166	237	NGC103LUCAS	222
LR048201	74	LR075995HD	165	LR160504G	200	MTC2640A	285	NGC500370/410	202
LR048201LED	74	LR075995K	166	LR160511	200	MTC3000SS	231	NH605041LX	263
LR048201LEDCL	74	LR075995NB	166	LR160511G	200	MTC3001SS	231	NRC2051	82
LR048201LEDSDM	74	LR075995PY	166	LR160532	200	MTC3181	105	NRC236	236
LR048202LED	74	LR075996HD	165	LR160532G	200	MTC3181CG	105	NRC236E	236
LR048202LEDSDM	74	LR077439LUCAS	223	LR160540	200	MTC3481GALV	229	NRC4171GALV	233
LR051107	278	LR078545	54	LR160540G	200	MTC3482GALV	229	NRC4218SS	158
LR051108	278	LR078650	172	LR160580	200	MTC4290GALV	228	NRC4219SS	158
LR051311	214	LR079515B	176	LR160580G	200	MTC4503	240	NRC4356	226
LR051320	214	LR079891F	334	LR161895G	201	MTC5083	16	NRC4402GIRLING	224
LR051585PF	168	LR082331GX	263	LR161896G	201	MTC5084	16	NRC4514PY	170
LR051585PY	170	LR083283G	209	LR161898G	199	MTC5217	16	NRC4514PYYELLOW	170
LR051585PYB	169	LR086417G	54	LR161899G	199	MTC5382	236	NRC4642G	226
LR051592G	166	LR087082B	176	LR161901G	201	MTC5382G	236	NRC4642G-M	227

Part Number	Page Number	Part Number	Page Number	Part Number	Page Number	Part Number	Page Number	Part Number	Page Number
NRC4717	237	QRF100870LUCAS	223	RKB500240G	179	RTC4236	176	SFP500120G	200
NRC5593PY	170	RBJ102920/930BJ	196	RNF100090PY	170	RTC430LUCAS	221	SFP500130	200
NRC5593PY-YELLOW	170	RBJ500222GK	166	RNF100090YELLOW	170	RTC4442GIRLING	224	SFP500130G	200
NRC6372GALV	167	RBJ500222GK	166	ROA000022PY	169	RTC4472GIRLING	224	SFP500150	200
NRC6432SS	158	RBJ500232G	166	ROA100040PYB	169	RTC4483GIRLING	224	SFP500150G	200
NRC6433SS	158	RBJ500232GK	166	ROA100050PY	170	RTC4484	176	SFP500160	200
NRC6436SS	158	RBJ500680/690BJ	196	RPD500260G	176	RTC4484GIRLING	224	SFP500160G	200
NRC6920	128	RBJ500680/690BJG	196	RPD500760G	176	RTC4517CL	237	SFP500180	200
NRC7415B	55	RBJ500840NB	166	RPD500940G	176	RTC4588LUCAS	219	SFP500180G	200
NRC7842SS	158	RBJ500850NB	166	RPD500940M	176	RTC4589LUCAS	219	SFP500190	200
NRC8254LR	50	RBJ500920LEM	166	RPM100070B	175	RTC4590LUCAS	219	SFP500190G	200
NRC8888SS	158	RBK500210M	165	RPM100080B	175	RTC4591LUCAS	219	SFP500200	200
NRC8889SS	158	RBL01175SS	42	RB1000370	54	RTC4615	77	SFP500200G	200
NRC9137SS	158	RBL0334SS/A	43	RRB100510	54	RTC4615C	77	SFP500210	200
NRC9211	11	RBL033PAD	43	RRB100510SET	54	RTC4615CW	77	SFP500210G	200
NRC9457GIRLING	224	RBL0526SSS	44-45	RRB500090	54	RTC4615K	77	SFP500220	200
NRC9458GIRLING	224	RBL0927SSS	43	RRC2970	18	RTC4615KW	77	SFS000051	200
NRC9474GALV	229	RBL0927SSSLHD	43	RRC2971	18	RTC4615W	77	SFS500012	200
NRC9700GALV	167-168	RBL1087SSS	43	RRC501470MCM	50	RTC4685	17	SFS500012KIT	198
NRC9836SS	158	RBL1224SNS	43	RRC503400MNH	50	RTC4769	11	SHU000040SS	230
NTC1149SS	158	RBL122PAD	43	RRC503430MUW	53	RTC4820X	263	SHU000050SS	230
NTC1150SS	158	RBL1383SSS	44	RRC505360MNH LR	50	RTC5225HD	152	SHU100340SS	230
NTC1322SS	158	RBL1387PAD	43	RRC505370MNH LR	50	RTC5232HD	152	SJB21EUX2	71
NTC1665SS	158	RBL1387SSS	43	RRC5513LCS	105	RTC5294LUCAS	219	SJB36F	71
NTC1666SS	158	RBL1487SSS	42	RRC5513LOY	105	RTC5295LUCAS	219	SJB36S	71
NTC1772PY	170	RBL1506SSS	44	RRC5514LOY	105	RTC5628LUCAS	222	SJBHARN	71
NTC1772PY-YELLOW	170	RBL150FFK	44	RRC5515LOY	105	RTC5903GIRLING	224	SJBLINX	71
NTC1773PB	169	RBL1536SSS	43	RRC6681	11	RTC5940GIRLING	224	SMN000060GIRLING	199, 224
NTC1773PY	170	RBL1727PAD	42	RRC7896LOY	105	RTC5989LUCAS	219	STC1066	234
NTC1773PY-YELLOW	170	RBL1727SSS	42	RRC7897LOY	105	RTC5990LUCAS	219	STC1066C	234
NTC1800SS	158	RBL1837SSS	42	RRC8443	16	RTC6066SH	207	STC1135	237
NTC2726SS	158	RBL1857SSS	42	RRC8572LOY	105	RTC6247	232, 236	STC1136	237
NTC2832SS	158	RBL1887SSS	43	RRD000100LR	54	RTC6248NG	232, 236	STC1172B	206
NTC4221SS	158	RBL188PAD	43	RRD000110LR	54	RTC6283	232	STC1184K	202
NTC4426SS	158	RBL1907SSS	42	RRD000120LR	54	RTC6284G	232	STC1188	74
NTC4614SS	158	RBL2057SSS	42	RRD000130LR	54	RTC6317	237	STC1270GIRLING	224
NTC5193PM	53	RBL2137SSS	43	RRD100520	55	RTC6318	237	STC1424	232
NTC6781PY	170	RBL2303SSS	44	RRD100530	55	RTC6352G	232	STC1427H	207
NTC6781PY-YELLOW	170	RBL2303SSSBLACK	44	RRD100540	55	RTC6353	232	STC1435LUCAS	223
NTC6791SS	158	RBL2367SSS	43	RRD100550	55	RTC6354	232	STC1694/5/6/7	207
NTC6828PY	170	RBL2427SSS	42	RRD100560	55	RTC6401VALR	257	STC1774VALR	257
NTC6828PY-YELLOW	170	RBL2437SSS	42	RRD100570	55	RTC6551	202	STC1774VTLR	257
NTC6860PY	170	RBL2447SSS	42	RRD100580	55	RTC6551LUCAS	222	STC1853	202
NTC6860PY-YELLOW	170	RBL2477SSS	44	RRD100590	55	RTC6551RED	202	STC1854G	232
NTC7307PY	170	RBL2497SSS	44	RRD100600	55	RTC6621LUCAS	222	STC1855G	232
NTC7307PY-YELLOW	170	RBL2507SSS	42	RRD100610	55	RTC6732/3/4/5	207	STC201S	198
NTC7394PY	170	RBL2557SSS	42	RRD500010GX	55	RTC6820	17	STC250	210
NTC7394PY-YELLOW	170	RBL2587SSS	44	RRD500010X	55	RTC6821	17	STC2802B	206
NTC7829	58	RBL2607SSS	44	RRD500560B	55	RTC6870VTLR	257	STC2813	234
NTC7829HD	58	RBL2997SSS	43	RRD500560BX	55	RTC8831	82	STC2814	234
NTC8780G	199	RBL299PAD	43	RRD500560GB	55	RTC8860AA	13	STC2815	234
NY606041LX	263	RBL3017SSS	43	RRD500560GBX	55	RTC8891AA	82	STC2816	234
NZ606041LX	263	RBL301PAD	43	RRD500560GX	55	RTC8891AAB	82	STC2828VTLR	257
OMELRCP1	179	RBL3087SSS	47	RRD500560X	55	RTC8922	64	STC2829GIRLING	224
OMELRCP2	179	RBL3097SSS	47	RJ000030LR	54	RTC8969	13	STC2830B	175
OMELRCP3	179	RBL3107SSS	47	RJ100120	54	RTC9479	17	STC2831GIRLING	224
PDA500300LR	254	RBL3167SSS	47	RRL2290FRS	47	RTC9503AA	14	STC3018SS	77
PEB102240LG	209	RBL3177SSS	47	RRL2290LRS	47	RTC9535	54	STC3135	210
PEB102420LG	209	RBM100172HD	165	RRL2290NRS	47	RTC9562	17	STC3261	210
PEB102510LG	209	RBM100223HD	165	RRL2290SRS	47	RTC9837C	328	STC3410	55
PEB500090G	209	RBM500190HD	165	RRL2320FRS	47	RTC9839C	328	STC3411	55
PEH101080SCREW	204	RBX101240PY	170	RRL2320LRS	47	RTC9840CC	328	STC3412	55
PEM500040G	209	RBX101240YELLOW	170	RRL2320NRS	47	RTC9841CE	328	STC3413	55
PHB000180HOSE	204	RBX101340PY	170	RRL2320SRS	47	RTC9842CE	328	STC3414	55
POSTER SET	342	RBX101340YELLOW	170	RRL2450FRS	47	RTC9846CH	328	STC3415	55
PRC1330SS	334	RBX101680PY	170	RRL2450LRS	47	RTC9863CE	328	STC3416	55
PRC2670LUCAS	218	RBX101680YELLOW	170	RRL2450NRS	47	RTC9947CF	328	STC3418	55
PRC2734LUCAS	218	RBX101690PY	170	RRL2450SRS	47	RTC9970CE	328	STC3419	55
PRC2735LUCAS	218	RBX101690YELLOW	170	RRL3156SSS	47	RUC105200HD	164	STC3420	55
PRC2911LUCAS	220-221	RBX101730PY	170	RRL315RR-RC-XRA	47	RVU000022PY	169	STC3421	55
PRC2949	237	RBX101730YELLOW	170	RRL315RR-RC-XRB	47	RVU500011PY	169	STC3422	55
PRC3430LUCAS	221	RBX101780PY	170	RRY500180SS	196	SACS001	44	STC3423	55
PRC3432LUCAS	221	RBX101780YELLOW	170	RSC100040B	175	SDB000201G	199	STC3424	55
PRC3875LUCAS	220-221	RBX101790PY	170	RSC100050B	175	SDB000211G	199	STC3425	55
PRC3900LUCAS	220	RBX101790YELLOW	170	RT06A	102	SDB000380G	199	STC3426	55
PRC4826LUCAS	222	RDB100080PY	170	RT11A	102	SDB000470G	199	STC3427	55
PRC5072LUCAS	220-221	RDB100080YELLOW	170	RTC210LUCAS	219	SDB000604G	199	STC3428	55
PRC5425LUCAS	221	REB101740	179	RTC2408H	207	SDB000614G	199	STC3429	55
PRC5436LUCAS	220	RGD000312HD	165	RTC3022LUCAS	223	SDB000624G	199	STC3435	254
PRC5610LUCAS	220	RGD100682HD	165	RTC3095	121	SDB000636G	199	STC3435S	254
PRC6387LUCAS	220	RGD500140HD	165	RTC3254	262	SDB000646G	199	STC3580	55
PRC7370LUCAS	220	RGX100960K	169	RTC3278LUCAS	222	SDB100830G	199	STC3581	55
PRC7994C	77	RGX100970PY	170	RTC3278RED	202	SDB101070G	199	STC3582	55
PRC7994KW	77	RGX100970YELLOW	170	RTC3347	262	SDB500182G	199	STC3583	55
PRC7994W	77	RGX101000PY	170	RTC3353GIRLING	224	SDS102	318	STC3584	55
PRC8230LUCAS	218	RGX101000YELLOW	170	RTC3386GIRLING	224	SDS200	318	STC3585	55
PRC8238	64	RGX101010PY	170	RTC3471LUCAS	222	SE105161L	74	STC3586	55
PRC8593LUCAS	223	RGX101010YELLOW	170	RTC3472LUCAS	222	SERVICESTICKERPK	245	STC3587	55
PRC8876LED	74	RGX101020PY	170	RTC3534	197	SFC500080	200	STC3588	55
PRC8876LUCAS	220	RGX101020YELLOW	170	RTC3534G	197	SFC500080G	200	STC3589	55
PRC8907LUCAS	223	RGX101440PY	170	RTC3537	197	SFP000250	200	STC3671GIRLING	224
PRC9858LUCAS	222	RGX101440YELLOW	170	RTC3537G	197	SFP000250G	200	STC3671M	176
PSD103470BRG	211	RGX500060PY	169	RTC3612LUCAS	222	SFP000260	200	STC3672GIRLING	224
PYP10008BLUE	205	RHF500110A	167	RTC3633LED	73, 80	SFP000260G	200	STC3703B	175
PYP10008RED	205	RK12A	138	RTC4041VALR	257	SFP000280	200	STC3703GIRLING	224
QEM500020PY	170	RK9A	138	RTC4230GIRLING	224	SFP000280G	200	STC3704B	175
QEM500020YELLOW	170	RKB101200	179	RTC4232GIRLING	224	SFPI00360	200	STC3704GIRLING	224
QFK500010HD	165	RKB101460	179	RTC4234	176	SFPI00360G	200	STC3758G	209
QFK500020HD	165	RKB500082G	179	RTC4235	176	SFP500120	200		



Part Number	Page Number	Part Number	Page Number	Part Number	Page Number	Part Number	Page Number	Part Number	Page Number
STC3766B	175	STC7978ABLR	17	VPLCP0209	30	VPLGT0073	88	VUB501390	15
STC3766GIRLING	224	STC8056LR	13	VPLCP0210LR	30	VPLGT0082	87	VUB501920	15
STC3767GIRLING	224	STC8057ACL	35	VPLCP0277LR	17	VPLJS0685	96	VUB501980	12
STC3769B	175	STC8130AB	30, 32	VPLCS0268LR	94	VPLKV0134LR	334	VUB503650	299
STC3769GIRLING	224	STC8138AB	122	VPLCS0269	102	VPLMS0083LR	98	VUB503660	32
STC3770GIRLING	224	STC8156AA	164	VPLCS0273LR	94	VPLMS0085PVJLR	101	VUB503880MMM	299, 301, 303
STC3771GIRLING	224	STC8156AAPY	164	VPLCS0274LR	94	VPLMS0085SVALR	101	VUB503940	17
STC3772GIRLING	224	STC8354	233	VPLCS0278LR	98	VPLMS0087PVJ	101	VUB503960	87
STC3822VALR	257	STC8355	233	VPLCS0279LR	94	VPLMS0087SVA	101	VUB504110	13
STC3828VALR	257	STC8356	233	VPLCS0280LR	98	VPLMS0680LR	98	VUH000020	88
STC3939GIRLING	224	STC8363	211	VPLCS0281LR	98	VPLMS0681LR	98	VYK000010	249
STC3941B	175	STC8414	90	VPLCS0291PVJLR	101	VPLMS0682LR	98	WCE000030SS	158
STC3941GIRLING	224	STC8480LR	64	VPLCS0291SVALR	101	VPLMT0006	88	WCE000040SS	158
STC4104LUCAS	220	STC8505AA	32	VPLCS0292PVJLR	101	VPLPP0060LR	12	WCE104231SS	158
STC4235VTLR	257	STC8524	91	VPLCS0292SVALR	101	VPLPP0061LR	12	WDE100590SS	158
STC4286	83, 85	STC8529AA	122	VPLCS0293PVJLR	101	VPLPS0684LR	98	WDV100260SS	158
STC4378G	209	STC8535	17	VPLCS0293SVALR	101	VPLRP0270LR	30	WDV100270SS	158
STC439LUCAS	220-221	STC8536	17	VPLCS0300	90	VPLRP0283LR	17	WDV500020SS	158
STC4404	262	STC8587	203	VPLCS0588LR	102	VPLRP0347LR	30	XBD100760W	73
STC4596VTLR	257	STC8604	233	VPLCT0140LR	84	VPLRP0357LR	17	XBD100770W	73
STC4597VALR	257	STC8605	233	VPLCT0147	84	VPLRS0332AAML	98	XDISC	149
STC4600	262	STC8606	233	VPLCT0148	84	VPLRS0332PVJLR	98	XFC100540LED	73
STC4629	93	STC8607	233	VPLCT0148LR	84	VPLRS0333PVJLR	98	XFC100550CH	281, 297
STC4629LR	93	STC8608	233	VPLCT0182	85	VPLRS0335PVJLR	101	XFC100550LEDG	74
STC4637	74	STC8609	233	VPLCT0244	85	VPLRS0373AAML	94	XFC500040LED	73
STC4672LR	255	STC8610	233	VPLDC0004NERLR	257	VPLRS0373PVJLR	94	XFC500050LED	73
STC4723N	206	STC8648	233	VPLDP0067	28	VPLRS0386LR	98	XFD100100LED	74
STC4757	203	STC8649	233	VPLDP0068	28	VPLRT0171G	84	XGB000073LED	301, 303, 309
STC4793LUCAS	220	STC8652	233	VPLDP0532	17	VPLRT0171LR	84	XGB100310L	281
STC483G	209	STC8653	233	VPLDS0147	96	VPLRT0175G	84	XPAD	149
STC4861R	249	STC8655LUCAS	220-221	VPLDS0147LR	98	VPLRT0175LR	84	XPADSERIES	149
STC4862	251	STC8693	233	VPLDS0241LR	98	VPLRW0153G	58	XPB101290LUCAS	220-221
STC4862G	249	STC8694	233	VPLDS0674	96	VPLSP0016LR	17	YGD000271	203
STC4863	251	STC8695	233	VPLDS0674LR	98	VPLSP0040	32	YGD100860	203
STC4863G	249	STC8843AA	54	VPLDS0675	96	VPLSS0016LR	95	YGD500100	203
STC500100GIRLING	212	STC8972	254	VPLDS0675LR	98	VPLSS0026PVJ	101	YMZ101030	86
STC50026	14	STC9021CC	328	VPLDS0676	96	VPLSS0042	302	YUF101490LUCAS	221
STC50027	14	STC9049CA	328	VPLDS0676LR	98	VPLSS0043	95	YWC000840	88
STC50032	30	STC9124	202	VPLDS0677	96	VPLSS0138LR	102	YWJ101500	83
STC50052AA	94	STC9124LUCAS	222	VPLDS0677LR	98	VPLSS0679LR	98	YWJ500150	88
STC50053AA	94	STC9155LR	255	VPLDS0686LR	98	VPLST0014	88	YWJ500201	85
STC50063LR	45	STC9157	249	VPLDT0086LR	83	VPLTP0064	15	YWJ500450	88
STC50064	14	STC9158	249	VPLDV0001LR	278	VPLVP0065	17	YWJ500460	88
STC50080	54	STC958H	207	VPLDV0003LR	278	VPLVP0066	17	YWK10003L	202
STC50081	85	STICKER-COMPASS	56	VPLDW0095PVT	53	VPLVP0069	17	YWK10005	202
STC50134	45	STICKER-TRACK	56	VPLEP0379LR	17	VPLVP0070	17	YWT10002L	85-86, 88
STC50181LR	85	STICKER-UNION-F	56	VPLEP0387LR	21	VPLVP0184	32		
STC50221	17	STICKER-UNION-FG	56	VPLEP0388LR	17	VPLVS0070PVJ	101		
STC50222	17	STICKER-XS	56	VPLEP0389LR	17	VPLVS0071PVJ	101		
STC50243	64	SW002	318	VPLEP0390LR	17	VPLVS0072PVJ	101		
STC50269AA	29	SYP500090X	263	VPLEP0433LR	28	VPLVS0077PVJ	101		
STC50269AAB	29	T2QP112	40	VPLEP0434LR	28	VPLVS0090LR	95		
STC50289AB	84	T2QP162	40	VPLEP0435LR	128	VPLVS0091	95		
STC50301	29	TA45	123	VPLEP0436LR	22	VPLVS0175LR	102		
STC50319	84	TA62A	123	VPLEP0447LR	281	VPLVT0065	87		
STC50323	90	TAG000230CWP	212	VPLEP0517LR	281	VPLVT0069	87		
STC50389	85	TAY100050L	197	VPLEP0542LR	35	VPLVT0078	87		
STC50402AALR	98	TAY100060L	197	VPLER0177LR	35	VPLVT0245G	88		
STC50417	45	TBB000270E	214	VPLER0178LR	35	VPLWP0165	17		
STC50434	93	TLOARB	126	VPLER0181LR	35	VPLWP0166	17		
STC50435	93	TOT100000	212	VPLER0196LR	45	VPLWP0167	17		
STC50459	86	TPBAG	126	VPLES0553LR	98	VPLWS0190LR	98		
STC50479	90	TPMK	126	VPLES0565LR	93	VPLWS0223LR	95		
STC50519	252	TRAYBACK STICKER	342	VPLES0566LR	93	VPLWS0224LR	95		
STC50519-20L	252	TRC102900LR	212	VPLES0570LR	93	VPLWS0225	95		
STC50519LR	255	TRC103160E	212	VPLES0572PVJLR	286	VPLWS0225LR	95		
STC50529	254	TRC103260E	212	VPLES0665LR	98	VPLWS0226LR	95		
STC50529LR	254	TRC103350E	212	VPLES0666LR	98	VPLWS0228PVJ	101		
STC50530	254	TREDPROBB	126	VPLES0667LR	98	VPLWS0228SVALR	101		
STC50530-20L	254	TREDPROMGO	126	VPLES0668LR	98	VPLWS0229SVALR	101		
STC50531	251	TVK000180E	214	VPLEW0143LR	56	VPLWS0230SVA	101		
STC50531LR	249	TYK500010	251	VPLFR0091	45	VPLWS0374PVJLR	98		
STC50544LR	254	TYK500010-20L	251	VPLFS0234LR	98	VPLWS0375PVJLR	98		
STC50550	262	TYK500010-4L	251	VPLFS0244LR	93	VPLWS0589LR	102		
STC50552	262	TYK500010G	249	VPLFS0245PVJ	98	VPLWS0660LR	98		
STC53075AALR	17	TYK500030	251	VPLFS0683LR	98	VPLWT0114	88		
STC53076AALR	17	TYK500030-4L	251	VPLFT0001	86	VPLWT0159	87		
STC53157	13	TYK500050	251	VPLFT0077	86	VPLYS0413LR	98		
STC53158	13	TYK500050-208L	251	VPLFT0105	86	VPLYS0414LR	98		
STC53161	13	TYK500050-20L	251	VPLFT0106	86	VPLZR0187LR	35		
STC53193	14	TYK500050-4L	251	VPLFT0118	86	VPLZS0490LR	98		
STC53194	14	TYK500050G	249	VPLFT0119	86	VPLZS0491LR	98		
STC542	232	TYL100030	264	VPLFT0120	86	VPLZS0529LR	314		
STC543	232	URB500060	211	VPLGP0109	17	VPLZS0701LR	98		
STC618PY	170	URB500060G	211	VPLGP0110	17	VTD500010	30		
STC618PY-YELLOW	170	UTP1725	210	VPLGP0111LR	17	VTD500020	30		
STC637G	209	UYH500020X	263	VPLGP0226	32	VUB000720	87		
STC639G	209	VEP501730HFULR	257	VPLGP0248LR	32	VUB000730	87		
STC7555	90	VEP501740HFYLR	257	VPLGP0249LR	32	VUB001070LR	15		
STC7623LR	54	VM80010036	175	VPLGP0366LR	32	VUB001230	32		
STC7631	29	VM80010037	175	VPLGP0367LR	32	VUB001300	32		
STC7631MT	29	VPLAB0025LMLLR	301, 303	VPLGS0149LR	98	VUB001310	32		
STC7632	29	VPLAP0017	17	VPLGS0153LR	102	VUB001320LR	17		
STC7632MT	29	VPLAP0035	30	VPLGS0154PVJLR	101	VUB001330LR	17		
STC7643	64	VPLAR0001	35	VPLGS0154SVALR	101	VUB500520	14		
STC7703	17	VPLAS0015LR	94	VPLGS0155PVJLR	101	VUB500900	334		
STC7889LR	56	VPLAS0130PVJLR	101	VPLGS0260	95	VUB501170LR	90		
STC793/4/5/6	207	VPLAS0198LR	98	VPLGS0263LR	95	VUB501200	14		
STC7939AB	90	VPLAT0011	85	VPLGS0444PVJLR	98	VUB501380	14		



<i>Part Number</i>	<i>Page Number</i>	<i>Part Number</i>	<i>Page Number</i>	<i>Part Number</i>	<i>Page Number</i>
4-Corner air suspension	183	Brake reservoir tanks	200, 212	Deployable side steps	31
A-Bars	12	Brake shield bracket	230	Detent repair springclip	212
Accessory mount clamps	44	Brake shoes, XD	200	Detroit lockers	121
Acoustic mat systems	99	Brake tools	268	Diesel system cleaner	252
Actuator repair cog	202	Breather hose kits	153	Diff breather kit	119
AdBlue	254	Breather kit	119	Diff coupling shaft	212
Adjustable ball joint	167	Breathers	204	Diff cover	120
Adjustable control arms	165	Brembo brake discs	201	Diff guards	23
Adjustable suspension lift rod kit	168	Bridging ladders	126	Diff lock lever	121
Air cleaner hose kit	204	Britpart clothing	342	Diff overhaul kits	214
Air compressors, diff lockers	118-119	Britpart Expedition roof racks	34	Diff repair pans	212
Air compressors, tyres	58-59	Britpart merchandise	341	DIN dashboard mount	285
Air conditioning fans	154	Bulbs	78	Dinitrol products	260
Air conditioning kits	283	Bulk filters	204	Dirt D-fenders	20
Air filters, K&N	149	Bulk wheel nuts	55	Dislocation cones	168
Air filters, performance	151-152	Bulk workshop consumables	263	Distributor cap	202
Air Lift	178	Bulkhead	232-235	Dog guards	90-92
Air spring conversion kits	184	Bulkhead bars	114	Dog ramp	91
Air springs	179	Bulkhead front assembly	238	DOIP SST	192
Air suspension compressors	172	Bump stops	168	Door card fixing kit	111
Air tank	119	Bumper fitting kits	11	Door handle covers	299, 301
Air-con compressor oil	255	Bumper, bodywork	238	Door handle repair kit	240
Air-con evaporator core	210	Bumper, LED	72	Door handles	279
Alcon brake kits	145	Bumperettes	11, 18	Door hinges	239
Alloy wheel cap	50	Bumpers	11, 18	Door lock button	238
Alloy wheels	50	Bumpers, winch	135-136	Door lock kits	240
Alternator upgrades	202	BungeeClic load securing system	46	Door seal kits	238
Aluminium tanks	150	Bush sets	171	Door stays	115
Anti-corrosion epoxy primer	259	Bush tools	172	Door threshers	286
Anti-freeze	254	Bushes	164, 168-171, 275	Doors	232-235
Anti-rattle jack clamps	125	Calibration tools	272	Double cardan repair kits	212
Anti-roll bars	164	Cambuckle tie downs	102	Double S exhausts	156-157
Anti-squeal shims	198	Camera, rear surround	18	Downpipes	159
ARB diff lockers	118-120	Camping bags & cases	322-323	DPF cleaner	254
ARB hydraulic jack	125	Camping table	319	Dr. Tranny Instant Shudder Fixx	254
ARB lights	70-72	Camshaft	204	Drive flange bolt caps	54, 164
ARB Linx	118	Car covers	21	Drive flanges	164
ARB merchandise	320	Carburettor float	208	Driving lights	64
ARB roof racks	41	Carburettors, Weber	155	DTEC brake pads	146
Armrests	109-111	Cargo barriers	90-92	Dual battery management system	141
Ashcroft Transmissions	121	Cargo organisers	322	Dust caps	58
Auto transmission lever parts	212	Cargo tie down point	102	Duxback	255
Automatic transmission conversion kit	215, 246	Carpet kits	106	Dynamat Xtreme	294
Automatic transmission service kits	246	Carpet mats	98	Dynamic response tools	268
Avdel plug	207	Castor corrected swivel housings	164	Earth lead	202
Awning brackets	316	Castor correction bushes	169	EAS override module	184
Awning replacement parts	316	Castor correction wedges	180	EBC brake discs	146
Awnings	315	Castrol Classic oils & greases	253	EBC brake pads	147-148
Ball joint	167	Castrol Classic Oils merchandise	337	EGR blanking kits	150-151
Ball joint repair kits	196	Cataclean	253	EGR valve & gaskets	204
Batteries	140-141	Cellular Dynamic shock absorbers	174	Electric side steps	31
Batteries, key fob	202	Cera-Tec lubricant	198	Electric windows	282
Battery charger	140	Chain cover	115	Electronic distributors	202
Battery charger & support units	194	Chair, camping	319	Electronic fan conversion kits	154
Battery isolator switch	138	Chassis	226-227	Emergency equipment	122-123
Battery management system	141	Chassis components	232-240	Emergency hammer	122
Battery-Guard	140	Chequer plate	10	Emergency puncture repair sealant	122
Beadlock wheels	50	Clear lights	73	Engine bay enhancements	205
Bearing grease	254	Clutch cylinders	212	Engine breather oil catch tank	205
Bearings, propshaft	212	Clutch hoses	212	Engine oil pan	204
Big bore exhaust tailpipes	158	Clutch pedal assist kit	212	Engine oils	249-250
Bike racks	45-47	Clutch release fork kit	212	Engines	206
Bilstein shock absorbers	176	Clutch reservoir tanks	200, 212	Epoxy primer	259
Black wheel nuts	55	Clutch tools	272	Evans waterless coolants	256
Blanking kits	150-151	Clutches	211	Exhaust clamps	158
Bleed screws	205, 208	Coil set packers	179	Exhaust fitting kits	158
Blind spot mirror	16	Comfort connectors	141	Exhaust paste & putty	261
Blindo wheels	51	Compressors	118-119	Exhausts components	158
Body components	232-240	Compressors, air suspension	172	Expansion bottle cap	205
Body repair consumables	261	Con rod bearing sets	207	Expedition boxes	321
Boge shock absorbers	175	Con rod parts	204	Extended fuel tanks	123
Bolt kits	297	Connecting spindle rods	165	Extended seat rails	114
Bolts	196	Connector assembly fuel blocks	207	Exterior lights	64-72, 79
Bonnet hinges	280	Cool bag	314	Fairleads	136
Bonnet insulation pad	240	Coolant hoses	153	Fan conversion kits	154
Books	329	Coolants	252, 254	Fasteners & fixings	263
Boot organiser	102	Cooling system pressure test kit	269	FBH controller	302, 305
Boot protection	92-98	Corbeau seats	107	Filler plugs	205
Bottle jack	57	Cordless tyre inflator	57	Filter guards	150
Brake caliper pin kit	198	Coupling control unit	214	Filters, bulk	204
Brake caliper pistons	198	Coupling filter	213	Fire extinguishers	122
Brake cleaner	254	Covers, spare wheel	56	Fire pit	326
Brake discs	144-145	Crankshaft tools	268	First aid kits	122
Brake discs, EBC	146	Crossmembers	233-236	Flange bolt kits	186
Brake discs, XS	199	Crown wheel & pinion	212	Fog lights	64
Brake fitting kit	198	Crown wheel & pinions, heavy-duty	121	Friction modifiers	255
Brake fluid	254	Cubby boxes	109-111	Fridge freezers	312-314
Brake hose kits	224	Cup holder	109	Front Runner roof racks	35
Brake hoses	148	CV joint grease	255	Fuel burning heater	302, 305
Brake kits	198	CV joints	213	Fuel cooler guard	23
Brake lubrication	198	Cylinder head overhaul kits	204	Fuel filter - 2 micron	204
Brake pads, DTEC	146	Cylinder heads	204	Fuel filter clasp fixing kit	204
Brake pads, EBC	147-148	Cylinder liner kit	204	Fuel filter holder	207
Brake pads, XD	200-201	Damper & bearing kit	212	Fuel filter valve repair kit	208
Brake pads, XS	200-201	Dash cameras	334	Fuel latch repair	240
Brake pipe bending tool	198	Deflectors, wind	24	Fuel pump repair kit	204
Brake pipe sets	198	Degreasing fluid	256	Fuel tank fitting kit	240
Brake pipe swivel mount bracket	230	Demister kit	285	Fuel tank guards	22



<i>Part Number</i>	<i>Page Number</i>	<i>Part Number</i>	<i>Page Number</i>	<i>Part Number</i>	<i>Page Number</i>
Fuel tanks, extended	123	Leaf springs	180	Polyurethane bushes	170
Fulcrum brackets	164	LED bumpers	72	Portable PowerPacks	331
Fume curtain	113	LED headlights	75, 77	Potentiometer kit	208
Fuse box screws	285	LED interior festoon bulbs	73, 80	Power steering fluid	252
Fuse distribution block	284	LED lights	74	Power steering rack pipes	197
Gaiter kits	23	LED Lights	66-67	Power steering reservoir cap	205
Gaiters	115	LED map light	80	Powerflex bushes	168
Galvanised products	228-231	LED registration plate light	73	Powerlite starter motors	152
Galvanised roof racks	35	LED strip lights	80	PowerPacks	331
Gasket sets	206	Lift rod kit	168	Pressure relief valve	208
Gear box gaiters	115	Lifted springs	177	Programmable wiper relay	203
Gear change kits	214	Light bars	64	Propshaft bearings	212
Gear lever knobs	286	Light conversions	73-80	Propshaft bolt kits	186
Gear lever replacement spring	212	Light guards	13-17	Propshaft fastener tools	269
Gearbox bearings	213	Light kits	75	Propshaft spacers	186
Gearbox/axle filler pump	269	Light mounting kits	77	PRORAM induction kit	149
Gearboxes	212	Light mountings	64	Protection, rear	18
Girling brake hose kits	224	Light upgrades	73-80	PSI Tuning	155
Girling clutch hoses	224	Lights, driving	64	Pulleys	137
Girling shock absorbers	224	Lights, fog	64	Puncture repair kit	58-59
Glass fitting kit	240	Lights, LED	74	Quick release handle kit	238
Glove boxes	115	Lights, spot	64	Quick release security lock	292, 333
GPS tracking	332	Link assembly anti-roll bars	165	Radiator hose kit	208
Grab handles	285	Load securing system	46	Radiator muffs	333
Grease	252	Loadspace covers	94	Radius arms	165
Grease nipples	264	Loadspace liners	93-95	Raised air intakes	128
Grille spot light integration kits	68-69	Loadspace mats	93-95	Ramp, dog	91
Ground anchors	127	Loadspace nets	102	Raptor aerosols	257
Guards, dog	90-92	Loadspace protectors	93-95	Raptor protective coating	258-259
Guards, light	13-17	Loadspace retention kits	102	Ratchet straps	102
Hand sanitiser gel	255	Locking door catch buttons	238	Ravenol Classic oils	249
Handbooks	328	Locking fuel cap	332	Ravenol workshop consumables	250-254
Handbrake conversion	149	Locking wheel nuts	55	Re-trim kits	108
Handbrake shoes	200	Loctite consumables	262	Rear diff & carrier	214
Hawse fairleads	136	Long range fuel tanks	123	Rear diff assemblies	214
Haynes manuals	328	Low profile roof rack	37	Rear protection	18
Head bolt sets	206	Lowered springs	178	Rear shock droppers	167
Header tanks	150	Lubegard	255	Rear silencers	159
Headlight bulbs	78	Lucas Classic parts	218	Rear steps	29-30
Headlight protectors	13-15	Luggage rails	102	Rear window surrounds	112
Headlights	77	Lynx Evo diagnostics interface	190-191	Recovery kits	122
Heated mirror kit	16	Lynx Eye LED headlights	75	Remote control Defender	336
Heated seats	114	Lynx Halo	76	Remote reservoir shock absorbers	173
Heated windscreen	284	Lynx replacement parts	192	Replacement headlights	77
Heater blower motor kit	210	Mach 5 wheels	51	Replacement lens covers	78
Heater control light upgrade	73	MagBooks	329	Replacement surround cameras	18
Heater deflector	285	Main bearing sets	207	Revotec electric fans	154
Heater hoses	153	Manifold assembly fuel sensors	206	Richards chassis	226
Heater matrixes	210	Manifold inlet seal	206	Ride on suitcases	337
Heater plug upgrade kit	207	Manifold links	206	Roamerdrive	160
Heavy-duty drive flanges	164	Map light	80	Rock sliders	19
Heavy-duty shock absorbers	176	Marsland chassis	227	Rockers	208
Heavy-duty steering arms	186	Mats	96-99	Roll cages	42-44
High brake lights	74	Maverick diagnostics	193	Roller fairleads	136
High output heater matrix	152	MaxTrac wheels	51	Roo-Lites	65
Hinges	239	Merchandise	335-342	Roof bars	35, 41-42
Hood sticks	113	Metalik paste	261	Roof console	290
Hoods	113	Meyle bushes	165	Roof rack ladders	45
Hub assembly	196	Meyle heavy-duty	165	Roof racks	34-44
Hydraulic jack	125	Mirrors	16	Ropes	136
Hylomar consumables	262	Model engine	335	Rubber mats	96-98
Ignition conversion kits	202	Monroe shock absorbers	176	Safari snorkel	128
Ignition lead sets	202	MT82 repair kit	213	Safety Devices roll cages	42-44
Ignition module	202	Mudflap brackets	231	Safety Devices roof racks	36-37
Injector pipe sets	207	Mudflaps	17	Sand ladders	126
Injector seal kit	208	NAS lights	74	Scale models	340
Injector washers	207	Navigator camping gear	324	Screw kits	297
Inlet manifold	207	Number plate mounting bracket	142	Seal kits	238
Inlet manifold fitting kit	206	Nuts & bolts, tamper proof	12	Seat belt anchorage frame	46
Inner tubes	58	Oil analysis kit	252	Seat belt stress plate	114
Inspection lights	274-275	Oil cooler repair kit	208	Seat belts	114
Intercooler hoses	153	Oil filler cap	205	Seat box protectors	112
Intercoolers, performance	152	Oil filter tools	267	Seat covers	100-102
Interior festoon bulbs	73, 80	Oil pump	208	Seat handle	108
Interior light	283	Oil pump gear set	208	Seat heater kits	114
Interior roof consoles	290	Old Man Emu bushes	175	Seat rails	114
Interior trim	111-112	Old Man Emu shock absorbers	175	Seat re-trim kits	108
Interior trim panels	112	Old Man Emu springs	179	Seats	104-111
IRD repair kit	213	Optima batteries	140	Seats, Corbeau	107
Isolator switch	138	Optimill enhancements	292-293	Seats, Sparco	107
Isonon repair consumables	261	Original technical publications	330	Security box	109
Jack accessories	125	Otter switch upgrade	202	Security equipment	332-334
Jack bases	125	Outrigger mud shields	23	Security marking kit	332
Jack clamps	125	Overdrive units	160	Service kits	242-245
Jackall jacks	125	Paint pens	257	Service sticker	245
Jacks	125-126	Panhard rods	164	Shackles	137
Jerry cans	123	Parabolic spring kits	181	Shelter/shade	314-318
Jubilee clips	264	Parabolic springs	181	Shims, anti-squeal	198
Key fob batteries	202	Parking actuator repair kit	198	Shock absorber brackets	167
Key fob repair kit	202	Parking brake springs	198	Shock absorber turrets	167, 173
Ladders	35-36, 45	Parking sensor kit	18	Shock absorber washers	176
Land meters	124	Parts catalogues	328	Shock absorbers	173-178
Land Rover merchandise	337-340	Performance air filters	151-152	Shock absorbers, Girling	224
Land Rover roof racks	35	Performance brake discs	144-145	Short oil filter	208
Landy books	329	Performance brake kits	145	Side protection	19-22
Lazer spot lights	68, 69	Piston ring sets	207	Side protector tubes	28
Lead replacement additives	254	Pistons with ring sets	207	Side protectors	20
Leaf spring castor correction wedges	180	Polybush sets	169	Side steps	28-31

<i>Part Number</i>	<i>Page Number</i>	<i>Part Number</i>	<i>Page Number</i>	<i>Part Number</i>	<i>Page Number</i>
Sit on Defenders	336	Swivel housing kits	213	Valve caps	58
Skytag	332	Swivel housings, castor corrected	164	Valve unit	210
Slings	136	Swivel oil seal retainers	196	Vent hinge pins	280
Smoked lights	73	Swivel pin kits	196	Vent knobs	285
Snatch block	137	T-shirts	335	Voltmeter gauge	282
Snorkels	128	Table, camping	319	Waffle boards	126
Snow cows	279	Tailgate chain cover	115	Water housing kit	208
Sockets	267	Tailgate conversion trim kit	301	Water pumps	209
Sound deadening	294	Tailgate half door	240	Water sensor repair kit	208
Spacer blocks	168	Tailgate hinge brackets	240	Waterless coolants	256
Spade bulb	73	Tamper proof nuts & bolts	332	Waterproof seat covers	100-102
Spanners	267	Td5 alloy intake pipe kit	152	Watts linkage bush	169
Sparco seats	107	Td5 oil pump	208	Weber carburetors	155
Spare light bulbs	78	TdV6 engine parts	208	Wheel adaptors	54
Spare tyre storage	321	Technical publications	330	Wheel arch cladding	240
Spare wheel carriers	61	Techno style seats	104	Wheel arch kits	20-21
Spare wheel covers	56	Tent mount fit kit	318	Wheel bearings	197
Spare wheel protectors	56	Tent shoe pockets	318	Wheel carriers	61
Spare wheel strap	61	Tents	314-318	Wheel chocks	138
Speedo Healer	58	TetraBOOST	255	Wheel hub assemblies	197
Split charge relay	141	Thule roof bars	41	Wheel Nuts	54-55
Sport seats	104	Tie down point	102	Wheel protection	54-56
Spot lights	64	Tiger Seal	261	Wheel spacers	54
Spring kit, parking brake	198	Timing belt & chain kits	209	Wheel valve caps	58
Spring retainers	167	Timing tools	266	Wheel wrenches	58
Spring seats	168	Toastie brander	314	Wheels	50-56
Spring spacer blocks	168	Toiletries bag	322	Wide angle propshafts	186
Springs, air	179	Tool roll bag	323	Winch accessories	136-141
Springs, coil	178-180	Top hat liner set	208	Winch accessory kits	138
Springs, leaf	180	Torches	320	Winch bumpers	134-136
Springs, lifted	177	Touch up paint pens	257	Winch remote control	138
Springs, lowered	178	Towing equipment	82-88	Winch ropes	136
Springs, Old Man Emu	179	Towing hitches	82	Winch safety equipment	138
Springs, parabolic	181	Trade tack stab	254	Winch shackles	137
Stabiliser link bars	165	Transfer boxes	214	Winch spare parts	133
Stainless steel fixings	297	Transmission flush & fill	273	Winch tray	135
Starter motors	152	Transmission oils	249, 251	Winches	130-135
Starting handle	334	Trasharoos	321	Wind deflectors	24
Steel wheels	53	Travel kits	122	Windbreaks	315
Steering arms	186	Tree sliders	19	Window catch assembly	238
Steering box repair kit	197	Trim clips kit	264	Window guard kits	23
Steering dampers	174, 186	Trim removal tool kit	269	Windows	232-235, 240
Steering rack ball joint repair kits	196	Trim, dash	111	Windscreen wiper motors	203
Steering wheel bosses	292, 333	Trim, door	111	Wing mirrors	16
Steering wheels	291	Truetrac lockers	121	Wings	232-235
Steps, rear	29-30	Tuning box	155	Wiper blades	334
Steps, side	28-31	Tuning products	155-156	Wiper relay	203
Stockist merchandise	342	Tunit box	155	Work lights	79-80, 274-275
Storage boxes	321	Turbo Boost Box	155	Workshop consumables	263
Stormproof bags	322	Turbo hoses	153	Workshop manuals	328
Stretcher/bed	319	Turret rings	167	Wynn's TranServe	273
Strip lights	80	Tyre balancing beads	59	X-Column	332
Strops	136	Tyre inflators	118	X-Defend pedal lock	332
Stub axle kits	196	Tyre maintenance	60-61	X-Trouser	288
Stud Kleen	58	Tyre repair	122	XD brake pads	200-201
Subframe arms & bolt kit	165	Tyre repair kit	58-59	XD brake shoes	200
Subwoofer	282	U-Pol Tiger Seal	261	XD handling kit	178
Sump guard/plates	22	Umbrella holder	102	XD oil	248
Super Gaz, shock absorbers	174	Unbreakable mirrors	16	XD remote reservoir shock absorbers	173
Suspension arms	166	Underside protection	22-24	Xenon headlight bulbs	78
Suspension ball joint repair kits	196	Universal joint silicone sleeves	23	XS brake discs	199
Suspension bolt kits	196	Universal spot light harness	64	XS brake pads	200-201
Suspension bolts	166	Upgrade chips	155	XS Half axle shafts	165
Suspension kits	184-185	USB charger	284	XS Lynx auxiliary lights	65
Suspension mounts	233-236	USB extension socket	282	XS water pumps	209
Swivel housing gaiter kits	23	USB socket	282	Zu wheels	52
Swivel housing grease	254	Utility link pipes	159		



Photo by Glen Eves











Available from:

**BRITPART**

**The quality parts for Land Rovers**

The Grove  
Craven Arms  
Shropshire  
SY7 8DA  
United Kingdom